

Hard facts. Clear stories.

Copenhagen
Economics

CE

DISTRICT HEATING TARIFFS IN EUROPE

Comparison of tariffs and regulation in Europe

MINISTERIE VAN ECONOMISCHE
ZAKEN EN KLIMAAT
6 APRIL 2021

AUTHORS

Sigurd Næss-Schmidt
Holger Nikolaj Jensen
Jasper Lutz

PREFACE

Comparison of district heating tariffs in the Netherlands and four other European countries

The Dutch Heat Act (*Warmtewet*) is currently being reformed into the *Wet collectieve warmtevoorziening*. District heating networks can contribute to a large extent to making the built environment more sustainable. In this context, the Dutch Ministry of Economic Affairs and Climate Policy (*Ministerie van Economische Zaken en Klimaat*) has initiated research requested by the Dutch parliament (*Tweede Kamer*) to compare existing district heating tariffs in Germany and other European countries. The research also sheds light on the drivers of differences in district heating tariffs for customers, but it does not suggest what the effects could be of potential future district heating technologies.

The Dutch Ministry of Economic Affairs and Climate Policy has assigned Copenhagen Economics to contribute to this research by comparing the Netherlands to four other European countries. Specifically, we have been asked to find answers to the following three questions:

- 1) Which European countries can be compared to the Netherlands regarding district heating?
- 2) How do district heating tariffs relate to each other in the Netherlands and in the identified European countries?
- 3) What are the reasons for variations in district heating tariffs between the Netherlands and the identified European countries? Potential drivers are technology, fuel prices, taxes, and the regulatory framework.

To answer these questions, we present this report which is structured accordingly in three chapters.

TABLE OF CONTENTS

Preface	0
Executive summary	5
Dutch Executive Summary	8
1 Choosing benchmark countries	11
1.1 Three criteria to identify countries relevant for comparison to the Netherlands	11
1.2 Four countries are selected as comparison to the Netherlands	12
1.3 Regulatory structure	14
2 Comparing district heating tariff levels and structures across benchmark countries	16
2.1 Composition of district heating tariffs	16
2.2 Level of tariffs	17
2.3 Costs of district heating from a household perspective	19
2.4 Customer satisfaction	22
3 Comparing cost drivers of variable tariffs across benchmark countries	24
3.1 Variation in technologies, fuel inputs, and prices	24

3.2	Estimated heat production costs and variable tariffs	27
3.3	Conclusion: impact of technology, fuels, and regulation on variable and fixed costs of heat production	28
4	Appendix A. Technical model description	29
5	Appendix B. Data for analysis	33

LIST OF TABLES

Table 1 Assessment of comparability of selected European countries	13
Table 2 Regulation of district heating	14
Table 3 Allocation of cost components to district heating tariffs in Denmark	17
Table 4 Excerpts customer satisfaction district heating	23
Table 5 Data coverage	33

LIST OF FIGURES

Figure 1 Fixed tariff shares of district heating tariffs	18
Figure 2 Variable district heating tariff and its spread per country	19
Figure 3 Average annual heat consumption per household	20
Figure 4 Average annual district heating costs per household	21
Figure 5 Average annual district heating costs benchmarked against median disposable income	22
Figure 6 Composition of fuels for district heating	25
Figure 7 Fuel input prices for district heating	26
Figure 8 Actual variable tariff for district heating versus estimate of heat production costs	27

EXECUTIVE SUMMARY

Question 1: Choosing benchmark countries

To do a comparative international analysis of the district heating system in the Netherlands, we first identify the benchmark countries based on objective criteria. We consider several aspects for selecting countries for a benchmarking exercise.

First, we focus on EU countries located in North-Western Europe. As EU Member States, the compared countries operate under the same fundamental legislation relating to energy taxation, state aid, and to a wide degree share common overall climate and energy policies.

Second, we focus on two criteria to select the relevant countries for comparison from North-Western European countries, namely:

- Geographical representativeness: Geographical conditions are a large determinant of the feasibility and economics to install district heating networks. The main geographical conditions include climate zone, urbanisation rate, and the number of heating days.
- Maturity of the market: A good indicator of the maturity of the market is the percentage of the population connected to a heat network.

Based on these two criteria, we selected Germany, Denmark, Sweden, and the UK for comparison with the Netherlands. For these countries, we focus on the key characteristics of regulation and notably on the most important differences.

Our research shows that only the Netherlands and Denmark have specific price regulation for district heating. Sweden has a soft obligation of transparency in contracts offered to customers as well as metering techniques. In Germany there is likewise no price regulation, and only 10 per cent of the market is covered by an obligation to connect. Neither is there any official price regulation in the UK, though the non-profit organisation for district heating provides guidance on fair pricing through the so-called “Heat Trust”. In absence of data for the UK, we could not provide solid conclusions about this country. Whenever data for the UK is available and reliable, we have included it.

Question 2: Comparing district heating tariff levels and structures across benchmark countries

District heating tariffs are divided into two components: the fixed and the variable tariff. The fixed tariff, based on the experience from Denmark, covers transport costs, e.g. costs associated with the grid. Based on data covering important areas for district heating in the Netherlands, Germany, Denmark, Sweden, and the UK, we find that fixed tariffs vary significantly. These differences are mainly driven by variations in the density of the grid, measured as the number of customers relative to the length of the grid (linear heat density).

The variable tariff covers costs associated with heat production, such as depreciation and return, as well as fuel, wage, and similar costs. We find that variable tariffs, as those presented in publicly available sources, are highly uniform for district heating systems with comparable heat sources, with a variation of 15 per cent between the lowest to highest tariffs.

Customers are satisfied to highly satisfied with the district heating service offerings in most compared countries. However, in the Netherlands, we also see some scepticism in the public debate on new district heating projects, which can be a potential barrier for expanding district heating. We want to highlight here that the metrics for customer satisfaction are somehow subjective and not consistently measured and monitored along the years in the Netherlands. It is therefore not straightforward to draw clear conclusions about the satisfaction of district heating customers in the Netherlands.

Question 3: What explains levels and the variation of levels of variable and fixed district heating tariffs across the benchmark countries?

To understand the level and variation of district heating tariffs it is important to understand the underlying drivers of the costs of producing district heating and delivering that to the customers in the benchmark countries. In Denmark, the variable tariffs reflect heat production costs, whilst the fixed tariffs reflect the transportation and distribution costs. We assume that the cost coverage of the tariff composition in Denmark is also applicable for the other examined countries. There is no data available for the Netherlands to verify this assumption. In this context it is important to be aware that technologies used to produce district heating are very different across the benchmark countries. In the Netherlands, district heating systems are predominately fuelled by natural gas, while e.g. biomass as a fuel input is much more important in Denmark. Our benchmarking exercise focuses on natural gas combusted in CHP plants, separate biomass boilers, as well as coal power plants for the case of Germany. These technologies provide a sufficient coverage for the existing systems in the examined countries.

In other words, the fact that variable tariffs in the benchmark countries exhibit small differences does not necessarily imply that variable costs in the benchmark countries are also the same. It is certainly possible that *costs* differ whereas *tariffs* are similar because differences in regulation counterbalance differences in costs.

By modelling the production costs of heat for the most prevalent technologies in the examined countries, we find that these production costs are very close to the observed variable tariffs in the available references. This observation suggests that the variable tariffs reflect to a large extent the heat production costs. This finding also seems to imply that different regulatory regimes of the *variable* tariffs (for instance true-cost regulation vs. a natural gas or electricity price reference) in each country have a limited effect on the final variable tariffs. Hence, the variable tariffs in the examined countries would be quite close to each other if the heat production technology mix were similar, and the fuel prices were the same.¹

This study does not draw the conclusion that differences in price-based regulatory regimes for district heating can explain the differences in variable tariffs. This is caused by the nature of district heating price regulation (or the lack thereof) in most of the examined countries. In addition, there are many other factors, apart from the regulatory price regime, such as heating costs and grid costs, that impact variable district heating tariffs.

¹ This study does not consider the effect of other energy regulations, such as the regulation of gas and electricity prices.

For the *fixed* annual tariffs, the data availability does not allow to provide a complete overview in all the examined countries nor to reach a solid conclusion on the main drivers behind the observed differences. We expect that the fixed annual tariffs are depended on the maturity of the market, expressed as the share of district heating per country, and the district heating network size.

Although the Dutch fixed annual tariffs lie in the middle of the compared countries, it is worth noting that Denmark, with the strictest regulation on both variable and fixed district heating tariffs, has significantly lower fixed annual tariffs than any other country. Besides the strictness of the Danish regulation this can be also explained by the fact that the regulation in Denmark calls for “cost-true tariff structures”, meaning that variable and fixed tariffs should represent the actual cost share for each element in the provision of district heating, i.e. production and transmission costs.

DUTCH EXECUTIVE SUMMARY

Vraag 1: Keuze van referentielanden

Om een vergelijkende internationale analyse van het collectieve warmtesysteem in Nederland te maken, bepalen we eerst de referentielanden op basis van objectieve criteria. We houden rekening met verschillende aspecten voor de selectie van landen voor deze benchmarking opdracht.

Ten eerste richten we ons op EU-landen in Noordwest-Europa. Als EU-lidstaten vallen de vergeleken landen onder dezelfde fundamentele wetgeving over energiebelasting en overheidssteun, en delen zij in grote mate een gemeenschappelijk algemeen klimaat- en energiebeleid.

Ten tweede concentreren wij ons op twee criteria voor de selectie van de relevante landen voor de vergelijking uit de Noordwest-Europese landen, namelijk

- Geografische representativiteit: Geografische omstandigheden zijn in hoge mate bepalend voor de haalbaarheid en de economische aspecten van de aanleg van collectieve warmtesystemen. De belangrijkste geografische omstandigheden zijn klimaatzone, urbanisatiegraad, en het aantal verwarmingsdagen.
- Rijpheid van de markt: Een goede indicator voor de rijpheid van de markt is het percentage van de bevolking dat op een collectief warmtesysteem is aangesloten.

Op basis van deze twee criteria selecteren wij Duitsland, Denemarken, Zweden en het Verenigd Koninkrijk voor een vergelijking met Nederland. Voor deze landen richten we ons op de belangrijkste kenmerken van de regulering en met name op de belangrijkste verschillen in regulering. Uit ons onderzoek blijkt dat alleen Nederland en Denemarken een specifieke prijsregulering voor collectieve warmtesystemen kennen. Zweden heeft een zachte verplichting tot transparantie in de contracten die aan de afnemers worden aangeboden en in de technieken voor het meten van verbruik. In Duitsland is er evenmin prijsregulering en geldt er voor slechts 10 procent van de markt een aansluitingsverplichting. Ook in het Verenigd Koninkrijk is er geen officiële prijsregulering, hoewel de non-profitorganisatie voor collectieve warmtesystemen via de zogenaamde "Heat Trust" richtsnoeren geeft voor een eerlijke prijsstelling. Wegens gebrek aan gegevens voor het VK konden wij over dit land geen degelijke conclusies trekken. Wanneer gegevens voor het VK beschikbaar en betrouwbaar zijn, hebben wij deze opgenomen.

Vraag 2: Vergelijking van tarieven voor en structuren van collectieve warmtesystemen in referentielanden

Tarieven voor collectieve warmtesystemen zijn onderverdeeld in twee componenten: het vaste en het variabele tarief. Het vaste tarief dekt de transmissiekosten, gebaseerd op de ervaringen in Denemarken, d.w.z. de kosten in verband met het net. Op basis van gegevens over belangrijke gebieden voor collectieve warmtesystemen in Nederland, Duitsland, Denemarken, Zweden en het Verenigd Koninkrijk stellen wij vast dat de vaste kosten aanzienlijk variëren. Deze verschillen worden voornamelijk veroorzaakt door variaties in de dichtheid van het systeem, gemeten als het aantal klanten in verhouding tot de lengte van het systeem (lineaire warmtedichtheid).

Het variabele tarief dekt de kosten in verband met warmteproductie, zoals afschrijving en rendement, alsook brandstof-, loon-, en soortgelijke kosten. We stellen vast dat de variabele tarieven, zoals die in openbaar toegankelijke bronnen worden gerepresenteerd, zeer uniform zijn voor collectieve warmtesystemen met vergelijkbare warmtebronnen, met een variatie van 15 procent tussen de laagste en de hoogste tarieven.

Klanten zijn tevreden tot zeer tevreden over het aanbod van diensten van collectieve warmtesystemen in alle de meeste vergeleken landen. Echter, in Nederland zien we wel de nodige scepsis in het publieke debat over nieuwe collectieve warmtesysteemprojecten, wat een potentiële belemmering kan zijn voor de uitbreiding van collectieve warmtesystemen. We willen hier benadrukken dat de meetcriteria voor klanttevredenheid subjectief zijn en dat klanttevredenheid in de loop der jaren in Nederland niet consequent gemeten en gemonitord werd. Het is daarom niet eenvoudig om duidelijke conclusies te trekken over de tevredenheid van klanten van collectieve warmtesystemen in Nederland.

Vraag 3: Wat verklaart de niveaus en de variatie van de variabele en vaste tarieven voor collectieve warmtesystemen in de referentielanden?

Om het niveau en de variatie van tarieven voor collectieve warmtesystemen te begrijpen, is het van belang inzicht te hebben in de onderliggende factoren, die de kosten voor de productie van collectieve warmte en de levering ervan aan afnemers in de referentielanden bepalen. In Denemarken weerspiegelen de variabele tarieven de kosten van warmteproductie, terwijl de vaste tarieven de transport- en distributiekosten weerspiegelen. Wij gaan ervan uit dat de kostendekking van de tariefsamenstelling in Denemarken ook geldt voor de andere onderzochte landen. Voor Nederland zijn er geen gegevens beschikbaar om deze veronderstelling te verifiëren. In dit verband is het belangrijk te begrijpen dat de technologieën die worden gebruikt voor de productie van collectieve warmte zeer verschillend zijn in de referentielanden. In Nederland worden collectieve warmtesystemen voornamelijk gevoed met aardgas, terwijl bijvoorbeeld biomassa als brandstof veel belangrijker is in Denemarken. Onze benchmarking analyse is gericht op aardgas dat wordt verbrand in WKK-installaties, afzonderlijke biomassaketels, en kolengestookte elektriciteitscentrales in het geval van Duitsland. Deze technologieën bieden een voldoende dekking voor de bestaande systemen in de onderzochte landen.

Met andere woorden, het feit dat de variabele tarieven in de referentielanden kleine verschillen vertonen, impliceert niet noodzakelijkerwijs dat de variabele kosten in de referentielanden ook gelijk zijn. Het is zeker mogelijk dat de kosten verschillen terwijl de tarieven gelijk zijn, omdat verschillen in regulering een tegengewicht vormen voor de verschillen in kosten.

Door de productiekosten van warmte voor de meest voorkomende technologieën in de onderzochte landen te modelleren, stellen wij vast dat deze productiekosten zeer dicht bij de waargenomen variabele tarieven in de beschikbare data liggen. Deze vaststelling wijst erop dat de variabele tarieven in grote mate de kosten van warmteproductie weerspiegelen. Dit lijkt ook te impliceren dat verschillende reguleringsregimes van de variabele tarieven (bijvoorbeeld regulering op basis van de werkelijke kosten vs. een prijsreferentie voor aardgas of elektriciteit) in elk land een beperkt effect hebben op de uiteindelijke variabele tarieven. De variabele tarieven in de onderzochte landen zouden dan ook vrij dicht bij elkaar liggen indien de technologiemix voor warmteproductie vergelijkbaar was en de brandstofprijzen dezelfde waren.²

In deze studie wordt niet geconcludeerd dat verschillen in prijsgebaseerde regulering van collectieve warmtesystemen de verschillen in variabele tarieven kunnen verklaren. Dit wordt veroorzaakt door de aard van de prijsregulering voor collectieve warmtesystemen (of het gebrek daaraan) in de meeste onderzochte landen. Bovendien zijn er, afgezien van de prijsgebaseerde regulering, vele andere factoren, zoals productie- en transmissiekosten, die van invloed zijn op de variabele tarieven voor collectieve warmte.

Wat de vaste jaartarieven betreft, kan op grond van de beschikbare gegevens geen volledig overzicht worden gegeven in alle onderzochte landen en kan evenmin een solide conclusie worden getrokken over de belangrijkste drijvende krachten achter de waargenomen verschillen. Wij verwachten dat de vaste jaartarieven afhankelijk zijn van de maturiteit van de markt, uitgedrukt als het aandeel collectieve warmte per land, en van de omvang van collectieve warmtesystemen.

Hoewel de Nederlandse vaste jaartarieven in het midden liggen van de vergeleken landen, is het vermeldenswaard dat Denemarken, met de strengste regulering van zowel variabele als vaste tarieven voor collectieve warmte, aanzienlijk lagere vaste jaartarieven heeft dan enig ander land. Naast de strengheid van de Deense regulering kan dit ook worden verklaard door het feit dat de Deense regulering oproept tot “kostengetrouwe tariefstructuren”, dat betekent dat de variabele en vaste tarieven het werkelijke kostenaandeel voor elk element in de levering van collectieve warmte, d.w.z. de productie- en transmissiekosten, moeten weerspiegelen.

² In deze studie wordt geen rekening gehouden met het effect van andere energieregulering, zoals de regulering van de gas- en elektriciteitsprijzen.

CHAPTER 1

CHOOSING BENCHMARK COUNTRIES

The study at hand compares district heating tariffs and regulation in the Netherlands to selected other European countries.³ To do so, we first identify a set of relevant European countries to compare the Netherlands to.

We identify the relevant countries on the base of two criteria that we present in chapter 1.1. In a subsequent chapter 1.2, we determine where the Netherlands itself is positioned along these criteria, as well as a selection of comparable European countries. At last, we outline the regulatory structures in each country in chapter 1.3.

1.1 THREE CRITERIA TO IDENTIFY COUNTRIES RELEVANT FOR COMPARISON TO THE NETHERLANDS

To select relevant European countries to compare the district heating tariffs in the Netherlands to, we identify a set of two criteria along which to assess the Netherlands and the other candidate countries:

Criterion 1: Geographical representativeness

Geographical conditions are a large determinant of the feasibility to develop district heating networks. Different geographical conditions make it either more or less obvious to develop district heating networks. We work with three criteria with respect to evaluating geographical representativeness:

- **Climate:** Differences in climate reduce the demand for heating, and we will therefore select countries with a climate similar to the Netherlands.
- **Landscape:** A mountainous area e.g. is less suitable for a district heating network than a flat area.
- **Population density:** Higher urbanisation, e.g., and related higher heating demand, results in higher utilisation of the heating infrastructure which in terms results in a higher amortisation of investment costs.

Hence, we are looking for countries that match to the following profile:

- North-Western European countries located in the temperate maritime climate zone, with cool summers and moderate winters like in the Netherlands.
- The Dutch landscape is characterised predominantly by flatlands without significant mountainous terrain. Large agricultural areas dominate the landscape.

³ As a basis for defining district heating, we use the bi-annual Dutch heat report *Warmtemonitor* published by the national bureau of statistics (CBS). It follows the definition of district heating set out by the European Commission. Hence, district heating is defined as the delivery of heat through hot water or steam via any network that delivers heat to two or more customers. (“Voor het bepalen van warmteleveringen zijn we in dit rapport uitgegaan van de Europese definitie voor ‘district heating’, bestaande uit levering van warm water in stadsverwarmingsnetten en levering van stoom in industriële netten. In die definitie van ‘district heating’ gaat het om levering van warm water of stoom via een netwerk dat levert aan 2 of meer klanten. Dat betekent dat een 1 op 1 relaties (bijvoorbeeld een joint-venture die alleen levert aan één fabriek) niet meetelt als district heating.” CBS Warmtemonitor 2019)

- The Netherlands is a densely populated country, especially in the western parts, the Randstad. The urbanisation rate in the Netherlands is 92 per cent.⁴

Criterion 2: Maturity of the market

The maturity of the district heating market has implications for the cost structure. We would expect countries with similar maturities, all else equal, to be more similar with respect to regulatory structure and costs. A good indicator of the maturity of the market is the percentage of the population connected to a heat network. A country with a high percentage of the population connected to a network can be considered to have a market for district heating that is more mature than a country with a low percentage of the population connected to a heat network.

The Netherlands has a less mature district heating market compared to some of the examined countries. Though district heating was introduced in Utrecht already in 1923,⁵ there was a long period of little interest in district heating. Since 1980, interest in district heating in the Netherlands has been steadily growing again. Following the Paris Agreement and the Dutch national climate targets, district heating came back in the picture as a sustainable alternative for natural gas. An example of this transition is the city of Amsterdam where the equivalent of over 80,000 homes are already connected to a district heating network, the city's target is to increase the connection to the network up to 300,000 homes.⁶ In total, the Dutch climate agreement aims to have 1.5 million homes heated with alternatives to natural gas by 2030. 50 per cent of these homes could be heated with district heating.⁷ The ambition of the Netherlands to scale-up collective heating solutions is the reason that not only countries with similar market maturity have been examined in this study, but also countries with a higher maturity that could be considered as examples for the Netherlands.

1.2 FOUR COUNTRIES ARE SELECTED AS COMPARISON TO THE NETHERLANDS

Based on these two criteria and the associated comparison indicators, we find that four countries satisfy these conditions and provide an interesting comparison for the Netherlands, namely Germany, Denmark, Sweden, and the UK. Besides, Germany was an EZK prerequisite based on the request of the Second Chamber. In terms of geography, all five countries have a similar climate with roughly the same number of heating days, the landscape is mostly flat in large parts of the selected countries, and the urbanisation rate is very comparable, see Table 1. In terms of the maturity of the market, there are some differences between the selected countries that help to identify the underlying drivers of district heating costs later.

Data availability for district heating tariffs is very thin for the UK. Although we see value in providing information on district heating in the UK where available, the analysis of the UK case does not

⁴ See Statista, available at <https://www.statista.com/statistics/276724/urbanization-in-the-netherlands/> (accessed on 10 December 2020)

⁵ See e.g. ACM (2009). *Overzicht van grootschalige en kleinschalige warmtenetten in Nederland*, available at https://www.acm.nl/sites/default/files/old_download/documenten/nma/Onderzoek_Warmtenetten_in_Nederland.pdf (accessed on 18 March 2021)

⁶ See RVO magazines, available at <https://www.rvomagazines.nl/eia/2018/01/praktijkverhalen-nuon> (accessed on 18 March 2021)

⁷ See Klimaatakkoord, available at <https://www.klimaatakkoord.nl/documenten/publicaties/2019/06/28/klimaatakkoord> (accessed on 23 February 2021)

contribute to the overall conclusions drawn in this report. Henceforth, we exclude the UK from the representations where necessary.

Table 1
Assessment of comparability of selected European countries

COUNTRY	GEOGRAPHICAL REPRESENTATIVENESS			MATURITY OF THE MARKET	
	Climate and heating days ^{a), e), f)}	Landscape ^{h)}	Urbanisation ^{b)}	District heating systems ^{a)}	Share of connected dwellings ^{a), c)}
Netherlands	Temperate and marine; cool summers and mild winters Heating days: 2,685	Flat	92 %	First system in Utrecht in 1923	6 %
Germany	Temperate and marine; cool, cloudy, wet winters and summers Heating days: 2,801	Flat in the north, similar to NL; hilly in the south	77 %	Early; Berlin has Europe's largest system ^{d)}	14 %
Denmark	Temperate; humid and overcast; mild, windy winters and cool summers Heating days: 3,027	Flat, long coastline	88 %	High maturity already in the 1970's	65 %
Sweden	Temperate in the south with cold, cloudy winters and cool, partly cloudy summers Heating days: 4,100, but highly insulated homes	Flat in the south; mountainous in the north	88 %	Introduction in 1948	52 %
UK	Temperate; moderated by prevailing southwest winds over the North Atlantic Current Heating days: 1,750 ^{g)}	Flat in the south; hilly in the north	83 %	Introduction in the 1960's; district heating in the focus again now	2 %

Source: a) Euroheat & Power Association, available at <https://www.euroheat.org/knowledge-hub/country-profiles/>

b) Worldbank data services, available at data.worldbank.org

c) CBS, available at <https://opendata.cbs.nl/statline/#/CBS/nl/dataset/81528NED/table?fromstatweb>

d) WIK Consulting (2013), available at https://www.wik.org/uploads/media/WIK_Diskussionsbeitrag_Nr_381_01.pdf

e) CIA World Fact Book, available at <https://www.climate-zone.com/continent/europe/>

f) Eurostat, available at https://ec.europa.eu/eurostat/databrowser/view/nrg_chdd_a/default/table?lang=en

g) Croner-I, available at <https://app.croner.co.uk/topics/degree-day-data/indepth#DCAM-1565605>

h) E.g. Google maps

All links accessed on 10 December 2020

1.3 REGULATORY STRUCTURE

For the chosen benchmark countries we have highlighted the main features in regulatory regime. Countries regulate the variable tariffs as well as aspects relating to the district heating network, such as fixed tariffs or the obligation to connect.

There are regulatory differences between the selected countries, see Table 2. In the Netherlands, district heating tariffs are linked to the average gas price. Maximum variable and fixed tariff are set by the regulator ACM and are calculated on the basis of price that a consumer pays for natural gas heating in the Netherlands.⁸ Additional costs for connecting to and disconnecting from a district heating network apply. One part of these costs is regulated and capped with a maximum allowable price (cost coverage contribution “Kostendekkingsbijdrage”). In contrast, cost-recovery is the regulation principle in Denmark.⁹

Table 2
Regulation of district heating

COUNTRY	REGULATION VARIABLE TARIFF	REGULATION NETWORK
Netherlands	Gas price reference; variable district heating tariffs must not exceed price for individual heating with natural gas. The maximum variable tariff is set annually by the ACM.	The maximum annual fixed tariff is set by the ACM; additional costs for disconnection, also regulated by ACM. “Kostendekkingsbijdrage”, the project contribution, is unregulated.
Germany	Unregulated	Only 10 per cent of relevant dwellings fall under the obligation to connect
Denmark	Cost-recovery allowed, including depreciations and interest on original paid-in equity	Cost-recovery allowed, including depreciations and interest on original paid-in equity; additional costs for disconnection
Sweden	Soft transparency obligation; regulation on customer contracts and metering standards for consumer protection	Unregulated. The heating sector initiated the “price dialogue” with the end-consumers to include them in the definition of the DH-tariffs.
UK	Unregulated through voluntarily price control exists through the Heat Trust (NPO for consumer protection and pricing transparency)	Unregulated

Source: NL: Oxera Consulting (2020). *Alternatives to the gas reference price*
 DE: Department for Business, Energy & Industrial Strategy (2020). *Heat Networks: Building a Market Framework* and BEIS Research Paper Number 2019/032, available at https://assets.publishing.service.gov.uk/government/uploads/system/uploads/attachment_data/file/863937/international-review-of-heat-network-market-frameworks.pdf (accessed on 17 February 2021)
 DK: Danish law on price regulation for district heating, available at <https://www.retsinfor-mation.dk/eli/lta/2019/64> (accessed on 17 February 2021)
 SE: Werner, S. (2017). *District Heating and cooling in Sweden*. Euroheat & Power (2019). Lygnerud, K. (2018). *Challenges for business change in district heating*, available at <https://energysustainsoc.biomedcentral.com/articles/10.1186/s13705-018-0161-4> (accessed on 31 March 2021)
 UK: Department for Business, Energy & Industrial Strategy (2020). *Heat Networks: Building a Market Framework*

⁸ See ACM, Zaaknr. ACM/20/039419 / Documentnr. ACM/UIT/545404, p. 35 and following, available at <https://www.acm.nl/sites/default/files/documents/tarievenbesluit-2021-warmte.pdf> (accessed on 24 February 2021)

⁹ See e.g. Huygen, A. (2019), *Innovatieve warmtenetten vragen om een nieuwe marktordening*, available at <https://esb-binary-external-prod.imgix.net/1EbEZIaIbSs19e2uTpZgEqMI-2Q.pdf?dl=Huygen+%282019%29+ESB+4774+272-275.pdf.pdf> (accessed on 24 February 2021)

For the remaining three countries, Germany, Sweden, and the UK, district heating tariffs are largely unregulated. In 2008, Sweden introduced the obligation for district heating providers to be transparent about the contracts they offer to customers and to adhere to certain metering standards. In particular, the district heating industry has initiated a voluntary dialogue with their customers around tariffs. These “price dialogues” are meant to include the consumer in the discussion on the tariffs. In the UK, district heating companies can voluntarily opt for price control via the Heat Trust, an NGO for consumer protection and pricing transparency. In Germany, only 10 per cent of relevant dwellings fall under the obligation to connect.

CHAPTER 2

COMPARING DISTRICT HEATING TARIFF LEVELS AND STRUCTURES ACROSS BENCHMARK COUNTRIES

With the four countries to benchmark the Netherlands identified in chapter 1, this chapter takes a closer look at tariff levels and structures in the five countries. First, we discuss the different components of district heating tariffs (chapter 2.1). Second, we provide an overview of levels and structures of district heating tariffs in the different countries (chapter 2.2). Third, we depict district heating costs from a customer and household perspective (chapter 2.3). Last, we present different indicators for how customers perceive price and quality of district heating services (chapter 2.4).

2.1 COMPOSITION OF DISTRICT HEATING TARIFFS

District heating tariffs in all countries consist of a variable and a fixed share. In Denmark, the variable tariff typically covers costs of heat generation, such as fuel and other running costs, as well as return on and depreciation of the assets used in production of heat. In contrast, the fixed tariff and a potential one-off installation fee tend to be more linked to grid costs, i.e. the costs associated with transportation of heat from the heat production plant to the customer, see Table 3. Heat production costs are generally substantially higher than grid costs, around 90 per cent in the Danish case.¹⁰

As the Dutch district heating market is regulated by a price cap rather than a true cost reflection, there is no data available on the cost components of district heating tariffs.¹¹ For this study we assume that the allocation of costs to tariffs in Denmark is applicable to the other examined countries. When modelling the heat production costs in the Netherlands, based on data as well as several educated assumptions for the heat production per country, we observe that the expected production costs are close to the variable heat tariffs as reported by the three major Dutch providers¹². Based on this observation we expect that applying the cost allocation principle of Denmark (see Table 3) for the Netherlands and the other benchmark countries is a justified assumption.

¹⁰ Copenhagen Economics (2015), Benchmark af fjernvarme, available at https://ens.dk/sites/ens.dk/files/Forsyning/benchmark_af_fjernvarme.pdf (accessed on 24 February 2021). For 568 different district heating systems the costs of producing heat net of grid investment costs were on average around 90% of total costs.

¹¹ See e.g. Huygen, A. (2019), Innovatieve warmtenetten vragen om een nieuwe marktordening, available at <https://esb-binary-external-prod.imgix.net/IEbEZIaIbSs1qe2uTpZgEqMI-2Q.pdf?dl=Huygen+%282019%29+ESB+4774+272-275.pdf.pdf> (accessed on 24 February 2021)

¹² Vattenfall, Eneco, and Ennatuurlijk all list variable tariffs for the delivery of heat, as well as fixed costs for contract (“Gebruiksonafhankelijk tarief”), metering (“Meettarief”), and an installation kit (“Aflverset verwarming en warm tapwater”), see Vattenfall, available at <https://www.vattenfall.nl/producten/stadsverwarming/tarieven-en-voorwaarden/>; Eneco, available at <https://www.eneco.nl/static/files/Algemene-stadswarmtetarieven-01-2019.pdf>; Ennatuurlijk, available at <https://ennatuurlijk.nl/sites/default/files/documenten/Tarievenblad%202019%20ENN.pdf>

Table 3
Allocation of cost components to district heating tariffs in Denmark

COSTS		VARIABLE TARIFF	FIXED TARIFF
Heat production	Capex: return and depreciation	√	
	Opex: fuel costs, wage costs, etc.	√	
Grid system	Capex: return and depreciation		√
	Wage costs, etc.		√
	Installation		√ (sometimes separate charge)

Source: Based on 568 Danish district heating networks, see Copenhagen Economics (2015), Benchmark af fjernvarme, available at https://ens.dk/sites/ens.dk/files/Forsyning/benchmark_af_fjernvarme.pdf (accessed on 24 February 2021)

2.2 LEVEL OF TARIFFS

In the four countries, fixed tariffs vary substantially. Paucity of available data does not allow us to provide a thorough analysis of variations in fixed tariffs across the benchmark countries, and hence we showcase the level of fixed costs by means of eight large district heating systems in the Netherlands, Germany, Denmark, and Sweden, see Figure 1. Further, we omit one-off installation fees for the analysis in this report and regard the annually recurring fixed tariffs as the only relevant component of fixed tariffs. As we do so for all five countries in the analysis, we expect that the comparison between these countries will not be significantly affected.

The showcased fixed tariffs vary from around 270 EUR/MWh for two Danish operators to more than 800 EUR/MWh for a Swedish operator. We would also expect fixed tariffs to vary substantially inter alia due to differences in underlying grid cost drivers such as density of the demand per network.

Figure 1
Fixed tariff shares of district heating tariffs
EUR/year/10kW connection capacity

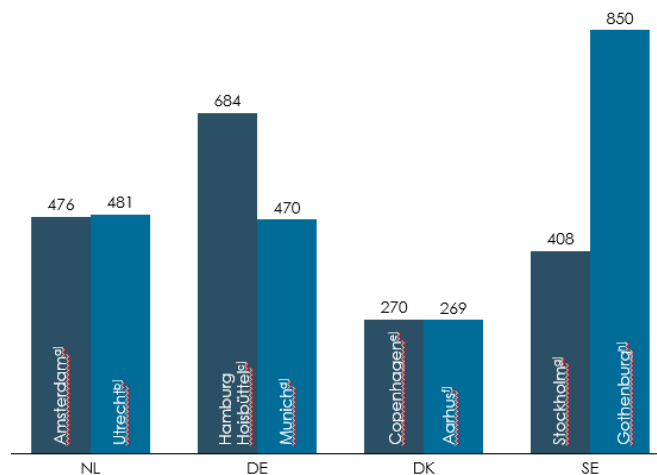

Note: The district heating systems provide a diversified technology mix. Where fixed tariffs are presented per kW connection capacity, a 10kW connection capacity is assumed.

Source: a) Vattenfall, available at <https://www.vattenfall.nl/producten/stadsverwarming/tarieven-en-voorwaarden/>; b) Eneco, available at <https://www.eneco.nl/static/files/Algemene-stadswarmtetarieven-01-2019.pdf>; c) E.ON, available at <https://www.eon.com/de/private-customers/fernwaerme/fernwaerme-infos-pdfs-downloads.html>; d) Stadtwerke München, available at <https://www.swm.de/energie/wende/kraft-waerme-kopplung>; e) Hørfør, available at <https://www.hofoer.dk/privat/priser-paa-forsyning-privatkunder/tidligere-aars-priser/priser-2019-privat/prisen-paa-fjernvarme-2019-privatkunder/>; f) Affaldvarme Aarhus, available at <https://www.affaldvarme.dk/media/tnafipzk/2019-juli-fjernvarmetakster-abonnement-effet-og-forbrug.pdf>; g) Energiföretagen, available at <https://www.energiforetagen.se/statistik/fjarvarmestatik/fjarvarmepriser/>; h) Göteborg Energi, available at <https://www.goteborgenergi.se/foretag/fjarvarme-kyla/fjarvarmepriser-2019>

All links accessed on 10 December 2020.

In contrast, the variation in variable tariffs that cover heat production falls in a narrow range of 85 to 98 EUR/MWh. The highest variable tariff can be found in the Netherlands with almost 98 EUR/MWh while the lowest variable tariff can be found in Sweden with around 85 EUR/MWh, see Figure 2. The analysis is based on data that covers over 75 per cent of customers in the Netherlands.¹³ For the other countries, we use actual country averages, that cover a significant share of the market. In chapter three we examine the extent to which these differences can be attributed to the differences in heat production costs.

¹³ The three energy companies that offer district heating services in the Netherlands, Vattenfall, Eneco, and Ennatuurlijk, served 130,000, 127,000, and 85,000 homes in 2019, respectively. The Warmtemonitor assumes around 450,000 homes to be connected to district heating in the Netherlands. Our data hence covers around 76 per cent of district heating in the Netherlands.

Figure 2
Variable district heating tariff and its spread per country
EUR/MWh

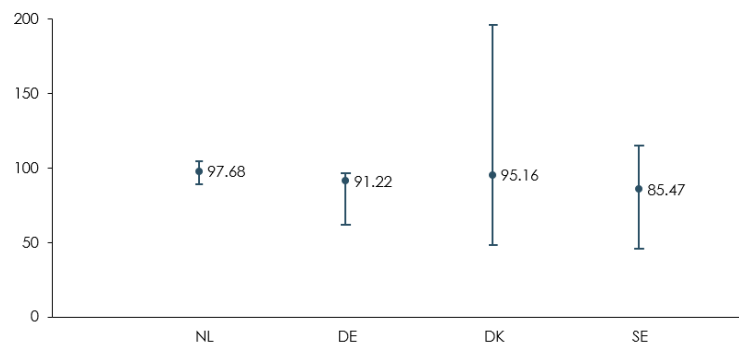

Note: The presented variable tariff shares are country averages. For the Netherlands, the average is weighted with the number of connected households. The average district heating tariffs per country are complemented by an indicator for the range of district heating tariffs.

Source: NL: Vattenfall, available at <https://www.vattenfall.nl/producten/stadsverwarming/tarieven-en-voorwaarden/>; Eneco, available at <https://www.eneco.nl/static/files/Algemene-stadswarmtetarieven-01-2019.pdf>

Ennatuurlijk, available at <https://ennatuurlijk.nl/sites/default/files/documenten/Tarieven-blad%202019%20ENN.pdf>

DE: Heizspiegel Bundesministerium für Wirtschaft und Energie, available at <https://www.heizspiegel.de/heizkosten-pruefen/heizkosten-pro-m2-vergleich/>

DK: Dansk Fjernvarme, available at <https://www.danskfjernvarme.dk/viden/statistik-subsection/varmepristatistik/fjernvarmeprisen-i-danmark-2019#:~:text=Fjernvarmeprisen%20er%2012.859%20kr.%2F%C3%A5r.%C3%A5r%20for%20standardhuse%20i%202019.>

SE: Energiföretagen, available at <https://www.energiforetagen.se/statistik/fjarvarmestatistik/fjarvarmepriser/>

All links accessed on 10 December 2020.

The variable tariff variation within the country is substantially larger in Denmark and Sweden compared to the Netherlands and Germany, as indicated by the vertical lines on either side of the average tariff in Figure 4. For Denmark, the spread is very much driven by a large variation in technologies employed. In Sweden and to a lesser extent in Denmark as well, the spread is likely a result from the larger number of district heating networks in scarcely populated areas with longer distribution pipelines.

2.3 COSTS OF DISTRICT HEATING FROM A HOUSEHOLD PERSPECTIVE

To arrive at an indicator of costs of district heating for an average household, we identify the average annual consumption of heat and combine this with the average district heating tariffs as described above. The calculation is more accurate for the variable tariffs as we have more information with a wide coverage as described above, while the data for the fixed tariffs is thinner. As the variable costs account for a large part of overall costs a customer is charged with, we expect that our calculations provide a good indication of the ranking of cost levels in the five countries.

The average annual consumption of heat per household is comparable across the five countries, see Figure 3. This is expected since the climate of the examined countries is similar. Denmark has the highest annual consumption of heat per household with 18.6 MWh, while the Netherlands and Sweden have the lowest annual consumption of heat per household with 11.5 and 11.4 MWh, respectively. The low heat consumption in Sweden despite many heating days can be explained by the high insulation standards in Sweden.¹⁴ Better insulated homes generally exhibit lower heat consumption compared to less insulated homes.

Figure 3
Average annual heat consumption per household
MWh

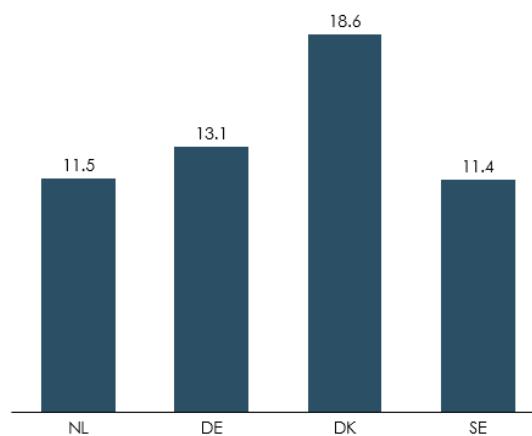

Note: The numbers result from the aggregated demand for space heating and hot water as final energy consumption, divided by the respective number of households per country.

Source: Eurostat, available at https://ec.europa.eu/eurostat/databrowser/view/nrg_d_hhg/default/table?lang=en and https://ec.europa.eu/eurostat/databrowser/view/lfst_hhnhwhtc/default/table?lang=en (accessed on 8 December 2020)

Combining the average annual heat consumption per household with the average district heating tariff per country, we can construct the average annual district heating costs per household, as illustrated in Figure 4. The annual variable costs reflect consumption combined with the average variable tariff share of district heating tariffs, while the annual fixed costs reflect the annual fixed tariff share of district heating tariffs, based on the assumption that the cost-tariff allocation of Denmark can be applied to all the other examined countries.

The average annual district heating costs per household largely mirror the differences in heat consumption presented in Figure 3. This results from the relatively small differences in the variable cost share across the five countries. The average annual district heating costs per household are highest in Denmark at around 2,038 EUR, while the average costs are lowest in the Netherlands at 1,598 EUR, mirroring the relatively high average annual heat consumption in Denmark and the relatively low average annual heat consumption in the Netherlands.

¹⁴ See e.g. Politico, available at <https://www.politico.eu/article/size-and-thickness-do-matter-say-housing-insulation-makers-2/> (accessed 23 February 2021)

Figure 4
Average annual district heating costs per household
EUR

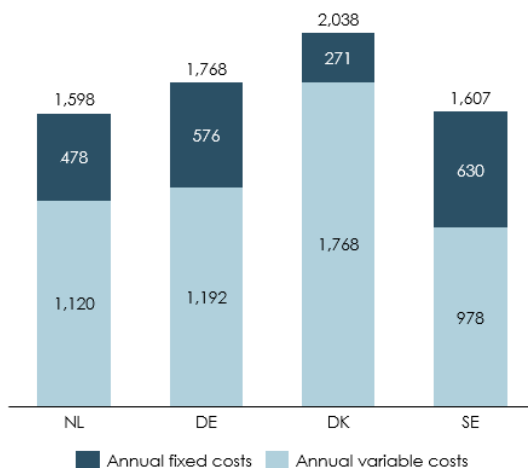

Note: Annual fixed costs are annual contract costs per dwelling for a capacity of 10kW and 130m². We omit one-off installation fees. Annual variable costs represent the average variable tariff per MWh multiplied by the average annual heat consumption per household.

Source: This is a compilation of Figure 1 and Figure 3.

At last, we can benchmark the average annual district heating costs per household against the median disposable income, see Figure 5. This exercise reveals that once we adjust for the difference in disposable income, the actual variation in the share of average annual district heating costs per household diminishes. Concretely, this means that e.g. the relatively high average annual district heating costs per household in Denmark are *offset* by the relatively high median disposable income in Denmark. Relatively low average annual district heating costs in Germany, on the contrary, must be paid by a relatively low median disposable income.

Figure 5
Average annual district heating costs benchmarked against median disposable income
EUR

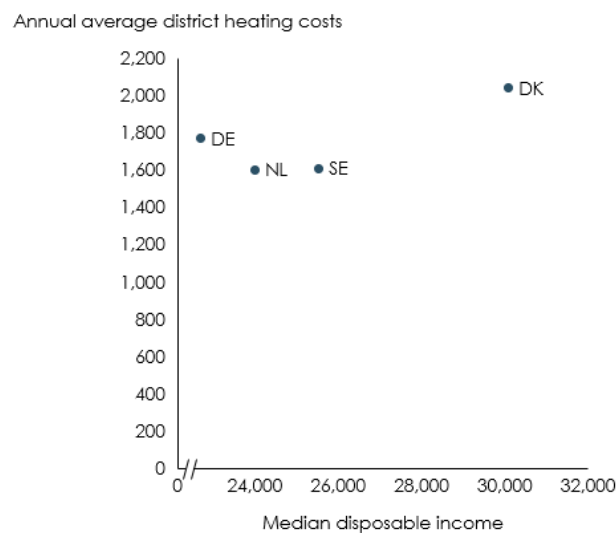

Note: For the data on annual average district heating costs, see Figure 4. We leave the UK out of this illustration because annual fixed costs for the UK are not available.

Source: Eurostat, available at https://ec.europa.eu/eurostat/databrowser/view/ilc_di03/default/table?lang=en (accessed 10 January 2021).

This figure is a compilation of Eurostat data on median disposable income and Figure 4.

2.4 CUSTOMER SATISFACTION

A final aspect to consider when mapping the district heating sector is the customers' perception of district heating. By and large, district heating customers in all five countries express a medium to high level of satisfaction with the services provided by district heating companies, see Table 4.

In Denmark, for example, 85 per cent of district heating customers is very satisfied with their contract for district heating and does not consider changing. Similarly, 75 per cent of district heating customers in the UK are satisfied with their district heating system. Despite the absence of supportive quantitative data, customers in Germany perceive district heating as the preferred heating method. In the Netherlands, customers' satisfaction with district heating networks seems slightly more mixed. Whereas for instance the network in Purmerend is graded a 7.4 out of 10 by customers, there are also critical voices in the Netherlands towards the installation of new and the expansion of existing district heating networks. The excerpts presented here and in Table 4 are indicative. Different customer enquiries employ different questions and target different areas of customer satisfaction within district heating.

Table 4
Excerpts customer satisfaction district heating

COUNTRY	CUSTOMER SATISFACTION
Netherlands	Satisfaction with existing district heating networks is relatively good to good; new projects are confronted with scepticism
Germany	District heating is the preferred heating method
Denmark	85% of district heating customers is very satisfied with their contract; 90% of customers does not consider changing to another source of heating
Sweden	Swedish district heating customers are satisfied for 70%, where 60% is considered very unsatisfied and 75% is considered very satisfied
United Kingdom	75% of UK district heating customers are (very) satisfied with their district heating system; however, only around 20% of 2000 surveyed energy consumers has ever heard of district heating

Source: NL: Stadsverwarming Purmerend, available at <https://www.stadsverwarmingpurmerend.nl/2020/11/26/klanten-geven-stadsverwarming-purmerend-een-74/>; Nationaal warmtenet trendrapport, available at <https://www.warmtenetrendrapport.nl/trendrapport/>
 DE: Krikser et al. (2020), *Willingness-to-Pay for District Heating from Renewables of Private Households in Germany*, available at <https://www.mdpi.com/2071-1050/12/10/4129/pdf>;
 DK: Bolius, available at https://www.bolius.dk/fileadmin/user_upload/undersogelser_og_rapporter/Groen_energi_oktober_2019_V18122019.pdf;
 SE: Kvalitetsindex Sverige, available at <https://www.kvalitetsindex.se/wp-content/uploads/2020/11/SKI-Energi-2020-Helheten-viktigast-nar-kunderna-betygsatter-energibranschen.pdf>;
 UK: Association for Decentralised Energy, available at https://www.theade.co.uk/assets/docs/resources/Heat%20Networks%20in%20the%20UK_v5%20web%20single%20pages.pdf
 All links accessed on 9 January 2021

CHAPTER 3

**COMPARING COST DRIVERS OF VARIABLE
TARIFFS ACROSS BENCHMARK COUNTRIES**

In chapter 2, we concluded that the levels of variable district heating tariffs where data is available have relatively small differences in the five examined countries. The question we pose in this chapter is whether this is a coincidence *or* reflecting actual similarities in the average overall costs associated with the production of heat. In the latter case, this could provide an indication that variable district heating tariffs in the five countries are on average reflecting actual production costs.

To test this, we first describe the variation of energy systems, including technologies and fuels, for producing district heat in the five countries (chapter 3.1). Second, we test whether a potential variation in energy systems would a priori lead to more or less variation in average variable tariffs than what we have observed (chapter 3.2). We have done this by constructing a model that explains the costs of producing district heat (explained in Appendix A). Based on this, we provide final conclusions on the link between costs and variable tariffs across the five countries.

**3.1 VARIATION IN TECHNOLOGIES, FUEL INPUTS, AND
PRICES**

District heating systems in the five countries are highly divergent in the choice of fuel inputs and technology, see Figure 6. In the Netherlands, natural gas is by far the most popular fuel in district heating plants (62 per cent for large district heating plants), with equal shares for biomass and waste (around 20 per cent each). The UK exhibits a similar high usage of natural gas (67 per cent), whereas the other countries have a lower share of natural gas in district heating plants. In Germany, gas is the primary source for district heating (42 per cent), while especially coal (24 per cent) and biomass (20 per cent) are also popular. In the Nordic countries Denmark and Sweden, biomass plays a more significant role (59 per cent for Denmark and 43 per cent for Sweden, respectively).

Figure 6
Composition of fuels for district heating
Per cent

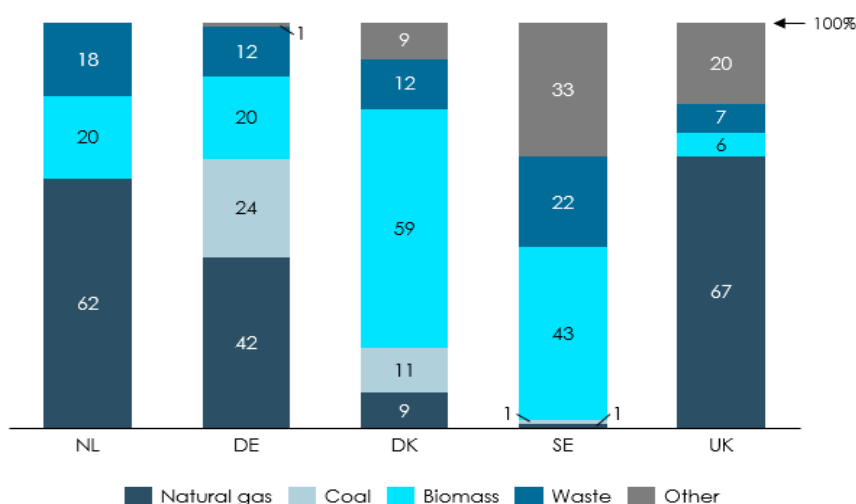

Note: For the Netherlands, the composition is based on large networks, excluding smaller networks, see Warmtemonitor. Other fuels consist of oil, heat pumps, industrial excess heat, and flue gas condensation.

Source: NL: CBS (2019), *Warmtemonitor 2019*

DE: Bundesministerium für Wirtschaft und Energie, available at <https://www.bmwi.de/Redaktion/DE/Bilder/Energiedaten/energiedaten-gesamt.xls.html> (accessed on 10 December 2020)

DK: Forsyningstilsynet, available at https://forsyningstilsynet.dk/media/7241/fjernvarmestatistik-2019_revideret.pdf (accessed on 10 December 2020)

SE: Energiföretagen, available at <https://www.energiforetagen.se/statistik/fjarrvarmestatistik/tillford-energi/> (accessed on 10 December 2020)

UK: Millar et al. (2018), *District heating challenges for the UK*

The choice of technology and hence also input fuel by a district heating provider is an important driver of variation of total heat production costs within the five countries. Both, the input fuel itself as well as the taxation of the fuel contribute to the heat production cost. Hence, two countries with the same energy mix could have different heat production costs if the prices for the same fuel varied e.g. due to differences in the taxation of fuels. Changing supply structures for district heating plants as a reaction to relative price changes of technologies and fuel price changes over time can be costly and time-consuming. However, the final decision is partly defined by national or European targets as well as the corresponding subsidy schemes.

We find that there is variation in the prices of fuels across the five countries. Natural gas prices are by far the highest in Denmark due to a high tax on natural gas to produce district heating while it is more uniform for the other four countries with the Netherlands having the second highest natural gas price, see Figure 7. Wood pellet prices in Germany are higher than in the heavy biomass combusting countries Denmark, Sweden, and the UK.

Figure 7
Fuel input prices for district heating
EUR/MWh

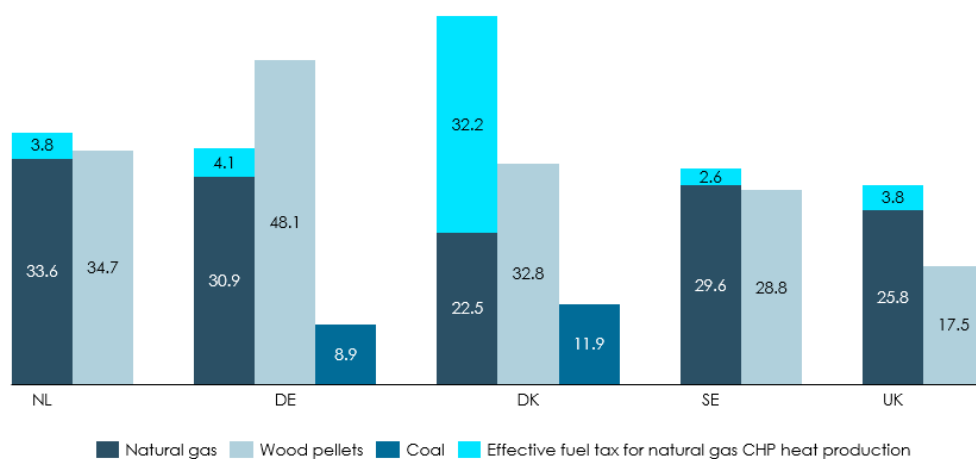

Note: Coal prices are only displayed where relevant. We neglect costs for ETS certificates, because the price for such certificates has historically been insignificant and coal as an input fuel is phasing out.

Source: Eurostat, available at https://ec.europa.eu/eurostat/databrowser/view/nrg_pc_203/default/table?lang=en

PBL, available at <https://www.pbl.nl/sites/default/files/downloads/pbl-2020-klimaat-en-energieverkenning2020-3995.pdf>

Deutsches Pelletinstitut, available at <https://www.depi.de/pelletpreis-wirtschaftlichkeit>

YCharts, available at https://ycharts.com/indicators/northwest_europe_coal_marker_price

Energistyrelsen, available at https://ens.dk/sites/ens.dk/files/Analyser/b1_braendselspriser.pdf

Statistiska Centralbyrån Sweden, available at [https://www.scb.se/content-assets/f3fea1fd8f6040e8b78b9408f49adbc8/en0105_2019a01_sm_en11sm2001.pdf](https://www.scb.se/contentassets/f3fea1fd8f6040e8b78b9408f49adbc8/en0105_2019a01_sm_en11sm2001.pdf)

Forest Research, available at <https://www.forestresearch.gov.uk/tools-and-resources/statistics/statistics-by-topic/timber-statistics/timber-price-indices/>

OECD tax policy overview, available at <http://www.oecd.org/tax/tax-policy/>

All links accessed on 10 December 2020.

The differences in fuel prices, combined with the different technology mix per country, are the reason for the differences in heat production costs between the countries. For Denmark and Sweden, the relatively low prices for wood pellets are particularly important because they are more dominant in the district heating system.

3.2 ESTIMATED HEAT PRODUCTION COSTS AND VARIABLE TARIFFS

In the next step of our analysis we compare the actual observed variable tariffs with what we would expect given the variation in energy systems and input prices for fuels in the four countries where quantitative data is available. This estimation is based on a model representing heat production costs for three subgroups of district heating networks, namely natural gas CHP, biomass boilers, and coal in the case of Germany, weighted by the respective fuel share in each country. It thereby covers a considerable share of district heating technologies in the selected countries, from 44 per cent of district heating networks in Sweden up to 82 per cent of networks in the Netherlands. The model and model assumptions are explained in further detail in Appendix A.

Overall, we note that the heat production costs constructed by the bottom-up model come very close to the observed variable tariffs in the markets. The smallest discrepancy between modelled heat production costs and observed tariffs can be found for Sweden with 1.6 per cent, see Figure 8. For Denmark, the discrepancy is highest with 10.9 per cent.¹⁵ From this result, we can derive that average variable heat tariffs in each country seem to reflect rather well the underlying costs drivers in the production of heat from choice of technology and variations in fuel input costs.

Figure 8

Actual variable tariff for district heating versus estimate of heat production costs
EUR/MWh

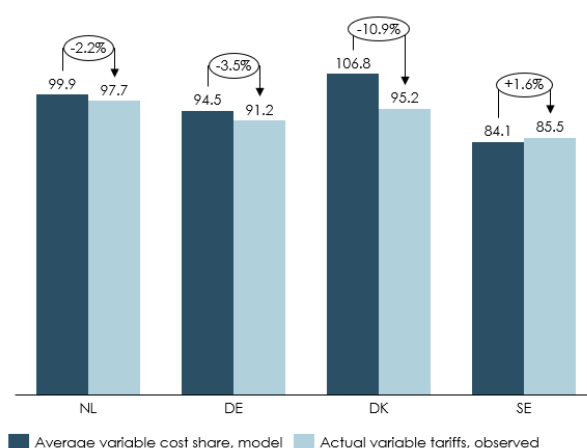

Note: "Variable cost share, model" refers to the variable cost shares as modelled by Copenhagen Economics.
"Actual variable tariff, observed" refers to the actual variable tariffs observed in the markets, cp. Figure 2.
Source: Copenhagen Economics and Figure 2

¹⁵ We identify two reasons for the discrepancy between modelled costs and observed variable tariffs in the Danish case. First, large Danish CHP plants receive a subsidy to run the CHP units, which reduces the charged variable tariffs. Due to uncertainty about and the variance in the exact subsidy scheme, we have not included this scheme in the model. Second, biomass prices in Denmark vary substantially due to regional supply, e.g. on the island Bornholm. We have no full picture of exact biomass prices per district heating plant.

3.3 CONCLUSION: IMPACT OF TECHNOLOGY, FUELS, AND REGULATION ON VARIABLE AND FIXED COSTS OF HEAT PRODUCTION

We have compared variable and fixed tariffs for district heating in four European countries with similar climate and heating days, similar geographic landscape, and urbanisation rate, but different maturities, measured as the share of connected dwelling per country. The fixed district heating tariffs vary between the countries. As various components constitute fixed district heating tariffs, comparing these across countries is not straightforward. Further, the scarcity of data does not allow us to do a breakdown of the relative importance of technology, fuels, and regulation on the relative costs of district heating in the different countries.

The variable district heating tariffs are similar across all four countries. Hence, the differences in total cost for district heating for a household between countries is largely driven by the differences in heat consumption, rather than differences in variable district heating tariffs.

Our overall conclusions on the relation between production costs and variable tariffs for natural gas combusted in CHP plants, biomass boilers, and coal plants across the four countries are the following:

- By and large, the actual observed variable tariffs are relatively close to what one would expect given estimates of the total costs of heat production in the different countries. Modelled estimates of total costs of heat production are slightly higher than observed variable tariffs in Denmark, and to a lesser extent in the Netherlands and Germany, whereas modelled costs are slightly lower than observed variable tariffs in Sweden.
- The conclusion does not include fixed tariffs that cover grid related costs, but this is also a smaller part of the total district heating tariff, see chapter 2.1.
- A priori, the observed variable tariffs are consistent across countries, although the Netherlands and Denmark exhibit slightly higher tariffs than the two other countries.
- Despite the wide variation in heating source mix and input fuel costs, estimated fuel costs for the natural gas combustion in CHP plants and collective biomass boilers are relatively comparable across the four countries, consistent also with the fact that variable tariffs are relatively uniform.
- Observed variable district heating tariffs in all countries are close to expected variable tariffs based on modelled heat production costs. This result seems to verify our hypothesis that the charged variable tariffs at the consumer reflect the actual heat production costs in every country. This result also suggests that differences in *price regulation of district heating systems* do not have a clear effect on variable district heating tariffs. However, this study does not provide evidence that different price regulation regimes for district heating tariffs have *no* impact on overall tariffs.

APPENDIX A

**APPENDIX A. TECHNICAL MODEL
DESCRIPTION****Overall approach**

To identify the drivers of variation in variable tariffs across the selected countries, we build a *bottom-up model*. Such a model is able to capture differences in technologies, efficiencies, and taxes and thus enables us to identify whether variations in variable tariffs reflect similar variation in the costs of heat production. We have not attempted to model variation in fixed tariffs linked to grid costs due to paucity of data.

We use the bottom-up model to construct estimated district heating tariffs for three subgroups of district heating networks:

- Natural gas CHP (with by-pass gas boilers)
- Biomass in collective boilers
- Coal heating plants in the case of Germany

These three subgroups of district heating networks capture 44 per cent for Sweden, around 67 per cent for Germany, Denmark, and the UK, and up to 82 per cent for the Netherlands of the respective district heating markets. Hence, these three subgroups cover a large share of the respective total district heating markets and we can neglect other sources of district heating to simplify.

Using the technical specifications of these three subgroups of district heating networks in the bottom-up model, we can first model the costs that would accrue given the fuel prices, taxation, etc. The model is build based on the methodology described by the Danish Energy Agency.¹⁶ We can then compare the modelled costs to observed tariffs in the respective markets. This allows us to see i) if observed tariffs seem to reflect true costs – or, if not, are overpriced, and ii) what potential differences might stem from, e.g. technology or fuel input mix.

We do so by setting up the model for the Netherlands and the remaining countries, and subsequently running it with input data (fuel prices, taxation, etc.) for the respective countries. This leads to an outcome that shows what the modelled costs of heat production would look like in each country. Based on these results we can understand where the observed cost differences originate from. If the estimated costs are similar to the observed tariffs within the individual markets, we can conclude differences in tariffs between countries are likely a result of different input prices, e.g. for natural gas as well as different composition of heating technologies between the countries.

The assumptions in the bottom-up model for district heating tariffs stem from the technology catalogues published by the Danish Energy Agency.¹⁷ To compile the technology catalogue for district

¹⁶ See Danish Energy Agency (2015), *Teknologikatalog for produktion af el og fjernvarme*, available at <https://ens.dk/service/fremskrivninger-analyser-modeller/teknologikataloger/teknologikatalog-produktion-af-el-og> (accessed on 18 January 2021)

¹⁷ See Danish Energy Agency (2015), *Teknologikatalog for produktion af el og fjernvarme*, available at <https://ens.dk/service/fremskrivninger-analyser-modeller/teknologikataloger/teknologikatalog-produktion-af-el-og> (accessed on 18 January 2021)

heating, the Danish Energy Agency considers various district heating technologies across Europe, and thus does not limit its assessment to Danish district heating networks.

Box 1 Illustration bottom-up model for district heating tariffs

The bottom-up model allows to analyse the differences in district heating tariffs between the countries based on 5 components:

- Technology
- Fuel prices
- Taxes
- Financing
- Regulatory framework

The following illustration shows the model's set up and functionality.

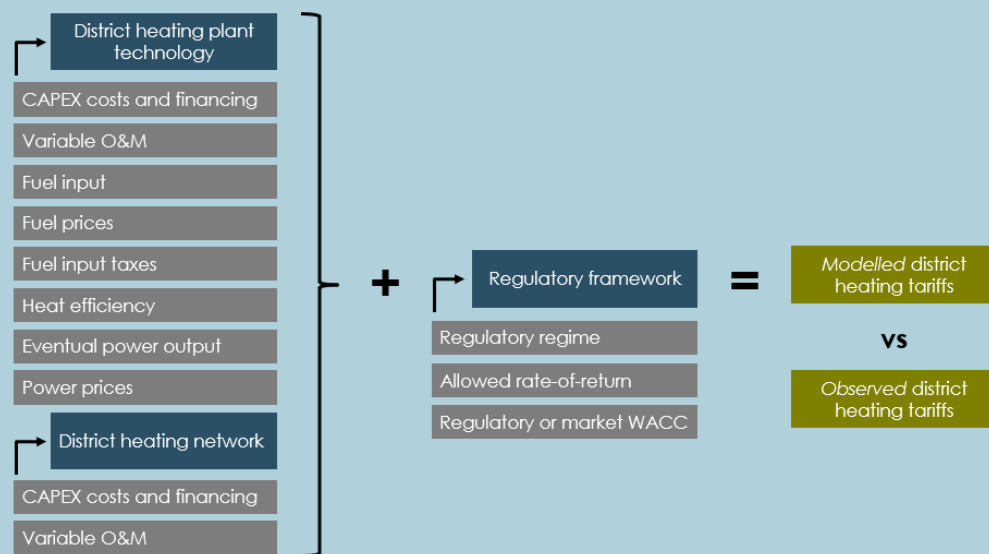

Source: Copenhagen Economics

Technical details

The model is built in Excel. We use technical assumptions from the technology catalogue, see footnote 7. Input data includes:

- Technology data
- Country-specific fuel prices
- Country-specific fuel and CO₂ taxes
- ETS certificate prices
- Electricity prices
- Fixed and variable O&M
- Financial costs

- WACC
- Heating days
- Full load hours

The model represents the economy of a district heating plant that delivers district heat and the cost structure per unit of heat. We calculate the cost of fuels per technology, including fuel taxes, CO₂ taxes, and ETS certificate prices.

For CHP plants, we then deduct the revenue from selling the co-produced electricity on the market.¹⁸ The majority of natural gas and coal plants consist of multiple units. Each plant is equipped with one or more gas boiler units next to the main CHP unit (see example configuration in Figure A.1). CHP production of heat only becomes economically efficient when power prices are above a certain price threshold price. This threshold price is defined as the price at which the electricity revenue can cover the production costs based on the lower heat production efficiency in CHP units compared to boiler units. For each country, the model calculates this threshold price.

Based on electricity price time series, the model then calculates the share of hours for which heat production with CHP is economically sensible. The remaining hours and the by-pass boilers are then be used. This production split is used in the calculation of the average variable tariff, as both production efficiencies and costs differ from CHP and boiler production.

Figure A.1
Schematic illustration of a CHP plant with gas boiler units

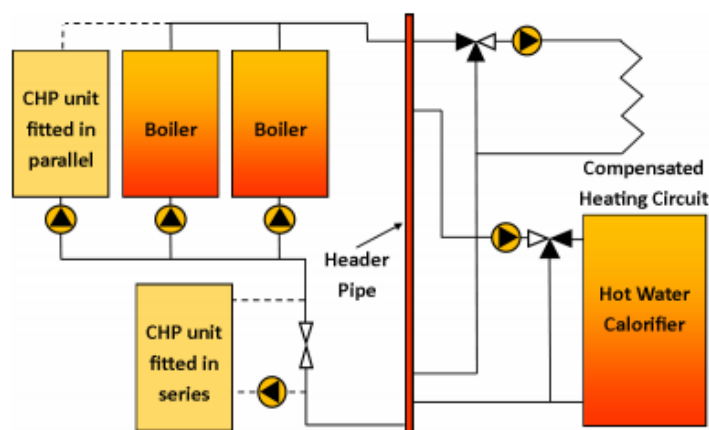

Source: UK Gov (2021). *Combined Heat and Power – Technologies*, available at https://assets.publishing.service.gov.uk/government/uploads/system/uploads/attachment_data/file/961492/Part_2_CHP_Technologies_BEIS_v03.pdf (accessed on 31 March 2021)

¹⁸ Most of the natural gas and coal plants are combined of multiple units, such that each plant both have CHP units and boiler units. CHP production is only economic efficient, when power prices are above a certain price, such that electricity sales can cover the lower heat efficiency in CHP units than the boiler units. For each country, the model calculated this break-even price. Based on power price time series, the model then calculates the share of hours where CHP and boiler production are respectively effective. This production split is used in the calculation of the aver-age variable tariff, as costs differ from CHP and boiler production.

Next, we add average fixed and variable O&M per technology, and finally add the financial cost per unit of heat. The financial cost per unit of heat is calculated by dividing the annual depreciation and weighted average cost of capital with estimated total annual production.¹⁹

These calculations result in the average variable cost per technology. Weighted by the share of the respective technology in a certain country, we arrive at the average variable heat production cost per country. For the total annual production costs, we combine the average variable costs per technology with the number of heating days in the respective countries. For the examined countries, the fuel mix, presented in Figure 6, also applies as input in the model. In particular for the Netherlands this split between the two main fuel inputs is 62 per cent and 20 per cent for CHP with supportive gas-boilers and biomass, respectively.

An example of how the model is applied

The mechanics of the model can be exemplified by looking at how we model the costs of producing district heating in the Netherlands for a natural gas boiler, see Figure A.2. Fuel costs, in this case the price for natural gas, make up approximately 67 per cent of the total variable cost share of district heating tariffs in the Netherlands. The price for emission certificates under the EU ETS adds another large block to the constructed district heating tariffs for the natural gas boiler technology in the Netherlands. Adding variable and fixed operation and maintenance costs, the model constructs a total variable cost share of district heating tariffs for natural gas boilers in the Netherlands of 12.3 EUR/GJ.

Figure A.2
Modelled heat production cost for gas boiler, Netherlands
EUR/GJ

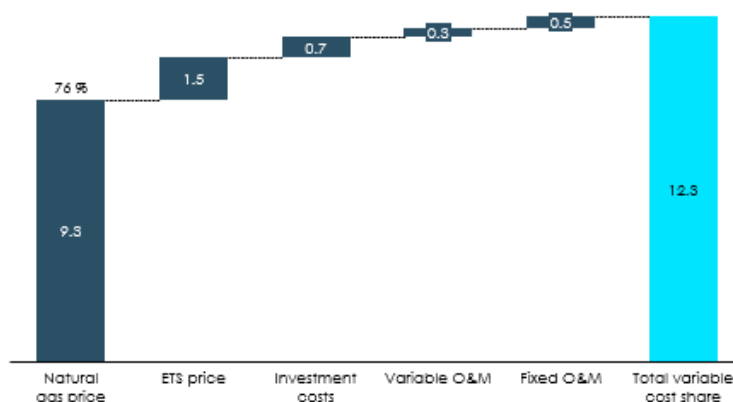

Note: "O&M" refers to operation and maintenance costs. All data stems from the technology catalogue for district heating from the Danish Energy Agency, see footnote 17.

Source: Technology Catalogue Danish Energy Agency, see footnote 17.

¹⁹ The financial costs, i.e. depreciations and rate-of-return per unit of heat are calculated for each country. The basis for these costs is the up-front investment costs and O&M costs. These are initially assumed the same across countries, as district heat technology costs are closely comparable between countries. The main costs stem from boiler and generator technologies and building materials. The boiler and generator technologies and building materials come from a relative few number of producers in Europe and are internationally traded, and they are hence competitively priced.

APPENDIX B

APPENDIX B. DATA FOR ANALYSIS

For the analysis at hand, we present data on variable and fixed district heating tariffs, see Table 5.

For the variable district heating tariffs, we use country averages. Specifically, we use country averages from public energy institutes for all countries but the Netherlands. For the Netherlands, we use an average of the three district heating providers (Vattenfall, Eneco, and Ennatuurlijk) weighted by the number of connected dwellings.

For the fixed district heating tariffs, we use examples of large networks in the respective countries and construct averages out of these examples for quantitative analyses. Various parts constitute the fixed tariffs, such as annual recurring fixed tariffs, measuring fees, one-off installation fees, and fees for the district heating installation kit. Comprehensive data for all these parts is not available on a broad range. Hence, we choose the largest and comparable networks in each country.

Table 5
Data coverage

COST SHARE	COUNTRY	NUMBER OF DATA POINTS	COVERAGE
Variable	NL	3	> 75% ²⁰
	DE, DK, SE, UK	Average	Country averages
Fixed	NL	3	> 75%
	DE	2	Two large German cities
	DK	2	Two largest Danish cities
	SE	2	Two largest Swedish cities
	UK	0	0%

²⁰ The three energy companies that offer district heating services in the Netherlands, Vattenfall, Eneco, and Ennatuurlijk, served 130,000, 127,000, and 85,000 homes in 2019, respectively. The Warmtemonitor assumes around 450,000 homes to be connected to district heating in the Netherlands. Our data hence covers around 76 per cent of district heating in the Netherlands.