



Brussels, 29.1.2014
SWD(2014) 30 final

PART 2/3

COMMISSION STAFF WORKING DOCUMENT

IMPACT ASSESSMENT

ANNEXES 1 - 4

Accompanying the document

Proposal for a Regulation of the European Parliament and of the Council

on structural measures improving the resilience of EU Credit Institutions
and
the Proposal for a Regulation of the European Parliament and of the Council
on reporting and transparency of securities financing transactions

LIST OF ANNEXES

ANNEX A1. Overview of structural reforms and reform proposals - PAGE 2

ANNEX A2. Summary of replies to the stakeholder consultation - PAGE 27

ANNEX A3. Assessing the complementarity of structural separation with the current reform agenda - PAGE 43

ANNEX A4.1. Implicit subsidies: Drivers, Distortions, and Empirical Evidence - PAGE 55

ANNEX A4.2. Size and determinants of implicit state guarantees to EU banks - PAGE 79

ANNEX A1: OVERVIEW OF EXISTING STRUCTURAL REFORM PROPOSALS

The financial crisis has led to an overhaul of the regulatory and supervisory structures governing the financial system in Europe and beyond. These reforms have been coordinated at international level via the G20. However, reforming the structure of banks – i.e. regulatory interventions to directly amend the organisational structure or specific business models of banks – have not been part of this internationally agreed set of reforms. Instead, bank structural reform was initially pursued by those two countries at the epicentre of the early stages of the financial crisis, i.e. the United States and the United Kingdom. Since then, some other countries have followed suit and have adopted or considered to adopt bank structural reform measures (France, Germany, Belgium, The Netherlands, Switzerland). Furthermore, a High-level Expert Group appointed by the European Commission and chaired by Erkki Liikanen has recommended specific reforms of the structure of European banks.

This chapter assesses and compares some of the most mature reform proposals along three dimensions: (i) the activities that are to be separated, (ii) the type of separation and the impact on economic linkages within the banking group, and (iii) the scope of banks it is likely to apply to. Before assessing on-going reforms, an introductory section places these reforms in a historical context by briefly outlining how the different national banking systems have evolved over time.

1. A LONG HISTORY OF EVOLVING BANK STRUCTURES

The debate about reforming the structure of the banks is influenced by the different shapes of national banking systems. That structure largely reflects economic history and the different roles banks have played in financing economic development.

Broadly speaking, banking systems have developed differently in Anglo-Saxon countries compared to continental Europe. In the UK and US the larger financing needs related to industrialisation was predominantly served by capital markets with access to those markets provided by specialised intermediaries (clearing banks in the UK, broker/dealers in the US). Banks were typically small and focused on retail clients. In continental Europe, industrialisation occurred later and substantial amounts of capital were needed to catch up with the industrial forerunners and given that capital markets were less developed, banks became the main source of financing to the large corporates who required a universal set of services. The universal banking model therefore has long historical roots in some countries, whereas in other countries banks were more specialised.

In terms of regulation, approaches have also evolved. In several countries with universal banks, concerns with close links between banks and commerce coupled with the Great Depression saw the introduction of activity restrictions in several countries (e.g. US, IT, BE). However, against the backdrop of the general financial liberalisation and deregulation that occurred from the 1970s onwards, restrictions were relaxed over time due to competitive pressures, perceptions of economies of scope resulting from combining a universal set of activities in one roof and increased faith being put on the ability to manage risks that might arise as a result of these business combinations. Prior to the start of the financial crisis, the universal bank model had accordingly gained prominence internationally.

Box 1: Historical development of national banking structures¹

United States: in the US, prior to industrialisation, banks tended to be small and fragile. As a result, they avoided concentrated lending and preferred arm's length relations. The large scale financing needs related to the growing economy was primarily done via capital markets, with specialised non-bank institutions acting as gatekeepers. This also reflected long-standing restrictions on banks engaging in securities business. At the turn of the century, banks started to consolidate and a national banking system emerged capable of better serving the growing economy. During that process, some banks gained national prominence and became the main providers of funding to the large US corporate trusts. The increasing power of the largest banks and their close integration with the largest corporates provoked an increasing backlash, with e.g. the establishment of the Federal Reserve system in 1913 ending the 'central bank' role provided by the JP Morgan and other large New York banks, and the Sherman Antitrust Act breaking up the trusts and limiting the influence of banks. These changes culminated with the 1933 Glass-Steagall Act, which fully prohibited banks from engaging in securities business. That segmented banking system came under attack in the 1960s, as US commercial banks felt disadvantaged vis-à-vis its competitors both nationally and internationally due to restrictions on their ability to expand their activities. This prompted US regulators to gradually become more permissive as to the extent to which US banks could engage in prohibited activities. In 1999, the Gramm-Leach-Bliley Act finally eliminated the sections of the GSA that prohibited banks from entering into non-banking activities. As a result, US banking groups can organise themselves as financial holding companies, and are then able to provide a universal set of services in different functional subsidiaries.

United Kingdom: the UK until the mid-1980s by and large had a two-tier banking system, with a limited number of nation-wide clearing banks focusing on commercial banking and a number of specialised merchant banks focusing on providing access to securities markets (there were also a number of specialised institutions, such as building societies). The origins of that division of labour can be traced back to the 17th century, when the Bank of England had a monopoly on joint stock banking, small country banks provided local financial services, and London-based merchant banks provided trade finance and placement of government bonds. With the advent of limited liability banking, the small country banks eventually consolidated into nation-wide clearing banks that focused on commercial banking. This focus was not legally imposed but was rather explained by merchant banks occupying the securities market space and commercial banking producing sufficient profit opportunities given the increase in wealth resulting from industrialisation. This system remained stable for most of the 20th century. Following deregulation in the 1960s and 1970s clearing banks began to provide a wider set of services, but their access to investment banking remain hampered by rules of the London Stock Exchange, which required members to specialise either as brokers or market-makers and prevented outsiders from owning a significant financial interest in member firms. Those rules were eliminated in the context of the big bang of October 1986 and as a result, the clearing banks finally also went into investment banking. Since then, the UK banks have provided a universal set of services.

Germany: The German banking system consists of three pillars (private banks, savings banks and cooperative banks) all of which offer a universal set of services. As regards the private banks, they played a central role in the industrialisation process during industrialisation. Given the limited capital markets, banks were the only ones able to pool the amounts of capital necessary and direct it towards the growing sectors of the economy. Commercial banking was eventually dominated by a few large Berlin-based banks that provided a universal set of services to a set of large corporates to which they were closely associated (by banks taking on shareholdings and directorships in the companies they served). Meanwhile, the retail segment was served by local savings and cooperative banks. However, due to their unstable funding structure (e.g. lacking stable retail deposits), the commercial banks suffered heavily during the Great Depression and had to be nationalised (e.g. state acquired 90% of Dresdner Bank, 70% of Commerzbank, and 35% of Deutsche Bank). To address the perception that excessive competition had undermined the solidity of banks, they faced more intrusive regulation (e.g. price caps

¹ For further details about the historical evolution of national banking systems, see e.g. D. Casserley et al (2010), "Should commercial and investment banking be separated: the historical background to the current debate", McKinsey&Company; A.D. Morrison, "Universal Banking", R. DeYoung "Banking in the United States", and J. Goddard et al, "Banking in the European Union" in A.N. Berger et al, *The Oxford Handbook of Banking* (2010); and C.A.E. Goodhart (2013), "The optimal financial structure", *LSE Financial Markets Group Paper Series*, Special paper No. 220, March 2013. Additional specific references are provided as appropriate.

and branching limits) and essentially became closely associated with the stage in the form of a government controlled cartel. Banks were reprivatized in 1936, but continued to be closely linked to the state. After the war, the commercial banks were broken up along geographic lines (one bank per Land) but no activity restrictions were as such imposed. Following the start of the Cold War, the 1950s saw a gradual reconsolidation of the commercial banks, who by the end of that decade were again allowed to reconstitute themselves as national universal banks. In the 1970s, these universal banks were again questioned due to the financial power and lack of competition resulting from these banks' close links with large corporates. However, policy did not change as a result.² However, link between banks and companies have evolved for a variety of reasons (e.g. tax reform making the sale of company stakes more attractive).

France: from the end of World War II until the 1980s, the French banking sector was compartmentalised, with deposit banks on the one hand and banques d'affaires et banques de credit on the other hand. This reflected legal activity restrictions on deposit banks. Large parts of the banking sector were also under public ownership, which was further expanded in the early 1980s. However, the 1984 Banking Act created a single legal and supervisory framework and eliminated activity restrictions, thus paving the way for universal banks. Following this, the French banking sector consolidated rapidly, also exploiting the opportunities for cross-border expansion offered by the European single market. The French banking sector is today dominated by a limited number of large universal banks, some of which have their origins in the savings bank and cooperative banking sectors (BPCE, Crédit Agricole and Crédit Mutuel).

Italy: Italy's financial system was largely bank-based, given that capital markets were thin and illiquid. Similar to Germany, Italian banks developed close ties with large corporates, whom they funded through lending and, increasingly, capital ownership as they developed. The banking system went through a number of crises during the late 19th and early 20th century. In the late 1920s and early 30s most of Italy's universal banks had to be rescued and during those rescue operations, they were forced to divest their industrial stakes and revert to exclusive short-term commercial banking only. These changes were translated into law in 1936, which accordingly effectively separated commercial and investment banking. Similar to Germany, the new law also limited competition by means of e.g. branching limits. The 1936 law contributed to nearly half a century of financial stability and remained in place until the early 1990s. However, this stability came with a price, due to the inefficiencies originated by the limited competition in the Italian banking market. This was compounded by the relevant dimension and market share of publicly-owned banks. Regulatory changes enacted in the 1990s (1990 "Amato-Carli" law, 1993 Banking Law, 1998 "Ciampi" law) privatised and liberalised the banking sector and completed the removal of all the limitations introduced by the 1936 Banking Law, allowing the emergence of universal banks. These changes unleashed a consolidation wave, predominantly domestic in nature.

Belgium: similar to the United States, Germany and Italy, Belgium also saw a policy debate in the wake of the Great Depression regarding the close links between banking and commerce.³ Banks having large holdings of shares in industrial and commercial companies exposed them to concentration risk, which could weaken their retail bank activities. A 1934 decree accordingly required mixed banks to separate their deposit taking activities from their investment banking activities by incorporating the latter into a holding company. However, the retail banks also became subsidiaries of the holding. To further guarantee the independence of deposit taking banks vis-à-vis the holding, a 1935 decree notably prohibited banks from holding shares of industrial and commercial companies with the aim of preventing holding companies from using their bank as a vehicle to indirectly finance their investments. These restrictions were relaxed in the 1960s and 1970s and were eventually abolished in 1993 in the context of the single market paving the way for universal banks.

² Note that the German Banking Act contains a provision on the limitation of qualified holdings in non-financial enterprises for deposit-taking credit institutions (Section 12 of the German Banking Act (Kreditwesengesetz)).

³ For further detail, see National Bank of Belgium (2012), *Interim report: Structural banking reforms in Belgium*, June 2012.

2. UNITED STATES

Whereas nearly all attention as regards structural reform has focused on the Volcker rule, that rule builds on a long US history of bank structural regulation. This section accordingly places a discussion of the Volcker rule in that broader context.

2.1. Existing structural regulation

US structural regulation is built on three pillars that first, separate banking from commerce, second, restricts and isolate the core banking activities within broader financial groups, and third, limits the institutional concentration of the banking and financial sector.

2.1.1. *Separation of banking and commerce*

In the US a company that controls a bank holding company (BHC) cannot engage in activities of a commercial nature, be it directly or indirectly through a subsidiary. This reflects long-standing policy concerns that such combinations could give rise to conflicts of interest, a misuse of banking resources, or the creation of firms that are difficult to supervise. There are a few limited exceptions to this rule, including a de minimis exemption (less than 5% investments in commercial firms) and exemptions made for some grand-fathered firms.

2.1.2. *Restriction and isolation of core banking activities*

During most of the 20th century, the 1933 Glass-Steagall Act 1) separated commercial banking from investment banking, by prohibiting any affiliation between BHCs and firms principally engaged in securities underwriting and dealing. The Act also 2) limited BHCs to a set of core commercial banking activities and other closely related activities (e.g. investment advisory, securities brokerage and leasing). It finally 3) prohibited BHCs from engaging in insurance underwriting and agency activities. These restrictions were substantially liberalised by the 1999 Gramm-Leach-Bliley Act. Under that act, BHCs that meet certain regulatory capital and management criteria may choose to become Financial Holding Companies (FHCs). FHCs are allowed to engage in a broad set of financial activities, including securities underwriting and dealing, insurance underwriting and agency, and merchant banking. However, they are still not allowed to engage in commercial activities.

Nevertheless, structural remnants have remained that restrict and isolate core banking activities. While the banking group (BHC and FHC) may engage in a wide range of financial activities, the insured depository institutions still face activity restrictions that limit their focus to core banking activities (e.g. taking deposits, lending) and other incidental activities (e.g. custody and asset management).

The US also has rules governing transfers between the different parts of a banking group, which are aimed at isolating the insured depository institution from excessive risks arising from the larger financial firm of which it is part (BHC, FHC) and to prevent the transfer of the subsidy arising from federal assistance to non-depository financial institutions:

- Section 23A of the Federal Reserve Act (i) imposes quantitative limitations on certain extensions of credit and other transactions between a bank and its affiliates that expose a bank to an affiliate's credit or investment risk, (ii) prohibits banks from purchasing low-quality assets from their nonbank affiliates, and (iii) imposes strict collateral requirements with respect to extensions of credit to affiliates; Section 23A

has a number of exemptions, the most important one being for transactions that are between banks where 80% of each bank's shares are owned by the same company.

- Section 23B of the same act furthermore stipulates that these and other transactions⁴ between a bank and its affiliates should take place on market terms, i.e. the same terms and conditions as those for non-affiliated companies;⁵ Section 23B excludes banks from the term "affiliate" however. Banks that are part of a chain banking organization are thus exempt from section 23B.
- Regulation W of the Federal Reserve explains and simplifies the interpretation and application of these two acts. The Regulation notably limits a bank's 'covered transactions' with any *single* affiliate to no more than 10% of the bank's capital and surplus and stipulates that overall covered transactions with *all* affiliates cannot exceed 20% of capital and surplus. The regulation also states that loans to affiliates should be fully or over-collateralised.⁶

These requirements have been subject to significant debate. In that context, two issues have been identified:

- Not all transactions were subject to the rule. Section 23A has not applied to derivative transactions. Instead, the Federal Reserve Board required banks to maintain internal policies and procedures for managing derivatives exposures to affiliates. Derivatives were nevertheless included in Section 23B.
- The provisions were not consistently implemented and enforced. The Act grants the regulator (Federal Reserve Board) considerable leeway in interpreting the meaning and scope of application. The Board also has the power to exempt transactions and relationships from the requirements of these provisions, if such exemptions are in the public interest. It has been demonstrated that during the financial crisis, the Board granted numerous financial institutions exemptions from these quantitative and qualitative requirements in order to enable banks to use their deposit-taking subsidiaries as a source of emergency financing for other entities within their corporate structure, thereby preventing the failure of their nonbank businesses and to avert broader market dislocations.⁷

⁴ Examples of other types of transactions include the sale of securities or other assets by a bank to an affiliate, payment of money or furnishing of services by a bank to an affiliate, transactions in which an affiliate acts as an agent or broker for a bank (or for any other person if the bank is a participant in the transaction), and any transaction by a bank with a third party if an affiliate has a financial interest in the third party or if an affiliate is a participant in the transaction.

⁵ This means that each covered transaction must be conducted on terms and under circumstances, "*including credit standards, that are substantially the same, or at least as favourable to such bank or its subsidiary, as those prevailing at the time for comparable transactions with or involving other non-affiliated companies.*" If comparable transactions do not exist, then the transaction must be conducted on terms and under circumstances "*that in good faith would be offered to, or would apply to, non-affiliated companies.*"

⁶ Federal Reserve System (2002), *Regulation W: Transactions between Member Banks and their Affiliates*, 67 FR 76560, December 12, 2002.

⁷ See e.g. Omarova (2011), "From Gramm-Leach-Bliley to Dodd-Frank: the Unfulfilled promise of Section 23A of the Federal Reserve Act", on which the above description builds heavily.

2.1.3. *Limits on market concentration*

US market concentration has historically been limited by e.g. geographic restrictions that limited the ability of banks to establish or buy branches in other states. The 1994 Riegle-Neal Act liberalised these interstate branching limits. To reduce the risk of excessive concentration it imposed a national concentration limit for the deposit market (national deposit cap), prohibiting interstate expansions that would result in one BHC controlling more than 10% of the total deposits of all US insured depository institutions. The Dodd-Frank Act introduced a financial sector concentration limit, which prohibits any firm affiliated with an insured depository institution from expanding if the total consolidated liabilities would exceed 10% of the aggregate consolidated liabilities of all such financial firms.

2.2. **Volcker Rule**

Building on the existing structural regulation, Section 619 of the Dodd Frank Act and its final implementing rule, known as the Volcker Rule, as voted the relevant US agencies on 10 December 2013, further restricts financial groups that contain such institutions from engaging in certain types of market oriented activity (proprietary trading) and also puts significant limits on their investments in hedge funds and private equity funds.

The rule first prohibits any banking entity (i.e. an insured depository institution, any company that controls such an institution, a bank holding company...) from engaging in **proprietary trading**. Proprietary trading activity includes any purchase or sale as principal of any security, derivative, commodity future, or option on any such instrument for the purpose of benefitting from short-term price movements or realizing short-term profits. This activity is judged as incompatible with the appropriate risk profile and customer-driven mission of banking entities.

The prohibition on proprietary trading is subject to exceptions for certain ‘permitted activities’ including market making, underwriting, hedging, organizing and offering a hedge fund or private equity fund and trading in certain government obligations, in particular US government, agency, State and municipal debt obligations and foreign debt instruments under certain conditions. Under these exceptions, banks will be able to engage in market-making activities as long as they prove these activities are aimed at meeting the “reasonably expected near term demands of clients, customers or counterparties”. The final rules exempt, provided certain requirements are met, trading on behalf of a customer in a fiduciary capacity or in riskless principal trades and activities of an insurance company for its general or separate account. Provided certain requirements are met activities are other activities are not considered proprietary trading, including trading solely as an agent, broker, or custodian; through a deferred compensation or similar plan; to satisfy a debt previously contracted; under certain repurchase and securities lending agreements; for liquidity management in accordance with a documented liquidity plan; in connection with certain clearing activities; or to satisfy certain existing legal obligations.

The rule limits these exemptions if they involve a material conflict of interest; a material exposure to high-risk assets or trading strategies; or a threat to the safety and soundness of the banking entity or to U.S. financial stability.

Permitted proprietary trading activities may not result in a material conflict of interest between the bank and its customers, clients, or counterparties; lead to material exposure to high-risk assets or high-risk trading strategies; pose a threat to the safety of the bank; or pose a threat to the financial stability of the US.

Second, the Volcker Rule also provides strict restrictions on banks' **investments in hedge funds and private equity funds**. It prohibits any banking entity from:

- Owning more than 3% of any individual hedge fund or private equity fund;
- Investing more than 3% of its tier 1 capital in hedge funds and private equity funds in the aggregate;
- Engaging in any asset sale or lending transaction with a hedge fund or private equity fund it sponsors; or
- Bailing out a sponsored hedge fund or private equity in any way.

Similar to the proprietary trading prohibition no permitted investments may involve high-risk trading strategies or assets or a material conflict of interest with customers, clients, or counterparties.

The Volcker rule entails full ownership separation, thus the cease and divestment of the prohibited activities. Compared to existing US regulation, the Volcker Rule applies broadly at the consolidated level and restricts very specific types of activities that, although clearly financial in nature and in some cases very difficult to differentiate from permitted activities, were deemed by the US Congress to be incompatible as a policy matter with the appropriate risk profile and customer-driven mission of banking entities. It is therefore different from the regime in place under the Glass-Steagall Act between 1933 and 1999, which more bluntly separated commercial banking from investment banking and did not attempt to make fine distinctions between “high-risk” and “low-risk” activities, or “proprietary” and “customer-driven” activities, in regulating bank structure.

Concerning corporate governance, to hold bank chief executives accountable, they must attest in writing that their banks are setting up processes to maintain, enforce and review compliance programmes. The rule does not impose on bank executives however that they certify that the bank is not engaged in proprietary trading. The rules also grant a broader exemption for banks' market-making desks, on the condition that traders aren't paid in a way that rewards proprietary trading. Trading-desk compensation must not reward either proprietary trading or “excessive or imprudent risk-trading”.

These rules are likely to affect a relatively limited part of US banks' balance sheet. An in-depth examination by the US Government Accountability Office (GAO) of the proprietary trading activities of six largest US banks that carry out the bulk of trading overall highlighted that proprietary trading revenues were generally small compared to overall trading revenues and overall activities of these bank holding companies.⁸ The combined revenues between

⁸ US Government Accountability Office (2011), “*Proprietary trading: Regulators Will Need More Comprehensive Information to Fully Monitor Compliance with New Restrictions When Implemented*”, GAO-11-529.

2006 and 2010 from stand-alone proprietary trading⁹ represented between 1.4% - 12.4 of combined quarterly revenues for all trading, and between 0.2 – 3.1% of combined quarterly revenues for all activities at the bank holding companies. As regards revenues from hedge fund and private equity fund investments these were also small compared to overall revenues of the concerned bank holding companies, representing between 0.08% - 3.5% of the bank holding companies' combined revenues between 2006 and 2010.¹⁰

Given the attempt to make these distinctions but the difficulty of providing clear ex-ante definitions by means of legislation, the Volcker Rule relies on a **reporting and compliance regime** that will collect new data to be monitored over time and to a certain extent on supervisory judgment. The compliance requirements under the final rules vary based on the size of the banking entity and the scope of activities conducted. Banking entities with significant trading operations will be required to establish a detailed compliance program. Small banks, particularly US community banks, will have no compliance obligations under the final rule if they do not engage in any covered activities other than trading in certain government, agency, State or municipal obligations.

The proposed rulemaking was published for consultation in November 2011. The consultation closed in February 2012 and generated a substantial number of responses.¹¹ Key concerns raised by commenters during the consultation process included: (1) the appropriate scope of the exemption for market making-related activities, including concerns about (i) the impact on market liquidity if such exemption is not construed broadly and (ii) the potential for arbitrage and evasion if the exemption is not construed narrowly; (2) the scope and potential burden of compliance program and data reporting requirements included in the proposed rule; (3) the over breadth of the statutory definition of “hedge fund and private equity fund”; and (4) the extraterritorial implication of the Volcker Rule’s statutory application to (i) the non-U.S. activities of foreign banks and (ii) proprietary trading in non-U.S. sovereign debt by both U.S. and foreign banks.

US relevant regulatory agencies (Fed, FDIC, OCC, CFTC and SEC) have voted and adopted the final rules on 10 December 2013. The rules go into effect on April 1 2014, although the compliance date will be delayed for a year to July 21 2015. Starting in June 2014, large banks are required to begin reporting certain information.

In sum, in terms of the three dimensions highlighted at the outset, the Volcker rule’s provisions amounts to full ownership separation of proprietary trading and investments in certain funds and applies to all US financial groups containing insured depository institutions as well as to any foreign bank with a US branch or agency subject to certain exemptions.

⁹ The GAO concluded that banks have conducted proprietary trading at stand-alone proprietary trading desks and may have done it elsewhere in the firm, given the difficulty to delineate proprietary trading and market-making (e.g. traders may accumulate positions in a particular assets at levels that exceed the amount of the firm’s typical or necessary inventory in that asset used to facilitate customer trades). As US banks do not maintain records on proprietary trading done elsewhere, the GAO study focused on the activities of stand-alone desks only.

¹⁰ Ibid, p. 23.

¹¹ This included more than 18,400 ‘form letters’, i.e. letters signed by different associations or individuals that follow an identical template.

2.3. Swaps Push-out

Section 716 of the Dodd-Frank Act, known as the Swaps Push-out provision, states that if banks want to continue to benefit from federal assistance (deposit insurance and Federal Reserve discount window) they either have to stop engaging in certain swaps (certain credit derivatives, all equity and most commodity derivatives) or do such swaps in a separate legal entity, registered as a swap dealer and subject to capital requirements and margin requirements under the derivatives sections of the Act. The provision would not affect those derivatives judged to be important for banks' management of risks (i.e. interest rate, foreign exchange, gold/silver, credit derivatives where underlying is an investment-grade security), which could thus continue to be provided within the bank. The concerned derivatives are likely to be a fraction of the overall derivatives business of major US banks.¹²

The large US banks that dominate US derivatives activity already have separately capitalised affiliates that could house the pushed-out derivatives. Moreover, the additional capital required is likely to be incremental. The main cost of the provision appear to be for clients that could lose the benefits related to cross-derivative product netting and who would have to deal with one more counterparty (the separately capitalised affiliate).

This provision is scheduled to enter into effect in July 2013. However, insured depository institutions can apply for a two-year extension, with a further one-year extension available afterwards. Furthermore, the US Congress is debating potential changes to Section 716, which would significantly broaden the range of permissible derivatives.¹³

2.4. On-going discussions on further structural measures

US policymakers continue to discuss potential additional structural measures to address banks that are too-big-to-fail. These discussions are primarily driven by some members of Congress and some supervisors. While these bills are at an early stage of debate and do not necessarily muster sufficient political support, they are indicative of an ongoing US debate on structural measures as regards TBTF banks. Different alternatives arise in these discussions. One draft legislative bill has proposed to significantly increase capital standards of the largest banks at both consolidated level and the level of individual subsidiaries; introduce stricter firewalls between these subsidiaries; and, would prohibit non-depository institutions having access to the safety net.¹⁴ Another draft has instead proposed to introduce absolute size limits¹⁵,

¹² According to Fitch Ratings, the total notional value of derivatives for the four commercial banks that would be most affected – JPMorgan Chase, Bank of America, Citigroup and Wells Fargo – was USD193bn at the end of 2011. Of these 95% would be permissible derivatives and hence would not need to be pushed out.

¹³ H.R. 992, the Swaps Regulatory Improvement Act, as introduced by a bipartisan set of members of the House of Representatives. If enacted, it would effectively only push out those 'structured finance swaps', i.e. a swap or security-based swap based on an asset-backed security, that are not of credit quality and that are not used for hedging or risk management purposes.

¹⁴ S. 798, TBTF Act, introduced by Senators Brown (D) and Vitter (R) on 24 April 2013.

¹⁵ H.R. 5714, SAFE Banking Act of 2012, introduced by Congressman Miller (D) and Sherman (D) on 10 May 2012.

whereas a third draft bill¹⁶ would effectively reinstate the prohibition on ownership affiliations between commercial banks and securities broker/dealers of the Glass-Steagall Act.

3. UNITED KINGDOM

In June 2010, the UK government set up an Independent Commission on Banking (ICB) with the task of assessing bank structural reform. In September 2011, the ICB recommended that large UK banks should ring-fence their retail bank operations into separate legal subsidiaries subject to their own prudential safeguards. It also recommended that such groups should increase their loss absorbing capacity both at group level and at the level of the ring-fenced retail entity. The UK government has put forward draft primary legislation aimed at implementing the ICB's recommendations, aimed at enabling pre-legislative scrutiny by a Parliamentary Commission on Banking Standards (PCBS), set up in October 2012 as part of a broader exercise aimed at assessing the UK banking sector.¹⁷ The PCBS made a number of suggestions for amending the legislative proposal, some of which were taken up by the UK Government in the bill finally submitted to the Parliament in February 2013.¹⁸ Secondary legislation is forthcoming and the government has indicated that all legislation will be in place by May 2015. The framework is scheduled to enter into force by the start of 2019.

3.1. Activities to be separated

The ICB divided activities into 'mandated', 'prohibited' and 'ancillary' services. The UK draft bill distinguishes between core activities (and related services) and excluded activities. More specifically:

- **Mandated services / core activities:** mandated services are services where even temporary interruption has significant economic costs and where customers are not well equipped to plan for such interruption. The ICB defined such services as taking of deposits from and providing overdrafts to individuals and SMEs. These services would have to be separated and could only be provided by the ring-fenced retail bank. The bill takes this on board, specifying accepting deposits as a 'core activity' and outlining three 'core services' that only ring-fenced banks can provide (including withdrawal/payments and overdraft). The bill also grants the Treasury the ability to include additional activities as well as exempt certain activities and services subject to certain conditions. The government has indicated that it will use the exemption possibility in secondary legislation to exempt high-net worth individuals and large corporate entities from the ring-fence obligation.
- **Prohibited services / excluded activities:** some services cannot be provided by the ring-fenced entity. The ICB stated that those are services that (i) make it harder/more

¹⁶ S. 1282, A bill to reduce risks to the financial system by limiting banks' ability to engage in certain risky activities and limiting conflicts of interest, to reinstate certain Glass-Steagall Act protections that were repealed by the Gramm-Leach-Bliley Act, and for other purposes, introduced by Senators Warren (D), McCain (R), and others on 11 July 2013.

¹⁷ HM Treasury (2012), Sound banking: delivering reform, October 2012.

¹⁸ Financial Services (Banking Reform) Bill, No. 130, 4 February 2013. An overview of the UK legislative process, including proposed amendments, can be found on the Parliament's website: <http://services.parliament.uk/bills/2013-14/financialservicesbankingreform.html>

costly to resolve ring-fenced bank, (ii) increase exposure to global financial markets, (iii) involve risk taking and are not integral to provision of payments services to customers or direct intermediation of funds between savers and borrowers within non-financial sector, and (iv) services that threaten the objectives of the ring-fence. The ICB did not exhaustively define those services, but highlighted that it would include (i) services provided to customers outside EEA, (ii) services that result in exposure to non-ring-fenced bank or non-bank financial organisation (except payment services), (iii) services that result in trading book asset, (iv) services that result in having to hold regulatory capital against market risk, (v) purchase/origination of derivatives /other contracts resulting in having to hold regulatory capital against counterparty credit risk, and (vi) secondary markets activity including purchase of loans/securities. The government bill states that dealing in investments as principal is an excluded activity. Similar to core activities, it grants Treasury the power to rule other activities as excluded, as well as a power to provide for exceptions to the ban on dealing in investments as principal.

This has an impact on **derivatives**. The ICB recommended that ring-fenced banks would only be able to act as agents for derivative products sold by others, not as principal. In its response to the ICB, the government argued that ring-fenced banks should be able to sell *simple* derivatives subject to certain conditions (e.g. only certain types, to certain customers, centrally managed risks, and subject to certain limits). The government has indicated that those conditions will be set in secondary legislation. Meanwhile, the PCBS has concurred with the government in that there might be a case for permitting ring-fenced banks to sell simple derivatives but has proposed additional conditions: (i) safeguards to prevent mis-selling, (ii) a limited and durable definition in legislation of ‘simple derivatives’, and (iii) that there would be an additional cap on the gross volume of derivative sales for ring-fenced banks, and on the total value of derivatives used for hedging. It also called on the regulator to report annually on ring-fenced banks’ sale of derivatives. The government has committed to incorporate the PCBS’ suggestions into secondary legislation.

- **Ancillary services:** activities that are necessary for the efficient provision of mandated services may be provided by the ring-fenced bank. This concept has not been reflected in legislation so far.

Possible conditions governing ring-fenced banks’ dealing in derivatives as principal

In allowing ring-fenced banks to sell derivatives, a number of safeguards have been considered to ensure that this activity does not expose the ring-fenced banks to additional risks and/or make it more difficult to resolve. The safeguards are aimed at restricting the sale of derivatives to more simple ones and to limit the economic importance of this potential business.

The **government**¹⁹ has previously outlined that simple derivatives would only mean certain *types* of derivative contracts (standardised interest rate and foreign exchange derivatives) and could only be sold to certain customers (only to holders of mandated deposits, i.e. households and SMEs, and non-financial institutions). It has also considered conditioning the sale of derivatives on their risk management characteristics. Along that line, the ring-fenced bank should show that it can manage counterparty and market risk and that the portfolio can be unwound or transferred if the bank fails. Accordingly, ring-fenced banks could be able to hedge its net

¹⁹ UK Government – White Paper on banking reform, June 2012.

market risk if it used standardised derivatives on arm's length/third party basis. Hedging derivatives could also be permitted if they were centrally cleared on a CCP or bilaterally cleared with daily margin calls and exchange of collateral. However, residual market exposures should be capped at a low percentage of the ring-fenced bank's Tier 1 capital, and netting arrangements should respect ring-fenced banks' independence.

The **PCBS**²⁰ has proposed three additional safeguards: (i) prevent mis-selling, (ii) a limited and durable definition in legislation of 'simple derivatives', and (iii) an additional cap on the gross volume of derivative sales for ring-fenced banks, and on the total value of derivatives used for hedging.

According to UK government and ICB estimates, this separation would lead to a relatively narrow deposit bank and a broad trading entity. It would retain 18%-36% of the UK total banking assets in the deposit-taking ring-fenced retail bank and would shift the remaining 64%-82% to the other legal entity that does trading and is not allowed to take insured deposits.²¹

3.2. Strength of separation

As regards the strength of the separation, the ICB put forward recommendations related to (i) the legal and operational links, and (ii) economic links of ring-fenced banks that are part of a wider group.

As regards **legal and operational links**, the ICB recommended that ring-fenced part should be possible to isolate from group in some days and able to continue provide services without solvency support. For that to be the case, the following conditions should be met. First, the ring-fenced bank should be a separate legal entity. Second, if the ring-fenced bank owns other organisations, these should only do activities permitted within retail ring-fence. Third, the wider corporate group should ensure that ring-fenced bank has access to all services it needs to continue its operations irrespective of the state of wider group. Finally, the ring-fenced bank should be direct member of payment systems, or use another ring-fenced bank as agent.

As regards **economic links**, the ICB stated that ring-fenced bank's relations with other parts of group should take place on a third party basis. Ring-fenced bank should not be dependent on group's continued financial health for its solvency or liquidity. Accordingly, relationships with other group entities should for regulatory purposes be treated similar to relations with third parties. Second, transactions with other group entities should be conducted on commercial and arm's length basis. Third, assets sold to other group entities should be at market value. Fourth, ring-fenced bank should meet regulatory requirements, including for capital, large exposures, liquidity and funding on a solo basis. Fifth, ring-fenced bank should only distribute dividends/transfer capital if its board believes it has resources to do so. If this leads it to breach capital requirements, they would need explicit regulatory approval. Sixth, the board of ring-fenced bank should be independent. Furthermore, ring-fenced bank make regulatory disclosures on a solo basis and, finally, the board of ring-fenced bank and board of parent company have duty to maintain integrity of ring-fence.

The **government** has accepted these recommendations. The proposed primary legislation has structured the rules that ring-fenced banks have to respect to ensure their legal, operational

²⁰ UK Parliamentary Commission on Banking Standards, First and Second Report, December 2012 and February 2013.

²¹ Independent Commission on Banking (2011), *Final report: recommendation*, September 2011, p. 53.

and economic independence vis-à-vis the wider group along five dimensions highlighted during PCBS hearings by Andy Haldane of the Bank of England and Sir John Vickers:

- Separate governance;
- Separate risk management;
- Separate balance sheet (treasury) management;
- Separate remuneration structure and human resourcing; and
- Independence of capital and liquidity.

In addition, debate continues on additional measures to strengthen the separation. First, the PCBS debate has highlighted a concern with the durability of the ring-fence in light of regulatory arbitrage eroding it over time. To counter that risk, the PCBS has proposed granting additional reserve powers to ‘**electrify**’ the **ring-fence** if banks do not comply, i.e. to force full ownership separation. This, it is argued, would discourage banks from testing the limits of the ring-fence. A first reserve power would empower regulators to, subject to conditions force *a specific banking group* to divest itself fully of either its ring-fenced bank or its non-ring-fenced bank. In addition, the PCBS argues that the ring-fence framework should be subject to regular independent review, which should assess whether ring-fencing is achieving its objectives and, as a second reserve power, assess whether there is a case for a move to full ownership separation across the banking sector as a whole.²² Whereas the government has agreed to amend the bill to reflect the first reserve power it has not accepted the independent review or the second reserve power. The PCBS has accordingly suggested amendments to the bill.²³

Second, as regards **group corporate structures**, apart from stating that ring-fenced banks could not own entities that provide prohibited services, the ICB was not prescriptive about groups with ring-fenced banks should be structured. It notably did not suggest prohibiting non-ring-fenced banks from owning ring-fenced banks. The case has since been made that the bill should include a power to prohibit such ‘parent-child’ ownership structures on the grounds that it would undermine the strength of the ring-fence and notably the provision that relations should be on an arm’s length basis. A parent-subsidiary structure based on control would contradict this principle. A ‘sibling’ ownership structure, where the ring-fenced and non-ring-fenced banks are subsidiaries of a holding company, would facilitate the objectives of the ring-fence. The PCBS have accordingly called for the bill to be amended so as to require concerned banking groups to organise themselves as sibling structures with holding companies on top.²⁴ The government has rejected this call, arguing that the first reserve power combined with additional powers being considered as part of the EU Bank Resolution and Recovery Directive would grant sufficient powers to regulators to intervene in group structures to this end. The PCBS has accordingly put forward an amendment requiring that

²² PCBS (2012), First report, p. 69 onwards.

²³ PCBS (2013), Second report, p. 5-12.

²⁴ PCBS (2012), First report, p. 95.

shares in a ring-fenced body are held only by another member of the group that is not carrying on an excluded activity.²⁵

3.3. Institutions to be covered by separation requirement

The ICB recommended that the ring-fence obligations would apply to all UK domiciled banking groups. The bill excludes building societies from ring-fencing.²⁶ The bill also grants the Treasury power to exclude other institutions from the ring-fencing obligation. The government has indicated that it would use this power to exempt smaller institutions from the ring-fencing requirement by means of a de minimis exemption whereby which banks with less than £25bn in mandated deposits would not have to implement the ring-fence.

3.4. Loss absorbency

As regards **loss absorbency**, the Government endorses the ICB's recommendations on loss absorbency. Ring-fenced banks should accordingly hold a minimum level of 17% of primary loss absorbing capacity (PLAC) consisting of an equity buffer of 3% and a choice for banks whether to hold the remaining 7 percentage points in either equity or highest quality loss absorbing debt. For non-ring-fenced banks, the Government proposes that the most systemic UK G-SIBs (those subject to 2.5% G-SIB surcharge) should hold at least 17% PLAC against all domestic and non-exempted overseas operations.²⁷ The ICB proposed to scale these requirements in line with an institution's size; the Government proposes to await conclusion of international negotiations on D-SIBs before making a decision on how to scale.

The government furthermore takes up the ICB's suggestion to change the creditor hierarchy so that insured deposits (those covered by the UK deposit guarantee system – FSCS) are preferred in insolvency, i.e. depositors rank ahead of other creditors (**depositor preference**). The aim is to sharpen the incentives for other senior unsecured creditors to exert discipline on banks' behaviour.

Contrary to the ICB, the government does not propose to require larger ring-fenced banks to respect stricter **leverage limits** than those considered internationally. Accordingly, it endorses the 3% limit currently contained in Basel III. This is being contested by the PCBS that instead endorses stricter and more immediately applicable leverage limits.²⁸

The government supports **bail-in** and expects to implement it when transposing the European Commission's proposal for a Recovery and Resolution Directive (RRD) that contains bail-in

²⁵ PCBS (2013), Second report, p. 20, as well as Amendment R, p. 65.

²⁶ However, the 1986 Building Societies Act already restricts the activities building societies can provide and the government has indicated that a forthcoming review will further bring the Act in line with the ring-fencing requirement.

²⁷ In December 2011 the UK Government indicated that it would consider exempting non-EEA operations from the PLAC requirement if banks could show that those operations posed no risk to the EEA. It subsequently reversed the burden of proof, with such exposures being automatically exempt unless authorities can show that they pose a risk. This has been contested by the PCBS, arguing that banks should carry the burden of proof. This has in principle been accepted by the government and will be reflected in secondary legislation.

²⁸ PCBS (2013), Second report, p. 28.

powers, and not earlier as requested by the PCBS. PLAC should accordingly consist of capital (equity, Additional Tier 1 and Tier 2) and long-term unsecured debt that is subject to the bail-in power.

4. FRANCE

The French government in December 2012 put forward a proposal for a law separating and regulating banking activities.²⁹ The proposal has since been approved with modifications by the *Assemblée nationale* and the *Sénat*.³⁰ Both assemblies will now be working towards a common version. The law would amend the legislative section of the Monetary and Financial Code. Subsequent changes to the regulatory section are likely to follow to further spell out the exact provisions.

4.1. Activities to be separated

The French draft reform proposes that French banking groups with trading activities above a certain limit (to be defined by administrative provisions) would only be allowed to engage in (i) certain own-account dealings – hereinafter 'proprietary trading' –d and (ii) in certain dealings with leveraged funds by means of ring-fenced subsidiaries that are not funded by insured deposits.

As regards the provision separating proprietary trading, it is stated that French banking groups would still be allowed to engage in certain own-account activities that are deemed useful for the real economy, subject to certain conditions:

- Provision of **investment services (notably risk hedging) to clients**. In order to determine that these activities are client oriented, the services in question should be remunerated by the client and the risks should be prudently managed;
- **Risk hedging for the credit institution or group**, i.e. with the aim of reducing risk exposures related to credit and market risks, where the hedges must present an economic link with the identified risk (to be defined by administrative provisions);
- **The clearing** of financial instruments;
- **Market-making**, i.e. either the simultaneous publication of firm and competitive two-way quotes for comparable volumes with the result of providing liquidity to the market, or involving as part of its usual activity the execution of buy and sell orders on behalf of clients. The draft law proposes a set of indicators that would need to be monitored so as to determine that the market-making activity is not concealed proprietary trading. The draft law would also grant the power to the Minister of the

²⁹ « *Projet de loi de séparation et de régulation des activités bancaire* », 19 December 2012.

³⁰ Information about the debate and amendments can be found on the website of the *Assemblée nationale*: http://www.assemblee-nationale.fr/14/dossiers/separation_regulation_activites_bancaires.asp

Economy to set a threshold above which banks would no longer benefit from the exemption³¹;

- **Prudent group treasury management**, subject to forthcoming conditions (the forthcoming conditions related to prudent management have been added to avoid JP Morgan CIO style events); and
- **Group investment operations**, i.e. long-term investments.

In addition, any ownership interests or unsecured exposures towards certain **leveraged funds** (e.g. hedge funds) would also have to be transferred to the investment entity.

The French government impact analysis did not publish any figures for the proportion of assets that would be affected by the separation requirement.³² This was due to the limited number of banks³³ concerned and the associated confidentiality problems. The analysis did neither disclose an average number, as the extent of proprietary trading vary substantially between the banks in question. However, external analyses suggest that proprietary trading constitute a very limited proportion of bank assets.³⁴ This has prompted analysts to conclude that this reform would have a moderate impact on the French universal banking model.³⁵

4.2. Strength of separation

The segregated entities would be authorised as investment firms or, by derogation, as credit institutions. These would have to respect the following conditions:

³¹ Note that following discussions in the Assemblée nationale, the draft law features three new paragraphs on this distinction:

*« L'Autorité de contrôle prudentiel et de résolution contrôle que la distinction de l'activité de tenue de marché, mentionnée aux 1° et 2°, par rapport aux autres activités est bien établie en se fondant, pour les activités mentionnées au 1°, notamment sur des **indicateurs précisant les conditions de présence régulière sur le marché, l'activité minimale sur le marché, les exigences en termes d'écart de cotation proposés et les règles d'organisation internes incluant des limites de risques**. Les indicateurs sont adaptés en fonction du type d'instrument financier négocié et des lieux de négociation sur lesquels s'effectue l'activité de tenue de marché. Le teneur de marché fournit sur base régulière les indicateurs à l'Autorité de contrôle prudentiel et de résolution et à l'Autorité des marchés financiers.*

« Pour les activités visées au 2°, l'établissement doit pouvoir justifier d'un lien entre le besoin des clients et les opérations réalisées pour compte propre. L'Autorité de contrôle prudentiel et de résolution apprécie cette activité au regard notamment de la fréquence des opérations réalisées.

« Un arrêté du ministre de l'économie, après avis de l'Autorité des marchés financiers et de l'Autorité de contrôle prudentiel et de résolution, fixe la liste des indicateurs visés au I du présent article. »

³² Ministère de l'Économie et des Finances (2012), *Projet de loi de séparation et de régulation des activités bancaires : Étude d'Impact*, p. 17.

³³ See footnote 29.

³⁴ For example, BNP Paribas is estimated to have less than 2 % of its corporate- and investment-banking revenues affected by the government plans. See Chevreux Daily B.A.N.K. Keynote on bank reform, 3 December 2012.

³⁵ See e.g. BofA Merrill Lynch Global Research (2012), "French banks: French bank regulatory reform evolutionary not revolutionary", December 2012.

- They would be barred from taking guaranteed deposits and from providing payment services to clients with guaranteed deposits;
- They would have to respect prudential requirements on an individual or sub-consolidated basis. The banking group controlling these entities would furthermore have to deduct the exposures to these entities when calculating their own fund requirements;
- As regards large exposures, the segregated entity is regarded as being part of the group; and
- The segregated entity should have a separate commercial identity (e.g. name) so as to avoid confusion;
- The segregated entity should have separate corporate governance, in the sense that the persons that determine its business focus cannot be the same ones as the wider group;
- Finally, the segregated entities would be prohibited from carrying out (a) at high frequency trading and (b) trading in agricultural commodity derivatives.

The law also foresees a strengthening of the supervision of market activity, as well as granting the supervisor (ACPR) extended powers to ban banks from engaging in specific activities or providing certain products.

4.3. Institutions to be covered by separation requirement

The scope of the proposed reform is limited to banking groups (credit institutions, financial holding companies, and mixed financial holding companies) with significant trading activities, measured as a share of their total assets. The threshold for such a *de minimis* exemption will be defined by decree.³⁶

5. GERMANY

In February 2013, the German government put forward a draft bank-separation law and new criminal-law provisions for the financial sector.³⁷ The draft law was modified in the parliamentary procedure.³⁸ The law, which was promulgated in the Federal Law Gazette (*Bundesgesetzblatt*) on 12 August 2013³⁹, amends in particular the German Banking Act. The

³⁶ The impact assessment accompanying the proposal indicates that the threshold will be set so as to capture the largest French banks. Accordingly four banks (BNPP, SG, CA, BPCE) with trading activities ranging from 20-40% of total assets are likely to be subject to the requirements.

³⁷ *Entwurf eines Gesetzes zur Abschirmung von Risiken und zur Planung der Sanierung und Abwicklung von Kreditinstituten und Finanzgruppen*, 6 February 2013. The draft law can be found on the website of the Parliamentary Material Information System <http://dipbt.bundestag.de/dip21/brd/2013/0094-13.pdf>.

³⁸ Information about the debate and amendments can be found on the website of the Parliamentary Material Information System <http://dipbt.bundestag.de/extrakt/ba/WP17/508/50871.html>.

³⁹ *Gesetz zur Abschirmung von Risiken und zur Planung der Sanierung und Abwicklung von Kreditinstituten und Finanzgruppen* of 7 August 2013 (BGBl. I, page 3090).

provisions dealing with separation of activities (Article 2 of the law) are similar to the French approach, with some differences as regards the activities to be separated and strength of separation. The law also contains a fleshed-out *de minimis* exemption. Article 2 of the law will enter into force on 31 January 2014.

5.1. Activities to be separated

In terms of **activities**, it prohibits banks and enterprises belonging to the same group as a bank from engaging in (i) proprietary business, (ii) lending and guarantee business with hedge funds and European or foreign alternative investment funds (AIFs), and (iii) proprietary trading with the exception of market-making unless that activity is conducted in a separate financial trading institution (FTI). An FTI would not be allowed to provide payment services or e-money services.

However, business that is (i) aimed at hedging transactions with clients (except from AIFs) or that serve the institution's or its alliance's⁴⁰ interest rate, currency, liquidity or credit risk management, (ii) that involves the purchase or sale of long-term holdings or business which does not serve the purpose of drawing profit from the short-term use of existing or expected differences between the purchase and sale prices or volatilities of prices or interest rates, would not be prohibited.

Irrespective of the *de minimis* exemption, the supervisor *BaFin* will be able to prohibit a bank or an enterprise belonging to the same group as a bank to carry on certain activities (market-making activities, activities that when exceeding the thresholds are prohibited by law or activities that are comparable in terms of risk to the these activities) and ask it either to cease these activities or to transfer them to an FTI if there is a concern that this business threatens to jeopardise the solvency of the bank or the enterprise belonging to the same group as a bank due to the volume, profit or risk structure of the activity.

The explanatory notes accompanying the German proposal did not publish any figures for the proportion of assets that would be affected by the separation requirement. This may be due to similar confidentiality problems. Similar to French banks, proprietary trading is likely to constitute a very limited proportion of German banks' assets.

5.2. Strength of separation

The business to be separated would be operated at a commercially, organisationally and legally separate enterprise (i.e. FTI).

The FTI would have to secure its own refinancing independently. Dealings between the banking group and its other entities with the financial trading institution should be dealt on a third party basis.

In terms of governance, BaFin will be able to issue orders to ensure appropriate business organisation in terms of separation.

Specific reporting obligations for the bank and the superordinated enterprise of a group encompassing a bank towards the *BaFin* may be imposed by secondary legislation. The supervisory boards of the FTI, the bank and the superordinated enterprise are obliged to

⁴⁰ I.e. the networks of credit cooperatives and savings banks.

inform themselves regularly and as required on the activities of the FTI, the risks involved and compliance with requirements.

5.3. Institutions to be covered by separation requirement

The law sets a *de minimis* exemption regarding the statutory prohibition of activities for banks and groups comprising a bank which either have (i) assets held for trading and available for sale under €100bn, or (ii) have total assets of less than €90bn, subject to the above-mentioned trading assets not constituting more than 20% of total assets. This exemption does, however, not apply for the power of the *BaFin* to prohibit activities and ask for their cessation or transfer.

The statutory prohibition of activities will apply as of 1 July 2015. However, the relevant business is only prohibited and has to be ceased or transferred to an FTI twelve months after exceeding one of the thresholds. The *BaFin's* power to prohibit activities and ask for their cessation or transfer will apply as of 1 July 2016.

6. HIGH-LEVEL EXPERT GROUP ON REFORMING THE STRUCTURE OF THE EU BANKING SECTOR (LIIKANEN)

The High-level Expert Group on reforming the structure of the EU banking sector, chaired by Erkki Liikanen, delivered its report in October 2012. It notably recommended the mandatory separation of certain high-risk trading activities into a separate legal entity.

6.1. Activities to be separated

The Group concluded that it is necessary to require the legal separation of certain particularly risky financial activities from deposit-taking banks within the banking group. The Group therefore recommended that the following activities would need to be assigned to a separate legal entity (“trading entity”):

- Proprietary trading;
- All assets or derivative positions incurred in the process of market-making, other than the activities exempted below; and
- Any loans, loan commitments or unsecured credit exposures to hedge funds (including prime brokerage for hedge funds), SIVs and other such entities of comparable nature, as well as private equity investments.

The group argued that these activities naturally belong to each other and accordingly should be conducted within the same entity.

The following activities would be exempted from the separation requirement:

- Hedging services to non-banking clients (e.g. using forex and interest rate options and swaps) which fall within narrow position risk limits in relation to own funds, to be defined in regulation;
- Securities underwriting;

- Use of derivatives for own asset and liability management purposes; and
- Sales and purchases of assets to manage the assets in the liquidity portfolio.

Only the deposit bank would be allowed to supply retail payment services. All other banking business would be permitted to remain in the entity which uses insured deposits as a source of funding (“deposit bank”), unless firm-specific recovery and resolution plans require otherwise.⁴¹

The Group furthermore recommended that authorities should be able to require a bank to separate a wider set of trading activities, if the recovery and resolution planning highlighted that this activity involved (i) particularly complex trading instruments, (ii) particularly complex governance and legal structures, and (iii) led to risk positions that were large in relation to overall market size for the particular instrument.

6.2. Strength of separation

In terms of strength of separation, the Group put forward the following recommendations:

- **Separate capitalisation:** Both the deposit bank and the trading entity would each individually be subject to all the regulatory requirements (e.g. CRR/CRDIV and consolidated supervision) which pertain to EU financial institutions. They would accordingly need to be separately capitalized according to the respective capital adequacy rules, including the maintenance of the required capital buffers and possible additional Pillar 2 capital requirements. In addition, the trading entity and deposit bank only pay dividends if respect capital requirements;
- **Limits on intra-group transfers:** intra-group transfers would need to be on market-based terms and should be restricted according to normal large exposure rules. Direct or indirect transfers would furthermore not be allowed to the extent that capital adequacy, including additional capital buffer requirements on top of the minimum capital requirements, would be endangered; and
- **Corporate structure:** The requirements would apply on the consolidated level and the level of subsidiaries. The Group furthermore stated that the legally-separate deposit bank and trading entity could operate within a bank holding company structure. At any rate, the deposit bank would need to be sufficiently insulated from the risks of the trading entity.

6.3. Institutions to be covered by separation requirement

Structural separation would only be mandatory if the activities to be separated amount to a significant share of a bank’s business, or if the volume of these activities can be considered significant from the viewpoint of financial stability. Accordingly, the smallest banks would be

⁴¹ According to the HLEG, these permitted activities would “include, but need not be limited to, lending to large as well as small and medium-sized companies; trade finance; consumer lending; mortgage lending; interbank lending; participation in loan syndications; plain vanilla securitisation for funding purposes; private wealth management and asset management; and, exposures to regulated money market (UCITS) funds.”

considered to be fully excluded from the separation requirement. The Group suggested that the decision to require mandatory separation should proceed in two stages:

- **Examination thresholds:** In the first stage, if a bank's assets held for trading and available for sale exceed (1) a relative examination threshold of 15-25% of the bank's total assets or (2) an absolute examination threshold of EUR100bn, the banks would advance to the second stage examination.
- **Separation threshold:** In the second stage, supervisors would determine the need for separation based on the share of assets to which the separation requirement would apply (i.e. proprietary trading, market-making, and loans and unsecured exposures to certain funds). This threshold, as share of a bank's total assets, would need to be calibrated by the Commission. Mandatory separation would apply to all banks for which the activities to be separated are significant, as compared to the total balance sheet.

Once a bank exceeds the final threshold, all the activity concerned should be transferred to the legally-separate trading entity.

6.4. Other

The Group furthermore made a number of recommendations in other areas.

It recommended possible amendments to the use of **bail-in instruments** as a resolution tool, notably that the bail-in requirement would be used explicitly only to a certain category of clearly defined debt instruments and that the bail-in instruments would not be held within the banking sector.

It called for a **review of capital requirements on trading assets and real estate related loans**, once on-going international reviews finalised, and at a general level called for strong and coordinated actions to improve the consistency of internal models across banks. Furthermore, to strengthen the macro-prudential framework, it called on Member States to include caps on loan-to-income and loan-to-deposits in their macro-prudential toolboxes; and

It recommended measures aimed at **strengthening the governance and control of banks**, including e.g. fit and proper tests to ensure management ability to run large and complex banks; measures related to remuneration, and more detailed risk disclosure at legal entity level so as to strengthen scrutiny and market discipline.

7. CONCLUSION

From the above, whereas the different proposals share the ambition of better protecting retail deposits, they differ as regards (i) the activities they formally suggest separating, (ii) the strength of separation considered, and (iii) the scope of institutions they are intended to apply to. The proposals are summarised in the table below.

Table 1 – Overview of structural reform measures in place or being proposed

	Measure	Type of separation	Activities	Strength	Institutions	Other
US	Bank Holding Company Act (BHC)	Functional separation	<ul style="list-style-type: none"> BHC cannot engage in activities of commercial nature; Insured depository institution can only engage in core banking activities (e.g. taking deposits, lending) and incidental activities (e.g. custody and asset management) 	<ul style="list-style-type: none"> Quantitative limits on certain transactions between a BHC and its affiliates (FRA Section 23A); Transactions between BHC and affiliates to be on market-based terms (FRA Section 23B). 	BHC	
	Prohibition on proprietary trading and investments in certain funds	Ownership separation	<ul style="list-style-type: none"> Proprietary trading, except permitted activities: <ul style="list-style-type: none"> Underwriting and market-making; Risk-mitigating hedging activities; Trading in US government securities ... PE/hedge fund investments, unless (de minimis): <ul style="list-style-type: none"> Less than 3% of individual fund; Less than 3% of bank's Tier1 capital in aggregate. <p>Permitted /de minimis activities may not lead to:</p> <ul style="list-style-type: none"> Material exposure to high-risk trading strategies or assets; Material conflict of interest with customers & counterparts; Threat to safety of bank; or Threat to US financial stability. 	Prohibition Prohibition with de minimis exemption	Any US depository institution; Any firm affiliated with a US depository institution; and Any foreign bank with a US branch or agency	Reporting and compliance regime adapted to magnitude of banks' trading activity.
	Ring-fencing of certain derivatives ("Swaps Push-out")	Functional separation	<p>Banks benefiting from federal assistance cannot engage in certain swaps (certain credit derivatives, all equity and most commodity derivatives).</p> <p>If they do, such swaps must be transferred to a separate legal entity, registered as a swap dealer and subject to capital requirements and margin requirements</p>		Any US depository institution; Any firm affiliated with a US depository institution; and Any foreign bank with a US branch or agency	

			under the derivatives sections of the Dodd-Frank Act. Swap entities do not have access to federal assistance.			
UK	Ring-fencing of retail banking activities	Functional separation	<ul style="list-style-type: none"> Core activities (deposit taking) Core services (incl. withdrawal, payments and overdraft) 	<p><i>Legal separation</i></p> <ul style="list-style-type: none"> Separate legal entity ring-fenced from group; If RFB owns other organisations, those only do activities permitted to RFB; <p><i>Separate governance</i></p> <ul style="list-style-type: none"> RFB independent board; RFB separate disclosure; Boards RFB and NRFB have duty to uphold ring-fence. <p><i>Operational links</i></p> <ul style="list-style-type: none"> Operational independence irrespective of state wider group; RFB member of payment systems; Separate remuneration structure and human resourcing; <p><i>Economic links</i></p> <ul style="list-style-type: none"> Relations between RFB and non-RFB on third party basis; Transactions RFB-NRFB on commercial, arm's length basis; Assets sold at market value Independence of capital and liquidity. Separate risk management Separate balance sheet (treasury) management; Dividends/transfer of capital only if board believes sound; 	All UK incorporated banks subject to exemptions: <ul style="list-style-type: none"> Not building societies; Not banks below certain size (Secondary legislation, indication GBP25bn) 	<p>Additional loss absorbercy (equity, debt):</p> <ul style="list-style-type: none"> Ring-fenced bank: primary loss absorbing capacity (PLAC) of 17% RWA (equity buffer 3%, remainder either equity or loss absorbing debt); Non-ring-fenced bank: at least 17% PLAC against all domestic and non-exempt overseas operations. <p>Annual review of ring-fence effectiveness by PRA</p> <p>Reserve powers (electrification of fence) to regulators to require ownership separation from specific banks if attempt to circumvent.</p>
FR	Ring-fencing of certain trading activities	Functional separation	<ol style="list-style-type: none"> Proprietary trading Unsecured lending for own account to leveraged entities 	<p><i>Legal separation</i></p> <ul style="list-style-type: none"> Separate legal entity ring-fenced from group <p><i>Economic links</i></p> <ul style="list-style-type: none"> Independence of capital and liquidity TE not take guaranteed deposits TE not provide 	De minimis exemption for banks with trading activity below a certain threshold (secondary legislation)	

				<ul style="list-style-type: none"> – retail payment services – Tighter intra-group large exposure limits <p><i>Separate governance</i></p> <ul style="list-style-type: none"> – Different commercial identity; – Different leadership 		
	Prohibition of certain trading strategies and trading in certain instruments	Ownership separation	Segregated entity cannot engage in following activities: <ul style="list-style-type: none"> – High frequency trading – Trading in agricultural commodity derivatives 			
DE		Functional separation (ring-fencing of certain trading activities)	<ol style="list-style-type: none"> 1. Proprietary business; 2. Lending and guarantee business with hedge funds and AIFs; 3. Proprietary trading with the exception of market-making 	<ul style="list-style-type: none"> – Commercial separation; – Legal separation; – Organisational separation; – Own refinancing of financial trading institution (FTI) to be secured independently; – Group transactions on third party basis; – Reporting obligations towards the <i>BaFin</i> (secondary legislation) 	<p>Banks and enterprises belonging to the same group as a bank.</p> <p>De minimis exemption for entities with trading assets (HFT+AFS) that are:</p> <ul style="list-style-type: none"> – below €100bn; or – below 20% of total assets if total assets are below 90bn. 	
HLEG		Functional separation (ring-fencing of certain trading activities)	<ol style="list-style-type: none"> 1. Proprietary trading; 2. Market-making; and 3. Loans/unsecured exposures related to hedge funds etc. 	<ul style="list-style-type: none"> – Separate legal entity – trading entity (TE) – Can operate within holding company structure; DB must be sufficiently protected from TE risk. – RRP to ensure operational continuity of IT/payment system infrastructures in crisis. – Independence of capital and liquidity – Intra-group transfers on market-based terms – Intra-group transfers according to normal large exposure rules – Dividends and direct/indirect intra-group transfers only possible if still respect capital requirements (incl. 	<p>De minimis exemption, as only apply to banks with significant trading activity:</p> <ul style="list-style-type: none"> – Examination thresholds: Relative threshold of 15-25% of the bank's total assets; absolute threshold of EUR100bn; – Separation threshold: supervisors determine need for separation based on share of assets to which the separation requirement would apply. Threshold, to be calibrated 	

				buffers) – TE not take guaranteed deposits – TE not provide retail payment services	by the Commission.	
--	--	--	--	---	--------------------	--

ANNEX A2 – SUMMARY OF REPLIES TO THE STAKEHOLDER CONSULTATION ON STRUCTURAL REFORM OF THE BANKING SECTOR

In the context of the impact assessment accompanying a potential legislative proposal on reforming the structure of large EU banks, the Commission services have conducted a public stakeholder consultation. The consultation was open for eleven weeks (16th May 2013– 11th July 2013). It contained both qualitative and quantitative sections, with the former focusing on questions related to the need for EU action and the different options for legislative reform, and the latter containing a data template for banks to provide data on short and medium term implications of different reform scenarios on their balance sheets. This document summarises the responses to the qualitative part. This note follows the structure of the consultation document and provides a high-level summary of the nature of responses of different stakeholders. The following graphs accompanying each section of the consultation document indicate the proportions of each category of respondents that gave a certain answer⁴².

The Commission services received 540 replies. These responses came from the expected type of respondents: banks and other financial institutions, corporate clients, investors, public authorities, and consumer associations and individuals (analysis shown in Graph 1). However, while the composition is fairly traditional, the number of responses from individuals (439) and consumer associations (11) stand out. The majority of these 439 replies took either the exact, or abbreviated, form of a recently-publicised Finance Watch response to the consultation.

Graph 1: Overall breakdown of consultation respondent by stakeholder type.

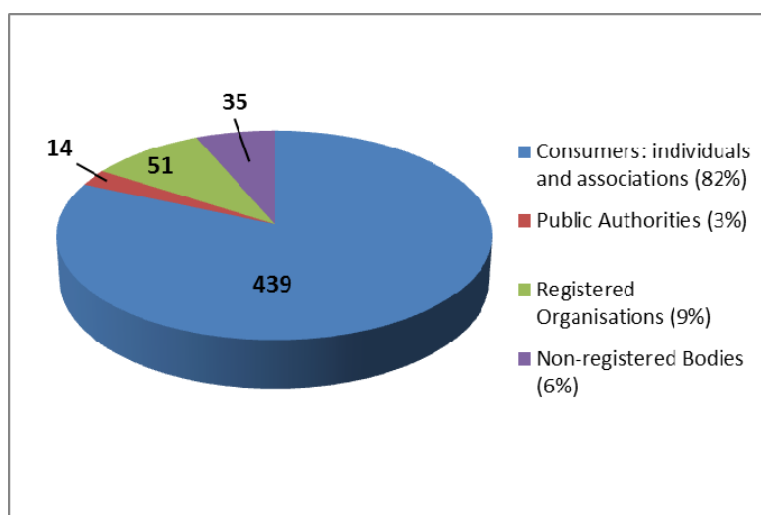

⁴² Throughout, figures in parentheses following the chosen option indicate how many positive responses this option received; not necessarily the number of individual stakeholders who would choose the option. That is, respondents were not restricted to choosing a single preferred option for each question. It is for this reason that the sum of the figures in the graphs below may equate to a number greater than the total number of responses received.

The following graph shows the breakdown of all other responses by nationality. It may be worth noting that the relatively high number of responses from Belgium is composed mainly of international organisations headquartered in Belgium, but representing several European countries and member associations.

Breakdown by nationality of the 439 responses from consumer individuals is excluded, as respondents did not indicate within their response from which Member State they wrote. The majority of consumer individuals responded in English (270), followed by French (131), German (22), Italian (15), and 1 response was written in Danish.

Graph 2: Overall summary of responses by nationality

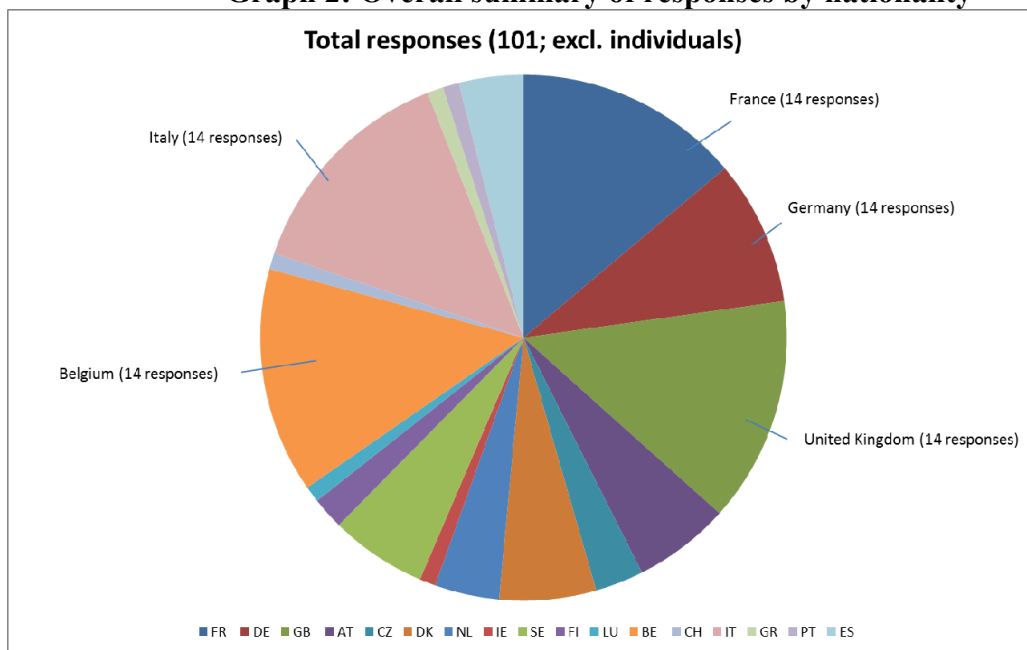

1. PROBLEM DRIVERS

The consultation document outlined the problems that continue to affect the EU banking sector and outlined the potential contribution structural reform could make in addressing those problems. Stakeholders were then asked whether structural reform of the largest and most complex banking groups could address and alleviate these problems. The answers are summarised in Graph 3.

Graph 3: Are banking structure reforms relevant?

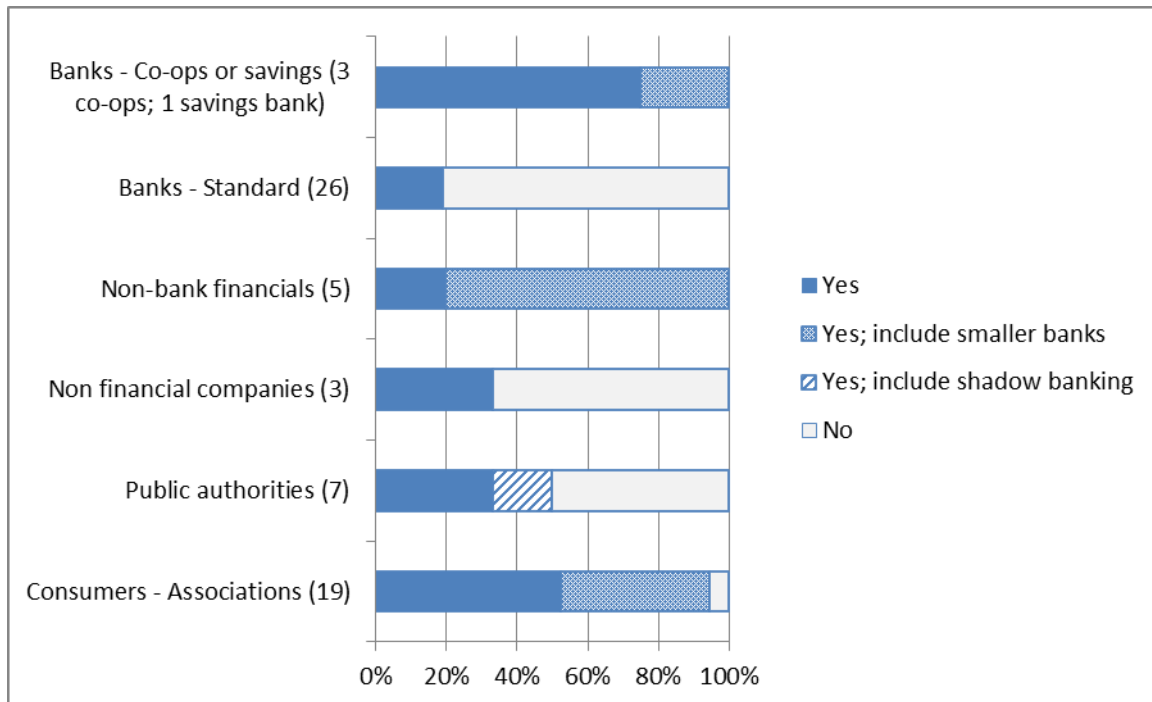

The above graph, showing the type of response as a percentage of overall responses from each group of stakeholder, excludes the responses of individual consumers. This large group's inclusion skews the graphic representation. Individuals responded in large numbers in favour of the reform proposal (433 out of 439 in favour, but with 4 disagreeing with the proposal). Along with the above graph, it is clear that there is a distinct fault line between the responses of banks, on the one hand, and consumers and non-bank financials on the other hand. The former are to an overwhelming extent against structural separation (with the exception of some cooperative banks). The latter are largely in favour. The views of other categories are more balanced. Corporate customers, while acknowledging the need to address TBTF, express opposition, based on the potential impact of such reforms on the cost of financing.

As shown in the graph, some cooperative banks, consumer associations, non-bank financial companies, and public authorities added the comment that they agreed with the proposal, but that it should target smaller banks and should consider the detriment of a shadow banking sector in the proposal process.

2. SUBSIDIARITY

The consultation document then highlighted the on-going reforms within Member States and outlined the potential benefits of action at the EU level, that is, to preserve the integrity of the internal market. It then asked for stakeholders' views on whether they considered an EU proposal in the field of structural reform necessary.

Graph 4: Is EU action needed?

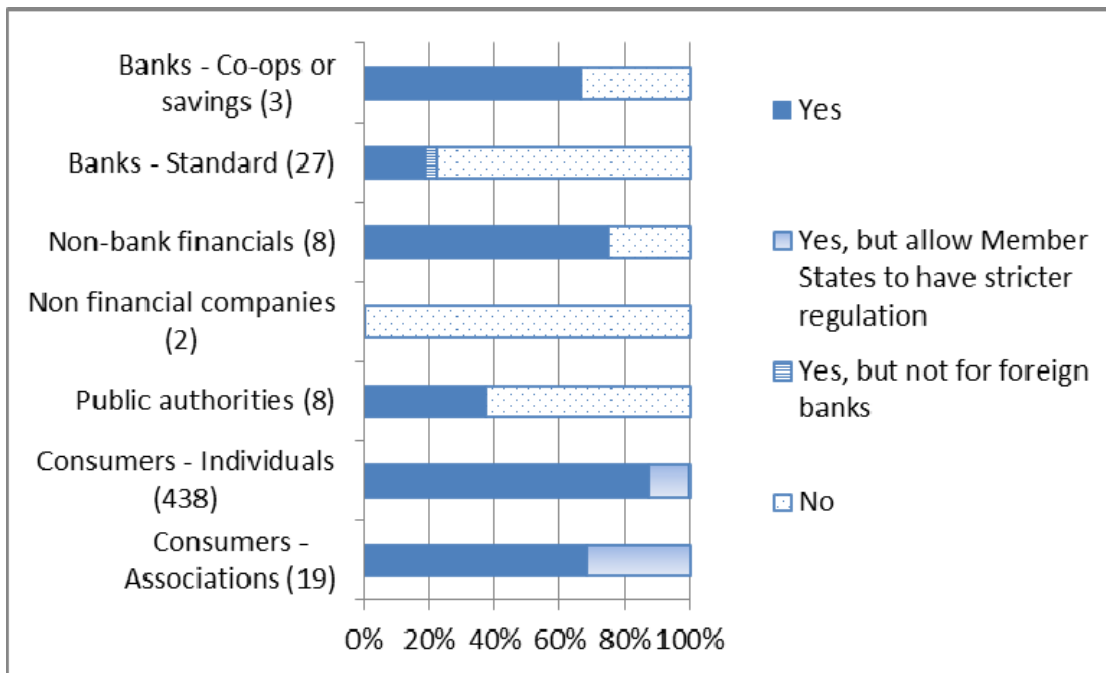

Views on the need for EU action mirror the views on the merits of such reforms in the first place. There is accordingly a large opposition from most banks (excluding cooperatives) and non-financial corporates. Consumer associations and individuals are again unanimously in favour. It may also be interesting to note the relatively high number of consumer responses that supported allowing Member State legislation to "go further," than supranational reform, if possible.

3. POLICY OPTIONS

The remainder of the consultation document asked for views of stakeholders on the three different elements of bank structural reform: the scope of banks to be subject to potential separation, the activities to be separated, and the strength of separation. It also asked for stakeholders' views on the best combination of activities and strength.

3.1. Scope of banks

As regards the scope of banks, the consultation document asked questions related to, first, the threshold for banks to become subject to separation, and second, the extent of supervisory judgement in applying the threshold.

As regards the threshold for separation, the document outlined four options:

- (1) Using the HLEG definition (Assets held for trading and available for sale);
- (2) A more narrow definition for separation, which excludes available-for-sale assets, as they are mostly composed of securities held for liquidity purposes;
- (3) A definition focused on the gross volume of trading activity, which is likely to focus on proprietary traders and market-makers;

- (4) A definition focused on net volumes, which is likely to only capture those institutions that have a higher share of unbalanced risk trading (proprietary traders).

It then asked stakeholders which of the four definitions would be the best indicator to identify systemically risky trading activities. If none of the above, it asked stakeholders to propose an alternative indicator. The views of stakeholders are summarised in Graph 5a. Many stakeholders, particularly consumers, did not respond to this rather technical question. Of those who did, many rejected the HLEG recommendation (option 1). Most banks, as well as public authorities, argue in favour of a risk-based approach. For those banks that expressed an opinion on the four options given (standard and cooperatives and savings), the majority favours option 4 (net volumes). Among other stakeholders, the debate lays between gross and net volumes, with the latter having the most widespread constituency.

Graph 5a: Threshold options by total consultation response.

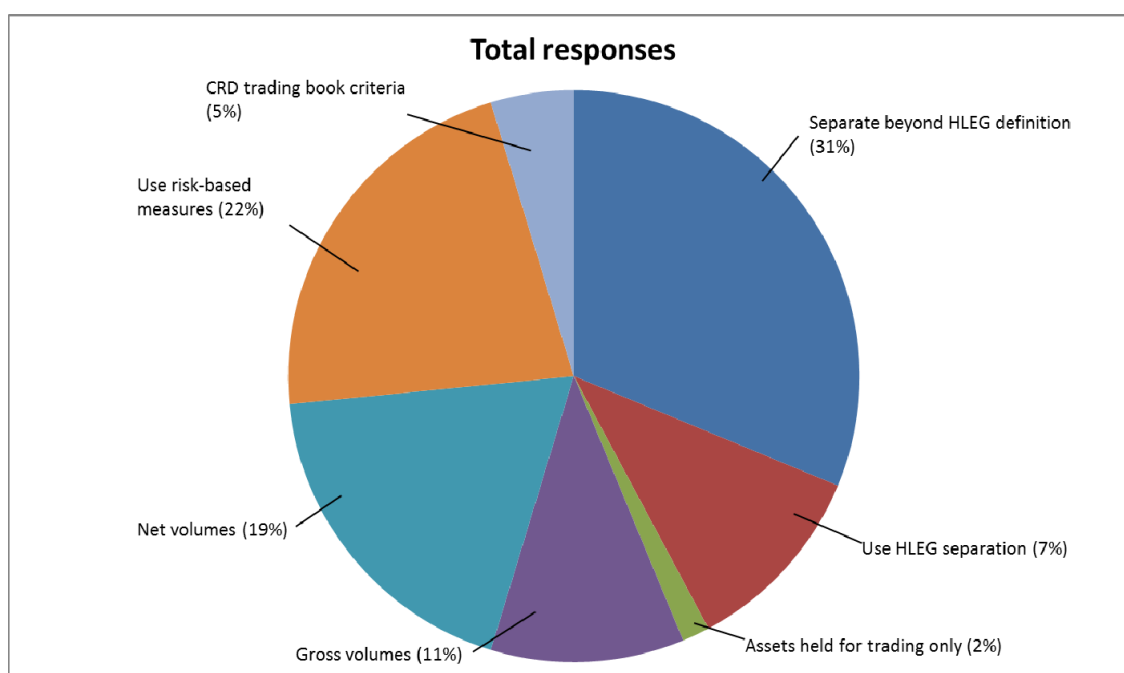

Graph 5b: Threshold options by respondent

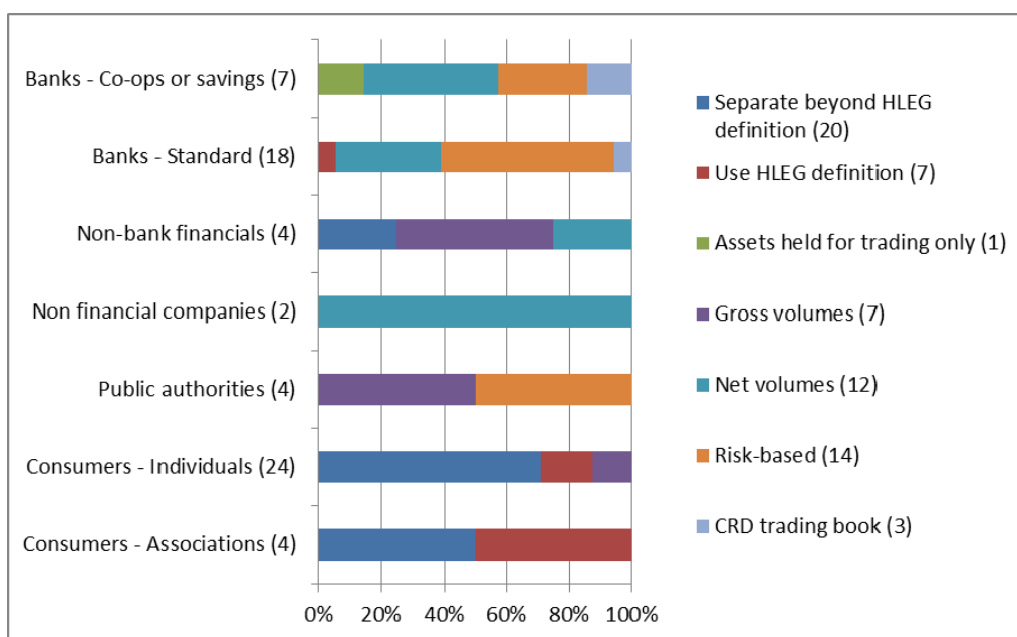

As regards the degree of supervisory judgement, the consultation document outlined three options:

- (1) *Ex post* separation subject to constrained discretion by the supervisor;
- (2) *Ex ante* separation subject to evaluation by the supervisor; or
- (3) *Ex ante* separation.

It then asked for stakeholders' views on which would be the most appropriate approach, including suggestions for alternatives. The pattern of responses is similar to views of the fundamental merits of structural separation. Bank respondents however are more divided, already showing some acceptance of separation with limited supervisory discretion, mostly to ensure a level playing field in the market and ensure legal certainty. The graph below does not reflect the responses of individual consumers, as the volume of these respondents again will skew the graphic illustration. The consumers who did answer this question (216) expressed complete support for no supervisory discretion.

Graph 6: The degree of supervisory judgement (excluding individual consumers)

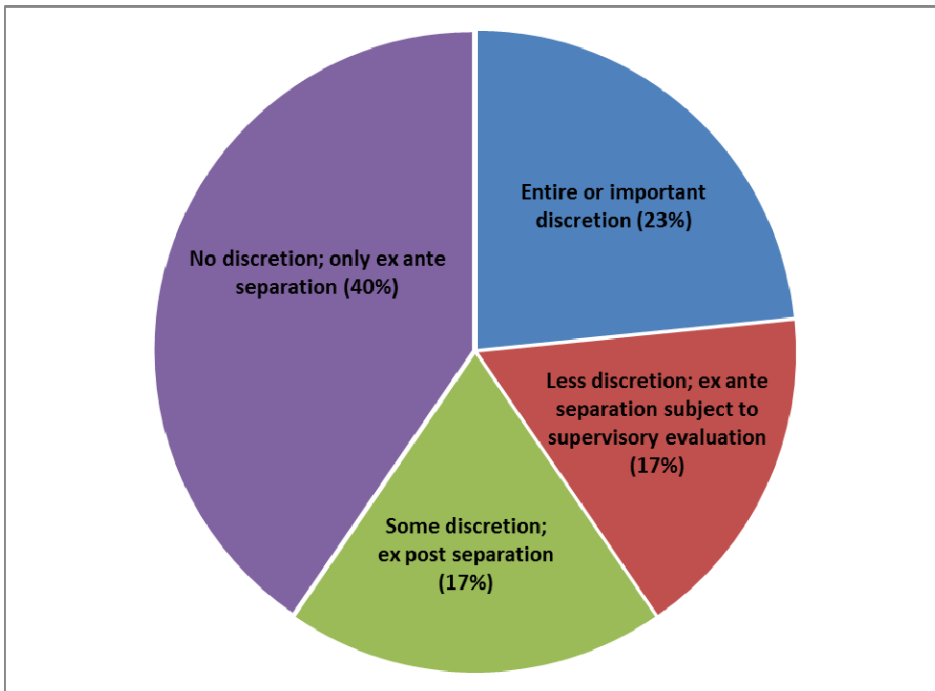

Of those non-individuals who responded to this question, 3 of the 18 total standard banks responded favourably to leaving no supervisory discretion, with ex ante separation. The graph below depicts the composition of respondents (excluding the 216 individual consumers) who responded in the same way.

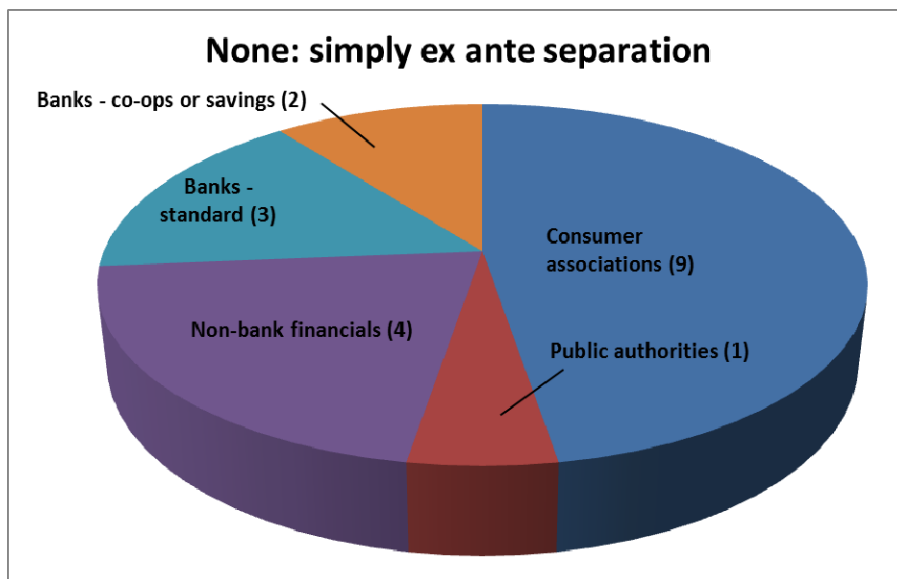

Contrastingly, a third of all standard banks who responded to the consultation replied in favour of either entire or important discretion:

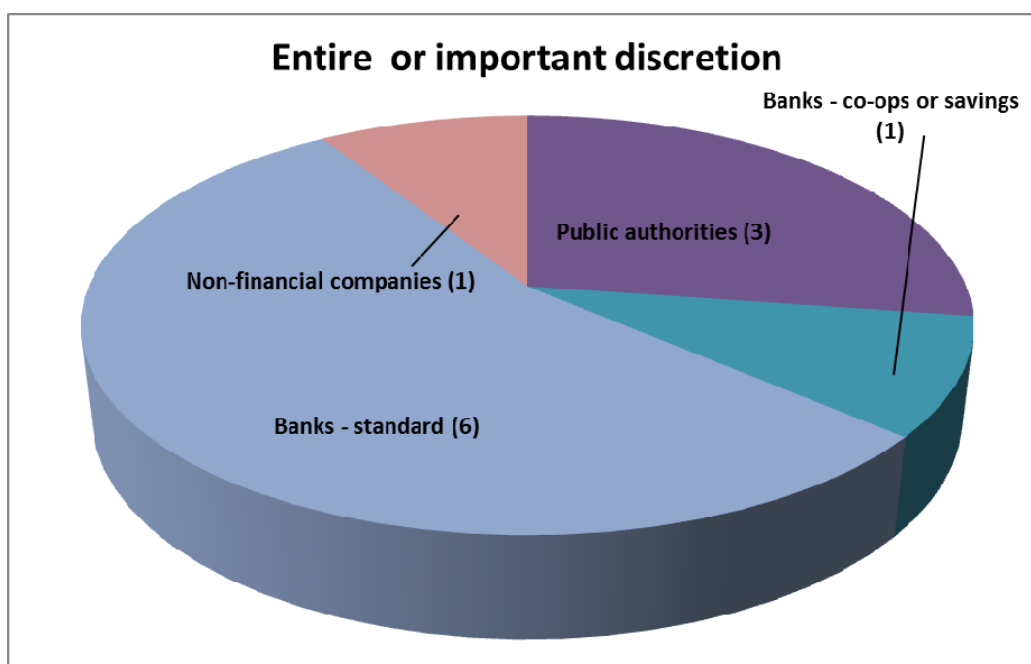

3.2. Activities

The consultation document highlighted the broad range of activities banks may engage in and provided three scenarios for separation, ranging from only some activities (e.g. proprietary trading, PT) being separated and the trading entity thus remaining ‘narrow’ and the deposit-taking entity ‘broad’; to a scenario where many activities (e.g. all wholesale and investment bank activities, WIB, would be separated and the trading entity accordingly becoming ‘broad’ and the deposit entity correspondingly ‘narrow’. More specifically:

- (1) “Narrow” trading entity and “broad” deposit bank;
- (2) “Medium” trading entity and “medium” deposit bank; or
- (3) “Broad” trading entity and “narrow” deposit bank.

It then asked a question specifically related to the separation of market-making (MM) and underwriting activities. This question has served as a foundation for classifying responses into the three options highlighted above.

Responses here again reflect the general pattern of replies. Bank responses are divided between those who argue against separation, and those who argue that if there is to be separation, then it should only focus on proprietary trading. This sentiment is echoed by corporates, who argue in favour of an as narrow separation as possible in order not to affect their access to (low cost) financial services. Individuals and consumer associations on the other hand favour option 3, i.e. separation of all investment bank activities.

Graph 7: Which activities should be separated?

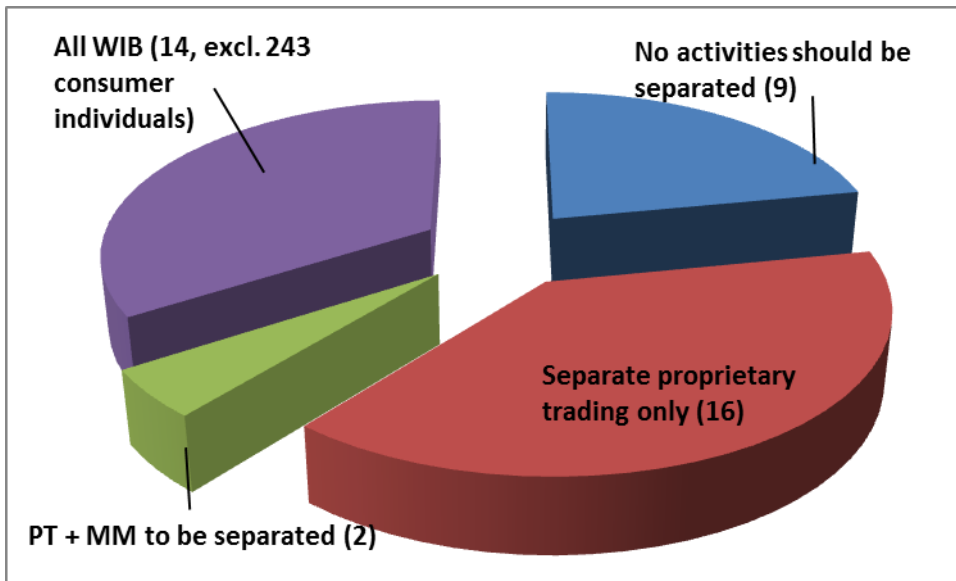

Consumer individuals are excluded from the above graph, as 243 extra favourable respondents skewed the scale of the chart. The individuals who were in favour of the reform and who responded to the question, however, were all in favour of separating all wholesale and investment activities. As shown in the graphs, standard banks who accept a certain degree of separation favour separating proprietary trading only from the deposit-taking entity, much like non-financial companies and some public authorities.

Graph 8: Activities to be separated, by respondent

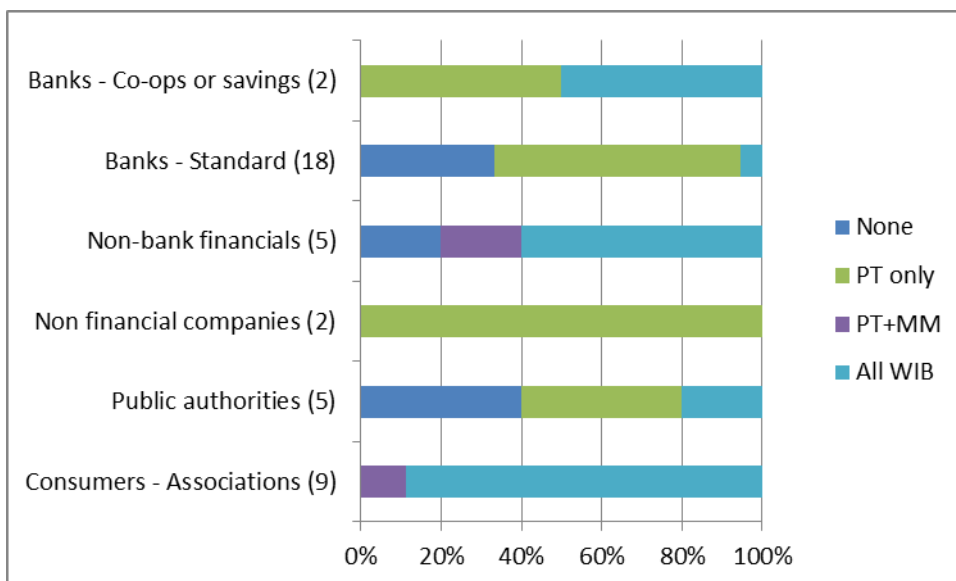

The consultation document also highlighted the particular case of risk management products, where the banking group and its constituent entities not only need to be able to engage in

prudent risk management practices for treasury purposes, but where the deposit entity may provide risk management products to its clients. The consultation document therefore asked if deposit-taking entities should be allowed to directly provide risk management services to clients, and if so, whether any additional safeguards should be considered.

Many stakeholders did not respond to this rather technical question. Of those who did, many (most banks) responded in favour of the deposit-taking entity being able to provide such services. Some argued in favour of safeguards (e.g. simple derivatives, caps). Consumers, some non-bank financials (investors) and public authorities were against such provisions.

Graph 9: Should the deposit entity be able to provide risk management products?

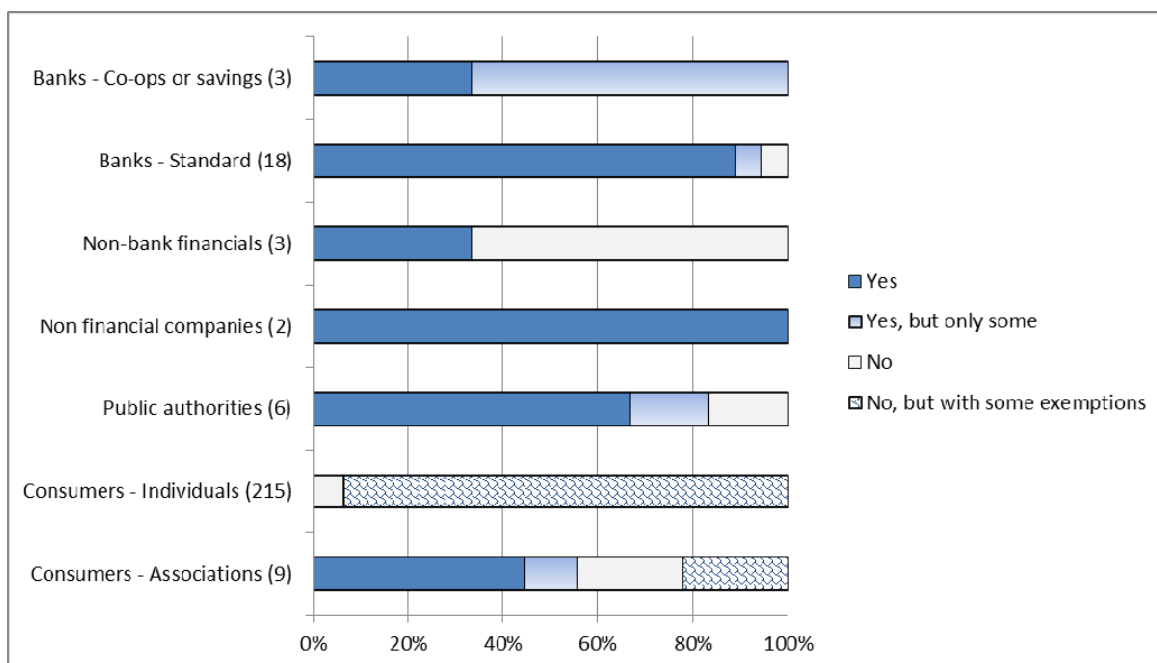

3.3. Strength of separation

The consultation document subsequently highlighted different forms of separation and indicated that the Commission services were considering three degrees of strength:

- (1) Functional separation with economic and governance links restricted according to current rules;
- (2) Functional separation with tighter restrictions on economic and governance links; or
- (3) Ownership separation (full prohibition).

It then asked stakeholders for their views on the pros and cons of stricter legal and economic separation, as well as views on full ownership separation.

- As regards legal and economic separation, the classical pattern can be observed, with some cooperatives being concerned about the potential implication of structural reform on their reverse-ownership structure;

- As regards ownership separation, this has polarised opinion, with most banks highlighting the costs, and consumer associations and individuals and some non-bank financials highlighting it as the simplest and most effective option in the longer term.

Graph 10: Is there a case for stricter legal separation?

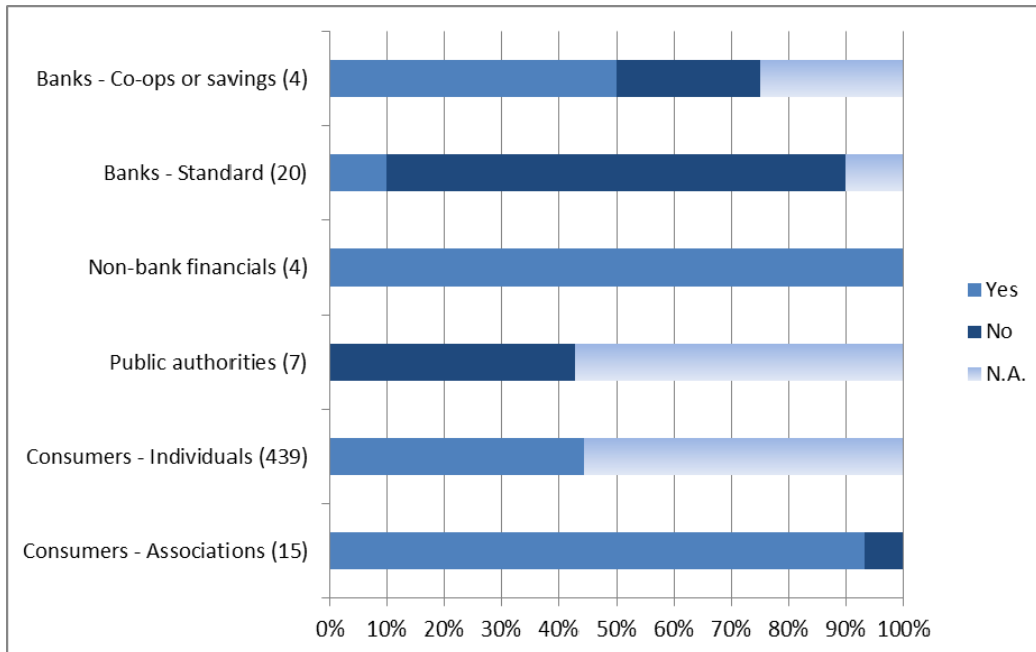

Graph 11: Is there a case for stricter economic separation?

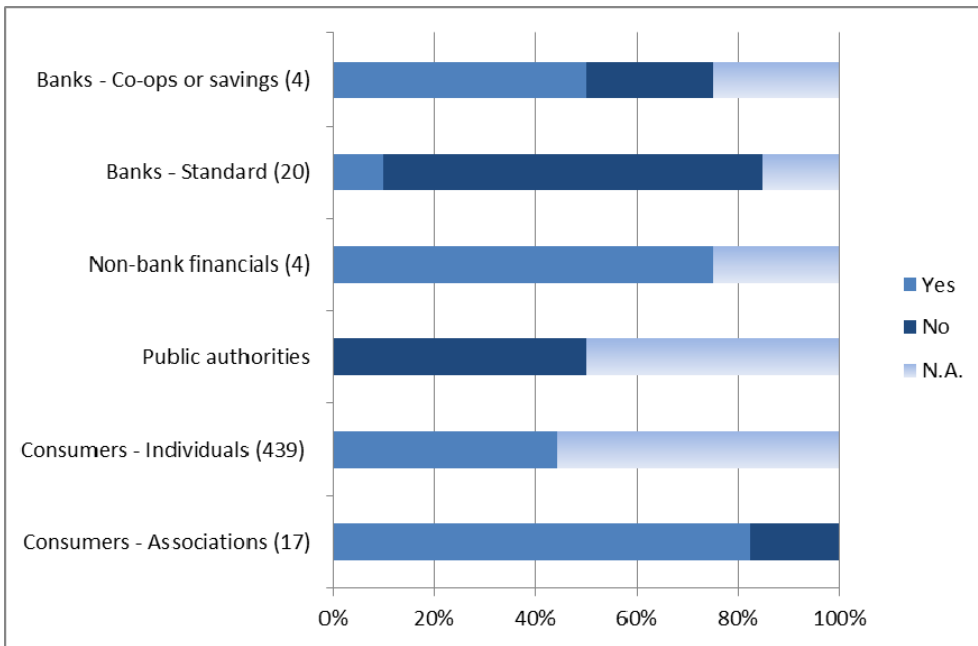

Graph 12: Is there a case for full ownership separation?

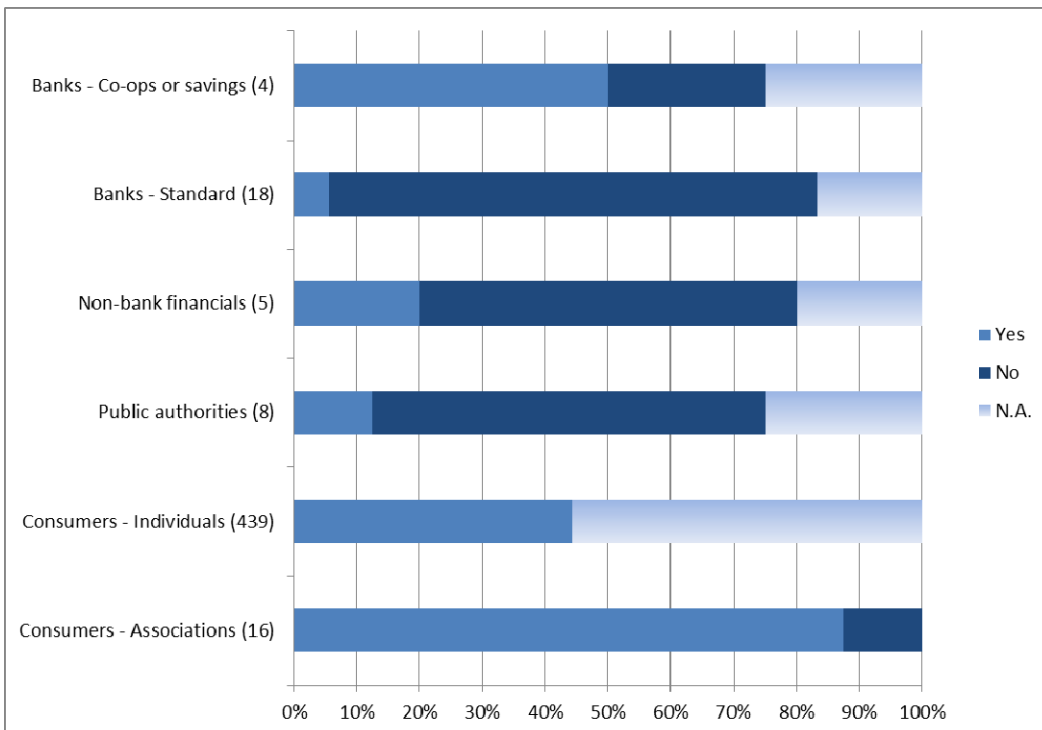

Non-financial companies have been excluded from the above graphs, as they consistently did not reply to the questions on the strength of eventual activity separation.

As shown by comparing the three graphs, there is a high level of consistency across respondents. That is, a large proportion of respondents in favour of increased economic separation are also in favour of increased legal separation, for example.

3.4 Options

The consultation document then highlighted a number of preliminary and illustrative combinations of different degrees of activity restrictions and separation degrees that would be subject to further assessment in terms of costs and benefits (Table 1).

Table 1: Overview of policy options

Activities\ strength	Functional separation 1 (SUB) <i>Current requirements</i>	Functional separation 2 (SUB+) <i>Stricter requirements</i>	Ownership separation <i>Ownership separation</i>
Narrow trading entity/ broad deposit entity <i>E.g. Proprietary trading + exposures to HF (PT)</i>	Option A	Option B [≈ FR, DE baseline]	Option C [≈ US Volcker]
Medium trading entity/ medium deposit entity <i>E.g. PT + market-making (MM)</i>	Option D	Option E [≈ HLEG; ≈ FR, DE if wider separation activated]	Option F
Broad trading entity/ narrow deposit entity <i>E.g. all investment banking activities</i>	Option G	Option H [≈ US BHC; ≈ UK]	Option I [≈ Glass-Steagall]

It then asked stakeholders whether (i) the above matrix captured a sufficiently broad range of structural reform options and (ii) which option would, in stakeholders' views, best address the problems identified. Fundamental views show up again, with a large portion of banks expressing a blanket opposition to structural reforms or endorsing option A (PT Only). Consumer associations and individuals, however, argue that option E (HLEG) is the minimum effective option and express a preference for either option H (UK ICB) or I (Glass-Steagall).

Graph 13: Preferred reform approach

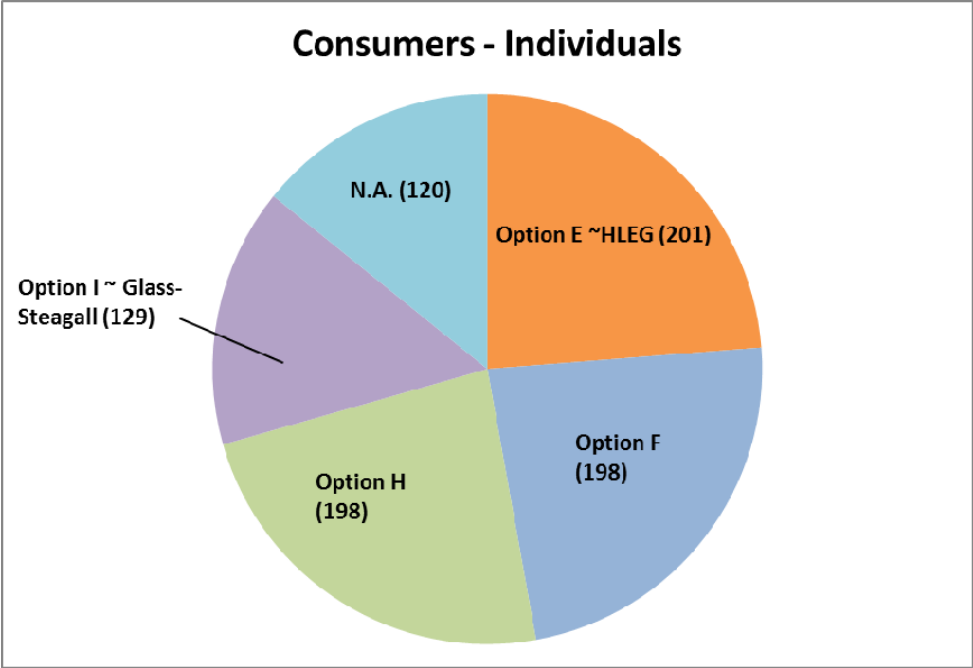

As with several of the other responses, it is worthy to note that the respondents do not necessarily add up to the total number of responses received by the Commission. For this question in particular this is especially evident, as many stakeholders expressed their preference for Option E as a minimum option, but said that combinations such as H and I or F and I would also work.

Only one public authority cited capping total assets as the preferred reform method. Others were divided fairly evenly over the range of options.

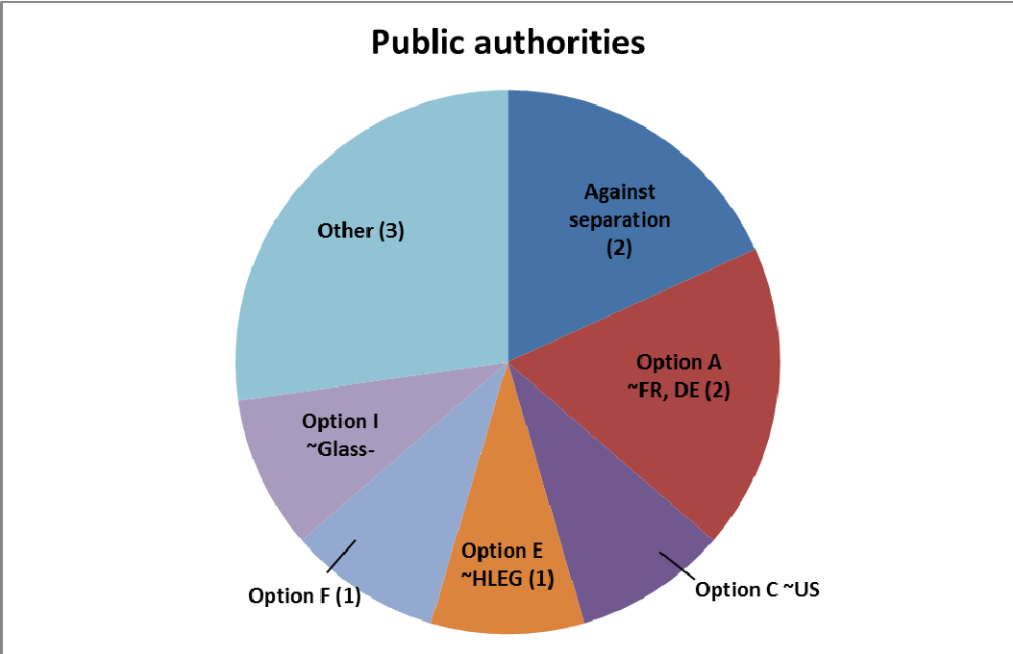

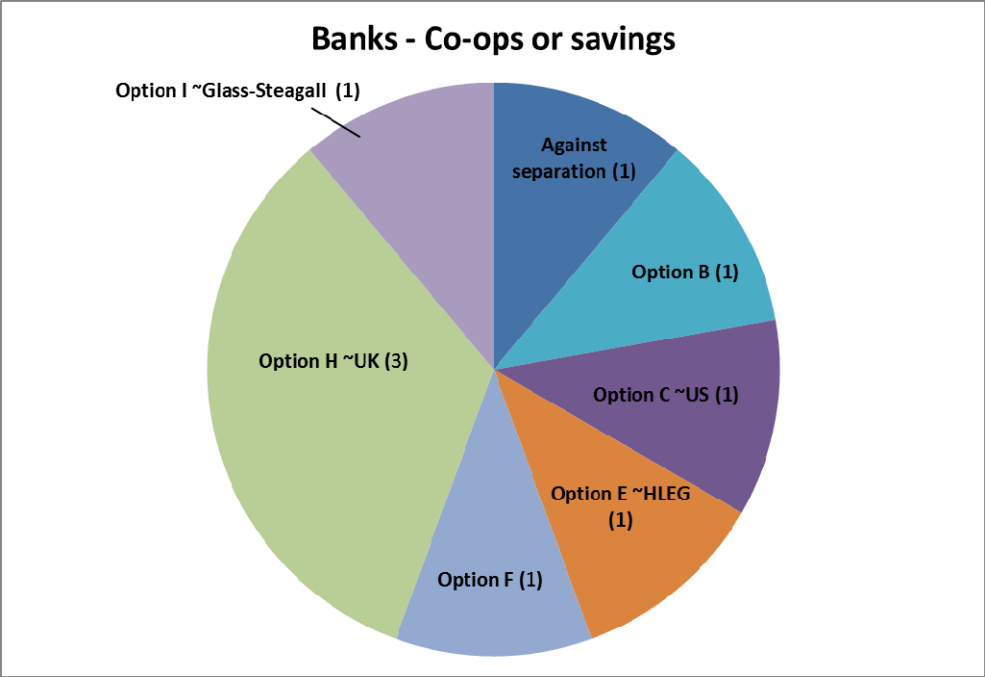
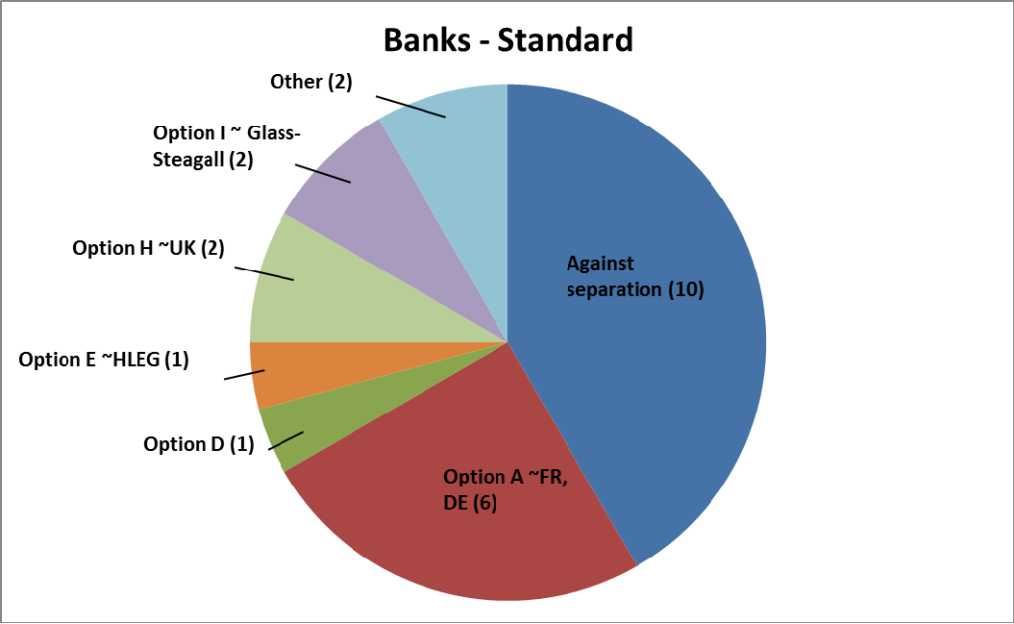

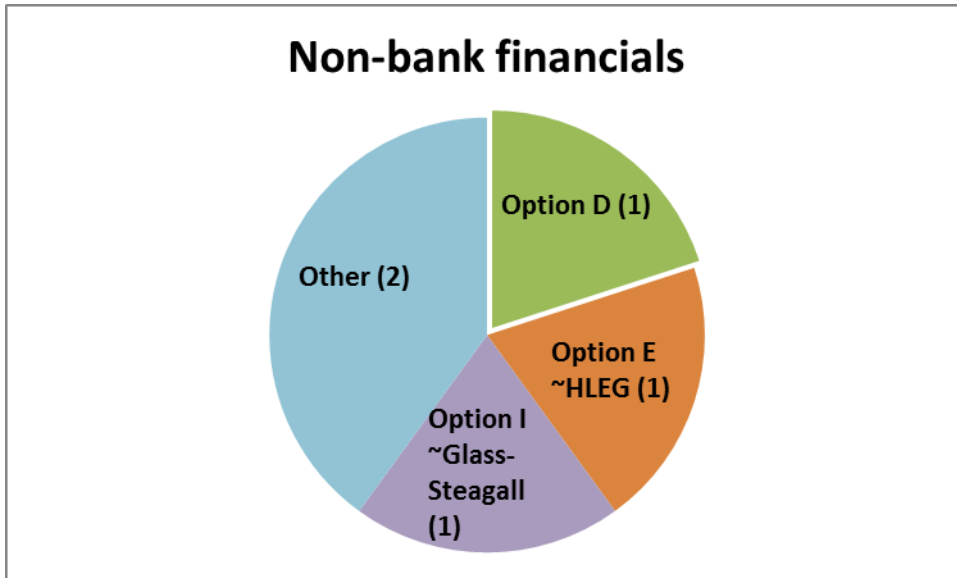

With regards to consumer associations, four respondents preferred option H (~UK), while 14 respondents preferred the Glass-Steagall type option on structure, or option I for separation. Only Option G received no support from any respondent.

4. CONCLUSION

While consumers are overwhelmingly in favour of the proposal for structural reform and banks are predominantly against, where respondents addressed the numerous detailed choices within the proposal, they displayed a wide range of views. Of course especially for the final policy option and the divide between banks and consumers regarding supervisory discretion, some dominant choices appear. Accompanied by several detailed, analytical responses to the consultation document, as well as the quantitative feedback from banks, the Commission has gleaned much information from the varied group of respondents.

ANNEX A3 – ASSESSING THE COMPLEMENTARITY OF STRUCTURAL SEPARATION

Since the start of the financial crisis, the European Commission (the "Commission") has – in parallel to the management of the crisis by national authorities, state aid control by the Commission, and non-standard interventions by central banks – engaged in an ambitious overhaul of financial system regulation and supervision.⁴³ The objectives of those reforms have been to create a safer, sounder, more transparent and responsible financial system that works for the economy and society as a whole. In particular this has been done by: (i) strengthening capital requirements related to trading, securitisation and derivatives activities (the CRDII and CRDIII)⁴⁴ and to improve both the quantity and quality of bank capital more broadly (the CRR/CRDIV)⁴⁵; (ii) introducing rules that enable authorities to better manage failing banks (the BRRD)⁴⁶; (iii) creating a stronger micro- and macro-prudential system of supervision at EU level by the creation of the European Supervisory Authorities and the European Systemic Risk Board (the "ESRB") and the proposal on the Single Supervisory Mechanism (the "SSM") as a fundamental pillar of the Banking Union; (iv) strengthening the regulatory framework for the trading of different classes securities, the provision of investment services and activities and the treatment of OTC derivatives (the MiFID review and EMIR).

The case for structural reform depends on demonstrating in what ways such reforms could complement those reforms. The purpose of this annex is not to provide an in-depth, comprehensive description of the details of all these large and complex reforms. Instead, this annex: (i) briefly outlines the objectives and principles of the major reforms either agreed or currently under negotiation; and, (ii) assesses the extent to which bank structural reform could complement already existing tools that provide powers to take measures aimed at: (a) strengthening bank capital, governance, supervision, recovery and resolution, derivatives clearing and trading, and, taxation of financial transactions, and (b) restricting or limiting the legal and economic organization and operation of banks. The annex also takes stock of how bank structural separation would affect the general tension of increased regulation leading to a shift of activities towards the less regulated shadow banking sector.

⁴³ For an overview of these measures and their current state of play, see European Commission (2013), "Towards a stronger financial sector to support growth" (http://ec.europa.eu/internal_market/publications/docs/financial-reform-for-growth_en.pdf).

⁴⁴ Directives 2009/111/EC and 2010/76/EC.

⁴⁵ Proposals for a Directive on access to the activity of credit institutions and the prudential supervision of credit institutions and investment firms, and a Regulation on prudential requirements for credit institutions and investment firms, COM(2011)452 and 453 of 20 July 2012 – also referred to as the CRD IV package. Political agreement between the European Parliament and the Council was reached in April 2013.

⁴⁶ Proposal for a Directive establishing a framework for the recovery and resolution of credit institutions and investment firms and amending Council Directives 77/91/EEC and 82/891/EC, Directives 2001/24/EC, 2002/47/EC, 2004/25/EC, 2005/56/EC, 2007/36/EC and 2011/35/EC and Regulation (EU) No 1093/2010, COM/2012/0280 final - 2012/0150 (COD). Political agreement was reached in July 2013.

1. CAPITAL

Banks play a critical role for the functioning of the financial system and the economy as a whole. The business of credit intermediation is nevertheless inherently unstable. Prudential requirements to back up a bank's balance sheet by a certain level of own funds in order to absorb losses have therefore since a long time been a key instrument to control and limit these inherent risks. The financial crisis highlighted shortcomings both as regards the level and loss-absorbing nature of banks' own funds.

Efforts have therefore been undertaken at both international (Basel Committee on Banking Supervision (the "BCBS")) and European level (changes to the Capital Requirements Directive (the "CRD")) to improve the quantity and quality of bank capital. At the early stages of the crisis, capital requirements related to trading, securitisation and derivatives activities were strengthened in order to address the materially undercapitalised trading book exposures (the CRDII and CRDIII). The crisis also initiated a more fundamental review of the capital requirements framework at international level (Basel III), requiring banks to have more and better quality capital overall. The BCBS has also developed additional capital buffers for banks that are of global systemic importance. These changes have been incorporated into European law by the recent CRDIV.⁴⁷

The reforms to bank capital requirements will reduce incentives to take excessive risks. It will also enable banks to absorb more losses before defaulting. These two effects will reduce the probability of default. The increased capital requirements on banks' trading books may also reduce banks' rapid balance sheet growth.

Even so, risk weighted assets as compared to total assets for large cross-border banks, which typically have an important trading book, are significantly lower than for other banks.⁴⁸ Moreover, the risk-based capital requirements based on value-at risk ("VaR") model calculations can still be small compared to the size of trading assets.⁴⁹ This explains why some measures have been taken⁵⁰ and that standard setters at both international (BCBS) and European level (by the European Banking Authority (the "EBA")) are assessing the consistency and accuracy of the risk-weighted asset approach.⁵¹

The subsequent revisions to the Basel agreement and the CRD build on the same regulatory approach as the previous Basel framework (risk-based capital requirements), even though it

⁴⁷ The exact rules in some areas, notably liquidity, remain to be fully specified.

⁴⁸ "The ratio of risk-weighted assets to total assets differs significantly between banks. It is remarkable that the banks with the highest amount of trading assets, notional derivatives, etc. (i.e. banks that are least "traditional") tend to have the lowest ratio." Report of the HLEG, p. 43.

⁴⁹ "[...] for a sample of 16 large EU banks, the capital requirements for market risks vary between close to 0% to just over 2% of the total value of trading assets, the average being close to 1%." Report of the HLEG, p. 48.

⁵⁰ E.g. the use of stressed VaR as part of Basel 2.5's revisions to the market risk framework.

⁵¹ European Banking Authority (2013), "Interim results of the EBA review of the consistency of risk-weighted assets. Top-down assessment of the banking book", February 2013; Basel Committee on Banking Supervision (2013), "Regulatory consistency assessment programme (RCAP) – Analysis of risk-weighted assets for market risk", January 2013.

also introduces a leverage ratio designed to serve as a backstop to risk-based capital requirements. Trading, securitisation, short term wholesale funding and other activities were all supposed to be assessed by supervisors as part of the Pillar 2 supervisory review process introduced by Basel 2, as well as partially by the Pillar 3 process of market disclosure. It therefore remains to be seen whether these revisions will address all the difficulties of supervision and market monitoring.

In addition, CRDIV enhances the Pillar 2 supervisory review process by providing supervisors with powers to impose certain structural measures on a bank when it is at risk or pose a risk to the entire financial system.

The capital requirements framework sets capital and liquidity requirements that depend on the riskiness of the individual entities and/or of the consolidated group. Structural reform could therefore complement the capital requirements framework by imposing *ex ante* stricter capital constraints on specific activities which are likely to generate the most risk. If as a result, complex activities no longer benefit from being covered by the public safety net, this would remove one source for excessive growth of such activities.

More fundamentally, capital requirements do not address conflicts of interest and cultural problems, and as such do not address the problem drivers associated with structural reform. Structural reform (i.e., separation) combined with strengthened governance rules could therefore prevent the investment bank side to affect the business of the commercial banking part of an integrated group.⁵²

Moreover, irrespective of the changes to capital requirements that increase the amount of capital that needs to be held, banks may still have significant incentives for engaging in risky activities that yield substantial profits, as they do not have to fully cover the potential losses arising from such activities.⁵³ Given limited liability as regards losses, the activities in question would accordingly yield excess private returns. This could induce a broad-based shift towards these activities, with an increase in systemic risk being the consequence.

Finally, structural reform could also complement the CRDIV powers to impose structural measures by setting a uniform standard for how relevant authorities should review the need for and subsequently apply structural measures.

Structural bank reforms could complement the reforms related to capital requirements by:

- **Imposing *ex ante* constraints on specific activities**, as opposed to *ex post* capital requirements that depend on the riskiness of the individual entity and/or of the consolidated group;
- ***Ex ante* addressing remaining incentives to engage in excessive trading activities** over credit activities. Structural reform would be a more direct way of addressing excess returns resulting from insured deposit the benefits of which currently flow freely throughout integrated groups. It could lead to a better pricing of risk, which over time could help reducing excessive trading activity and thereby limit the build-

⁵² Ibid.

⁵³ See Annex A5, “Analysis of possible incentives towards trading activities implied by the structure of banks’ minimum capital requirements.

up of systemic risk. This could also complement the systemic risk charges for SIBs by adding another disincentive towards banks excessively expanding their risky trading activities, thus putting a break to the main source of bank growth in recent years;

- Allowing a more effective and transparent **tailoring of capital requirements to the different legal entities**. A structural separation would entail different entities holding separate capital and liquidity buffers aligning the prudential requirements more closely with the risk. This promotes market discipline;
- Setting a **uniform standard** for how relevant authorities should review the need for and subsequently apply structural measures; and
- **Facilitate Pillar 3 market monitoring** by providing more transparent group structures that match main business lines, and by providing more disclosure of the data of the segregated business entities.

2. GOVERNANCE

One of the key contributors to the financial crisis has been the implicit or explicit guarantees of bank deposits and other liabilities, which induced excessive risk-taking (including, for example, high leverage and own-position taking) and bad lending and acquisition decisions. The problem was exacerbated by ineffective governance arrangements within banks, which did not offer sufficient checks and balances within their internal processes, resulting in a lack of effective oversight of management decision-making and excessively short-term and risky management strategies. This was compounded by ineffective ownership and control due to fragmented shareholder structures. Is that not the same thing?

Another contributing factor has been passive debt holders. This passivity is partly due to the complexity of banks. Banks are engaged in many activities and active across many markets and their balance sheets are accordingly complex and opaque. This limits the ability of investors to fully understand banks and exercise effective scrutiny. The complexity is mirrored in e.g., the prudential regulation of banks (e.g., the Basel capital adequacy framework), which is also complex and difficult for investors to understand. Accordingly, investors have not fully exercised the "watch-dog" function granted to them under Basel's pillar 3 (market discipline) framework.

The high leverage and guarantees have encouraged boards to give undue focus to return on equity (and make decisions that do not meet a bank's true overall cost of capital).

Current reforms address many of these problems, notably by imposing leverage limits (the CRR/the CRDIV), by strengthening banks' and investment firms' internal governance structures, enhancing risk oversight by boards, improving the status of the risk management function and ensuring effective monitoring of risk governance by supervisors (the CRDIII and CRDIV and the MiFID review) and by more clearly exposing debt holders to risks of failure (the BRRD provisions on bail-in). However, current reforms do not address the intra-group subsidies arising from the public guarantees on deposits or the issues arising from the complexity of group structures. Furthermore, internal management structures (e.g., boards) are an imperfect substitute for market discipline.

Structural reform could therefore **strengthen bank governance** by e.g., providing for separate and independent governance structures for deposit taking banks and the trading entity of a group. Such decentralised governance structures could lead to better managerial focus on managing the risks specific to those business lines.

3. SUPERVISION

Bank supervision is essential to monitor a bank's risk profile and intervene if the bank's own management does not take appropriate action to reduce excessive risks. Since the start of the crisis, the CRD has been strengthened to enhance and harmonise national supervisors' powers. Also the review of the MiFID has reinforced the powers of securities regulators, at national and European level (the European Securities and Markets Authority). Moreover, most if not all supervisors in the EU have reviewed their supervisory approaches and increased their resources.

Supervision of cross-border banks represents particular challenges. The financial crisis laid bare a gap between transnational banking markets and cross-border groups and essentially national supervisors. The CRDII package recognised the important role of Colleges of Supervisors for these purposes. Since 1 January 2011, the newly created EBA coordinates national banking supervisors. The EBA has binding mediation powers, notably as regards approving banks' internal risk models, and the Pillar 2 supervisory review. In order to strengthen macro-prudential supervision, the EU has set up the European Systemic Risk Board (the "ESRB") that is responsible for issuing early warnings and recommendations in relation to the build-up of systemic risk. In order to address the negative feedback loops between bank stability and Member States' finances, the European Council in June 2012 asked for a road map to achieve a genuine Economic and Monetary Union. Following a specific call from the Euro Area Summit, on 12 September 2012 the Commission presented legislative proposals for the establishment of a single supervisory mechanism within the EU, as a first step towards Banking Union. Political agreement was reached in December 2012 and the SSM should become fully operational in summer 2014.

While the above measures have and will significantly strengthen the supervision of cross-border banks in Europe, supervision of the largest and most complex banks in the EU will remain challenging, given their complexity, size, and interconnectedness and with business lines where risk profiles can change significantly in a very short time and thereby risk outpacing supervisory control.

Structural reforms could complement these reforms by **adding further transparency** by e.g., separating the activities that are most complex into a separate legal entity. This could **facilitate supervision and could allow market discipline to more effectively assist supervisors.**

4. RECOVERY AND RESOLUTION

Neither strict prudential rules nor close supervision can exclude bank failures. In order to ensure that such failures can be managed without impact on the stability of other financial institutions or financial markets, and without recourse to public resources, the Commission proposed in June 2012 a Bank Recovery and Resolution Directive (the BRRD) requiring all Member States to have in place resolution regimes, consisting of a number of elements: (i) an

obligation on banks and certain investment firms to draw up recovery plans and on authorities to prepare resolution plans; (ii) a power to authorities to require changes to banks legal or operational structure if they present an obstacle to resolvability; (iii) early intervention powers; (iv) a harmonised set of resolution powers (including e.g., bail-in, whereby the bank would be recapitalised with shareholders being wiped out or diluted and creditors having their claims reduced or converted to shares); and, (v) the creation of dedicated resolution funds in order to ensure that resolution authorities can resolve banks without recourse to taxpayers' money. Negotiations in the European Parliament and the Council on the proposal have reached an advanced stage and are about to close.

The implementation of this proposal would make it easier to stem bank problems at an early stage as well as making it easier to resolve banks once they are beyond the point of repair. It would thus help to address one of the major problems highlighted by the crisis, i.e., the inability of banks to default in an orderly manner without leading to systemic disruptions.

This framework, (combined with the proposals to maintain resolution and supervision of larger euro area banks at the supranational level through the Single Resolution Mechanism and the SMM) addresses impediments to resolving banks in an orderly way. Nevertheless, structural separation could facilitate the effective and timely resolution of banks. First, structural separation along the lines considered in the main report would facilitate resolution because risky activities would either no longer feature on a bank's balance sheet or be lodged in a separate subsidiary ring-fenced from the rest of the group. In either case, the risks would have less potential to contaminate the remaining part of a bank's activities.

Second, while the implementation of an effective bank recovery and resolution framework is a critical part of the on-going financial reform programme, the preparation of recovery and resolution plans (RRPs) will be particularly challenging for especially the largest EU banking groups, given their organisational complexity, interconnectedness, international scope, and ability to rapidly expand their balance sheet.⁵⁴ Structural banking reform can therefore facilitate resolvability.⁵⁵ More specifically, by complementing the RRP efforts, structural reform will be able to benefit from and build on the resolvability assessment conducted under the BRRD framework, and spur a mutually reinforcing progress toward removing impediments to recovery and resolution for the institutions concerned.⁵⁶

Furthermore, resolution may be rendered more complex by the co-mingling of activities within legal entities and financial dependencies within financial groups.⁵⁷ Large EU banking groups have a complex legal and corporate structure, in some cases involving a myriad of different legal entities. During early intervention or resolution this can make it difficult to

⁵⁴ Schich, S. and S. Lindh (2012), "Implicit Guarantees for Bank Debt: Where Do We Stand?", OECD Journal: Financial Market Trends, were on the basis of empirical work unable to generate strong support for the hypothesis that the availability or introduction of special bank failure resolution regimes has been successful in reducing the incidence of implicit guarantees.

⁵⁵ G20 (2013), *G20 Leaders Declaration*, St Petersburg, September 2013.

⁵⁶ See e.g. FSB (2013), *Progress and Next Steps Towards Ending "Too-Big-to-Fail" (TBTF)*, Report of the Financial Stability Board to the G-20, 30 August 2013, highlighting the potential of structural reform to put constraints on excessive risk-taking and contribute to improve resolvability at jurisdictional level. FSB also stresses the complexities in the legal, financial and operational structures of banks.

⁵⁷ FSA (2011), "Recovery and resolution plans", CP11/16.

identify and isolate the root of the problem. Structural reform could enhance the simplification of groups by providing for competent supervisor with the *ex ante* ability to separate certain activities. This simpler structure could facilitate the exercise of the discretionary powers provided for by the BRRD to reset the group structure and to remove further impediments to resolvability stemming from the group operational or legal structures and therefore improve the overall resolvability of banks. Resolving complex banking groups may also be difficult because of the interconnectedness of their subsidiaries and their centralised support functions. Central to the resolution and restructuring of a failing firm (and potentially restoring the viability of the bank, or parts of it) is the ability to identify and assess the losses and the capital required to meet these losses. The writing down of creditor claims and the conversion of debt claims to equity are important steps early in a resolution process. Timing is critical in this process. While it is important to value these losses accurately, it is also important that creditors are treated fairly and quickly, and that any restructuring is done efficiently. Perceptions of a disorderly process can encourage fears of contagion.

Impediments to resolution may appear gradually, for example as a bank's business model or activities change or as deficiencies in the governance structure and performance emerge; but the risk that those impediments carry can materialize suddenly. It could be that a process to remove impediments (operational or governance-related) that rely on multi-agency consultation and cooperation (and in the case of cross-border groups, different authorities and supervisory colleges) would sometimes face challenges in responding quickly enough to ensure that these risks do not materialize. *Ex-ante* separation could mitigate for this by separating the banks that would be the most difficult to resolve, before risks materialize and threaten its viability.

The early intervention and resolution tools are new and authorities need to gain practical experience. For these tools to be effective, authorities need to invest significant resources to scrutinise banks as to their effective recovery and resolvability. This applies in particular to the potential changes to banks' legal and operational structure resulting from the RRP process. The burden of proof to demonstrate the need for such measures will be on authorities, and may be tested in court.

Structural reforms could complement these reforms in a number of ways:

- The top-down – i.e. horizontal legislation setting *ex ante* rules applying to similar entities – structural change implied by structural reform could **complement the preventative powers of the BRRD** that may result in a bottom-up reorganisation (i.e. individual ad hoc actions addressing specific impediments to resolution at individual banks) of banking groups. The combination of these two processes could over time lead to a greater consistency between business lines and legal structures. Structural reform could also facilitate the preventative powers by providing a base upon which they would be exercised, thus limiting the degree of divergent outcomes.
- It is an *ex ante* tool to address a **broader set of objectives** beyond facilitating the orderly recovery and resolution of a banking group. Structural reform also aims at reducing the complexity, interconnectedness, cultural problems and conflicts of interest between the different banking entities within a given group, and aims at reducing the excessive growth of bank balance sheets by constraining the coverage of the public safety nets to specific activities only.

- By simplifying balance sheets and by introducing functionally segregated and autonomous balance sheets rather than one large complex one, separation could **expand the options** for resolving banking groups. Also, separation could **limit the scale of the task on an entity basis** and thereby make it more feasible to apply the different resolution tools. This could also allow a **swifter resolution process**, as it would be easier to identify problems and apply targeted solutions;
- It would give authorities the option of **treating different entities of the group in a separate way**. Different resolution strategies can be applied to different parts of the group;
- Separation could make it **easier to identify and assess losses** as they would either no longer be accounted for, or be accounted for in separate entities. This could e.g., make it possible to apply differentiated bail-in requirements, if appropriate, to the different parts of the group;
- Separation could also **improve market discipline** by ensuring that the losses arising from certain risky activities have to be borne solely by the creditors and investors of that entity, and not be diluted across the creditors and investors of the whole group. Those creditors and investors would accordingly have a greater interest in the risk that the entity is running, and creditors and investors in other less risky activities would be better protected.

5. TRADING AND CLEARING OF FINANCIAL INSTRUMENTS, INCLUDING DERIVATIVES

Market developments and experiences amid the crisis showed that the existing EU regulatory framework centred on trading activities on shares and on the operation of regulated markets needed updating. Regulation needed to address challenges posed by a more complex market reality and an increasing diversity in financial instruments and methods of trading. This was the basis for important regulatory interventions in this area, also in line with G20 commitments, such as the reviews of the Markets in Financial Instruments Directive (the "MiFID") and the Market Abuse Directive and the legislation on short selling and certain aspects of credit default swaps. Focusing on derivatives, these instruments have been growing significantly over the last decade. Derivatives markets today constitute a major part of some banks' investment banking activities. The failure of U.S. Lehman Brothers highlighted the size and interconnectedness of derivatives exposures and the difficulties to manage and orderly resolve counterparty risk. It also underlined the lack of transparency in derivatives market, which is mostly carried out in private over-the-counter ("OTC") venues rather than on public trading venues.

In order to limit contagion between banks from OTC derivatives positions, the European Market Infrastructure Regulation (the "EMIR") requires that, as of 2013, OTC derivatives must be collateralised and that standardised transactions be cleared by Central Counterparties ("CCPs") that interpose themselves between the parties and assume their counterparty risk. Moreover, the EMIR establishes trade repositories that will collect information on non-standardised derivatives, with the aim to increase transparency for regulators.

The MiFID review includes a proposal to require that all standardised derivatives be traded on trading venues, it introduces transparency requirements for non-equities, including

derivatives and strengthens powers of supervisors, including in the area of commodity derivatives.

The increased use of CCPs and higher collateralisation of derivatives rights and obligations will limit the risk of contagion. The cost of OTC derivatives will increase as a result of counterparty requirements to better internalise the associated risk. This may contribute to reducing the growth of the balance sheet of those EU banks that are significant users and/or providers (i.e., dealers) of derivatives.

Structural reforms could still complement these by **reducing the extent to which depositors are exposed to counterparty risks**. Moreover, multilateral clearing on CCPs will only apply to those derivatives that are sufficiently standardised.⁵⁸ The remaining ones will be subject to an enhanced bilateral clearing process (e.g., higher collateral requirements).

Furthermore, the MiFID review includes a measure that would provide for an organisational separation between a bank dealing-on-own-account business and the operation of a trading venue. While this will address one instance of conflicts of interest (the MiFID II is focussed on protecting market integrity and investors and is not intended to deal with issues concerning the setting-up of different legal entities for the provision of different services or activities) it will not require separate subsidiaries with stand-alone capital. Neither does it deal with the separation of traditional banking activities (e.g., deposit taking and lending) from the provision of investment services and activities. It is accordingly unlikely to affect intra-group subsidies.

Structural separation could complement this provision by requiring that certain forms of trading activity would have to be located in a separately capitalised and funded entity.

6. TAXATION OF FINANCIAL TRANSACTIONS

The Commission initially proposed a Financial Transaction Tax (the "FTT") to be implemented by all 27 Member States by September 2011. However, following discussions in the Council, it became clear that unanimous support for such a tax would not be reached. In October 2012, following a request from 11 Member States⁵⁹, the Commission proposed a decision to allow enhanced cooperation on the FTT. After an agreement had been reached between the European Parliament and the Council, the Commission put forward a detailed proposal for a FTT in February 2013.

The objective of the FTT is to: (i) tackle fragmentation of the Single Market that an uncoordinated patchwork of national financial transaction taxes would create; (ii) ensure that the financial sector makes a fair and substantial contribution to public finances; and, (iii)

⁵⁸ According to the FSB, the extent of CCP clearing varies according to segment. For example, for interest rate swaps, where CCPs have existed since quite some time, estimates of activity by the G15 dealers indicate that, as of end-February 2013 around 50% of these dealers' gross notional outstandings where CCPs active had been centrally cleared. For OTC credit derivative products the corresponding figure for all market participants was around 30% of the total notional outstandings. Central clearing of OTC commodity, equity and FX derivatives is yet to be well established at a global level. FSB (2013), *OTC Derivatives Market Reform: Fifth Progress Report*, April 2013.

⁵⁹ Belgium, Germany, Estonia, Greece, Spain, France, Italy, Austria, Portugal, Slovenia and Slovakia

create disincentives for financial transactions that do not contribute to the efficiency of financial markets or to the real economy.

The base for the FTT is broad, covering all transactions carried out by financial institutions on all financial instruments and markets that have an economic link to the FTT-zone. While the FTT base is broad, the tax rates are low.⁶⁰ Even so; the FTT would have to be paid by each financial institution involved in the transaction.

If adopted in current form, the FTT could have a significant impact on the cost base of some of the risky activities that are being considered for separation. These activities could accordingly be expected to decrease in importance. For example, the impact assessment accompanying the FTT foresees a significant reduction in derivatives activity, albeit with a strong degree of uncertainty. The FTT would in that case achieve one of the objectives of this exercise, namely to reduce incentives to engage in excess trading activity at the expense of real economy activities.

However, the FTT is at an early stage of negotiations and the contours let alone detailed specifics of the proposal are far from settled. Second, even if adopted, the FTT would only apply to banks incorporated in the FTT zone. This excludes banks incorporated in some of the major EU financial centres, which would make it susceptible to circumvention by means of relocation.⁶¹

Nevertheless, given the significant impact of the FTT on transaction costs, banks would have strong incentives to find a way around the safeguards.

Accordingly, bank structural reform applicable to EU28 could provide an additional safeguard to the FTT and limit regulatory arbitrage.

7. SHADOW BANKING

Structural reform of banks may trigger a migration of activities away from the regulated banking sector to the unregulated or less regulated "shadow banking sector", i.e., institutions of different kinds that provide services similar to the core banking functions (e.g., liquidity transformation and lending) thereby falling outside the scope of application of the EU banking prudential rules which can increase systemic risk and lead to financial stability issues. Although, when risks move to a less regulated sphere and out of the scope of the

⁶⁰ 0.1% for shares and bonds, units of collective investment funds, money market instruments, repurchase agreements and securities lending agreements, and 0.01% for derivative products.

⁶¹ The FTT proposal contains two safeguards against relocation of financial transactions. The first is the "residence principle", where who is party to the transaction is what counts, not where it takes place. If a financial institution involved in the transaction is established in the FTT zone, or is acting on behalf of a party established in this zone, then the transaction will be taxed, regardless of where it takes place in the world. To further prevent avoidance of the tax, the Commission has added to this proposal the "issuance principle". This means that a transaction will also be taxed, whenever and wherever it takes place, if it involves financial instruments issued in one of the participating Member States.

supervisors' screen it is also the case that the activity would no longer benefit from the implicit public safety net.⁶²

In pursuing structural reform, policymakers therefore need to be vigilant to avoid that much of the regulated activities migrate elsewhere. Banks may actually invest in products provided by shadow banking entities or even acquire some of these alternative institutions providing credit intermediation functions.⁶³

Accordingly structural reform would create a need for parallel regulatory actions in order to address a potential risk of regulatory arbitrage.

This would particularly be the case if some trading activities were to be isolated in a separate entity within a banking group. In this case, they should remain covered by high prudential standards and appropriate supervisory arrangements. The status of such "trading entities" should normally be the one of "investment firm" subject to the MiFID and to the relevant prudential requirements of the CRDIV/CRR. Unless these entities are controlled, the overall net reduction of risk could be limited. [Also a strict ban on proprietary trading may require stricter prudential requirements such as, for example, stricter exposure limits between deposit taking institutions and "shadow banks".]

Structural reforms only offer an incomplete response to the above, and needs to be completed by rules addressing risks posed by the potential increase of shadow banking.

The Commission's strategy so far has been to try and tackle all financial risks in a global and comprehensive way and by ensuring that the positive effects expected from the strengthening of supervision of financial players and markets are not neutralised by a transfer of financial risks towards less regulated sectors. This strategy has been articulated in the Commission's Green Paper on shadow banking published in March 2012⁶⁴. The overall concern regarding shadow banking is also shared by G20 leaders which have mandated the Financial Stability Board⁶⁵ to prepare policy recommendations on the topic.

Following the public consultation on the Commission's Green Paper, the Commission now intends to set out its roadmap in a communication. This Communication will comprehensively set out the issues at stake in relation to the shadow banking system and outline the priorities for a Commission initiative such as: (i) increasing the transparency of the shadow banking sector; (ii) adopting a harmonised framework for money market funds; (iii) developing securities law to further address risks associated with securities financing transactions (i.e., securities lending and repurchase transactions); (iv) strengthening

⁶² A parallel with the leverage ratios of hedge funds vs. banks is interesting in that respect. Banks typically operate with a higher leverage than hedge funds, which is only tolerated by investors due to the fact that the bank has a core of safe, stable deposit funding that is subject to explicit government guarantees.

⁶³ As put by the Federal Reserve Bank of New York in a 2010 shadow banking paper: "*Time and again, history shows that activities regulated out of banks, or financial innovations conducted and embodied by non-bank financial specialists (such as money-market mutual funds or finance companies) that pose a threat to the profitability of essential bank functions, are later acquired by banks – what's "regulated and innovated out" is usually "acquired back in".*" ("Shadow Banking", July 2010).

⁶⁴ http://ec.europa.eu/internal_market/bank/docs/shadow/green-paper_en.pdf

⁶⁵ G20 communiqué following the Cannes summit, November 2011.

provisions for interactions between shadow banking and banks including consolidation of activities which could be moved outside the banking sector; (v) identifying bank-like activities which may be provided outside the regulated sector; and (vi) providing for supervision arrangements to ensure that specific risks are adequately addressed.

As the shadow banking sector changes over time certain areas will require further and continuous analysis, particularly on the basis of the analyses of the Commission services and the G20 final recommendations.

8. CONCLUSION

The on-going banking regulatory reform agenda is of vital importance. It will significantly increase the resilience of both individual banks and the banking sector as a whole. Steps have been taken to address systemic risks and an EU resolution framework will soon be in place.

Current and on-going reform measures are intended to improve financial stability and provide a more robust base for economic growth and a well-functioning Single Market for financial services. Measures such as increased bank capital requirements, improved bank regulation and supervision will all help to avoid excessive risk-taking of banks.

However, the current reforms do not directly address the problems and distorted incentives that originate in the implicit public safety net, banks' complexity and interconnectedness. Structural reform would therefore be an important complement to on-going regulatory reforms, as it would offer one way of more directly addressing intra-group complexity, intra-group subsidies, and excessive risk-taking incentives. It also targets a broader set of objectives, such as ensuring that the deposit taking bank is not unduly influenced by a short term oriented trading culture and prone to conflicts of interest at the detriment of its customers.

ANNEX A4.1: IMPLICIT SUBSIDIES: DRIVERS, DISTORTIONS, AND EMPIRICAL EVIDENCE

1. INTRODUCTION

In a perfectly competitive market, inefficient companies or firms may fail and exit the market. However, in the banking sector, profits are often claimed to be privatised while losses are socialised as governments have often intervened to avoid bank failures. In order to prevent widespread failure, governments have been designing bail-out programmes for banks across the globe. The recent financial crisis has shown that policymakers are prone to do so particularly in order to bail-out large or otherwise important banks. These institutions deemed to be systemically important are typically referred to as too-big-to-fail ("TBTf"). Anticipating public support for these institutions, bondholders and depositors are willing to lower their requested return on these banks' liabilities. Therefore, these banks benefit from a lower funding cost. These benefits may stem from explicit government measures, such as deposit guarantee schemes (to the extent they are inadequately priced) as well as from the expectation that certain holders of banks' debt would not face the (full) risk of loss an explicit safety net ("implicit subsidy"). While the government safety nets can contribute to the prevention of systemic crises, they also have several adverse effects. In addition to the direct impact of imposing strains on public finances, they also lead to several market distortions. By making banking losses social, implicit subsidies lead to moral hazard as the market has a significantly reduced incentive to monitor banks' activities resulting in excessive risk-taking. Also, they distort the level playing field across large and small banks (as large banks are more likely to benefit from the funding cost advantage) and between banks headquartered in sovereigns with different ability to provide such support (depending on the state of their public finances). The implicit subsidy also leads to allocative inefficiency as it makes the financial sector more lucrative thereby luring resources from other sectors. The first part of the Annex explores these issues and explains the motivation for public intervention in banking as well as the side effects of the implicit subsidies.

In the second part of this Annex, we review the empirical evidence on the quantification of implicit subsidies. There has been significant interest by academics and policymakers on "putting a figure" on the size of the implicit government guarantee to the banking sector. By definition, the implicit subsidy is not transparent, and therefore not observable and not easy to estimate with great precision. There have been several strands of literature on the valuation of the implicit subsidy, including the funding advantage models, the contingent claims model, event study methodology, and by measuring market distortions. Empirical analyses typically confirm that implicit subsidies exist and in most cases are very significant, with subsidies reaching levels of several billion euros annually that represent a significant share of banks' profitability. However, the precise estimate of the level of the implicit subsidies is highly dependent on the exact methodology used, as well as on the sample period and countries under consideration. A summary table of the methodology and results of empirical papers is provided in Appendix A of this Annex. The Joint Research Centre (JRC) has also performed an in-depth empirical analysis based on the funding advantage model (rating methodology) in order to determine the size of the implicit subsidies and to find its main determinants, which is provided in Annex A4.2 (and is briefly discussed below).

2. IMPLICIT SUBSIDIES: DRIVERS AND DISTORTIONS

2.1. Why do governments intervene?

Deposit-taking banks are vulnerable to bank runs given their asset maturity transformation role. Their mix of illiquid assets and liquid liabilities (deposits that may be withdrawn at any time) may give rise to self-fulfilling confidence crises and force banks to liquidate illiquid long term assets at a loss even when they are, in reality, solvent (as explained in the seminal paper by Diamond and Dybvig (1983)). The stakes from bank runs are even larger as very often a bank run may have a contagion effect, given that banks are interconnected. If a large bank fails then other banks that rely upon this bank and its creditors to fulfil their obligations may collapse as well, and so on.⁶⁶ By creating a domino effect (through a direct contagion effect but also indirectly due to reputational or informational contagion), the failure of a TBTF bank threatens to adversely affect the real economy. A TBTF bank would receive support if the regulatory authorities consider that its failure could impose severe negative externalities upon society at large. Anticipating government interventions, depositors are less likely to run on banks. Therefore, ensuring depositor confidence may help prevent wide-scale collapse of the banking sector and facilitates banks' ability to engage in effective maturity transformation. Also, when banks fail the information capital they have developed may disappear resulting in many borrowers not having access to funds to pursue productive investment opportunities. As a result of the above, widespread banking crises significantly affect the economy's ability to channel funds to productive investment opportunities, possibly leading to a full-scale economic crisis and a large decline in investment and output.⁶⁷ In order to address these social costs of financial crises there are public safety nets measures to restore depositor confidence. These measures include deposit insurance, lender of last resort facilities (discount window central banks role) and government bailout of these institutions.

These explicit and implicit public safety nets allow banks to enjoy significant benefits, as their funding costs are artificially lowered given that creditors take into account the lower credit risk. Explicit deposit insurance measures have been introduced since the 1929 Great Depression and now they exist in more than 90 countries worldwide. In July 2010, following concerns about some Member States' banking sectors, the level of deposit protection in the EU increased from a minimum of EUR 20 000 to a uniform level of EUR 100 000, with a maximum pay-out delay of 7 days. In addition to these explicit guarantees, policymakers will be inclined to bail-out institutions that are considered to be systemically important and therefore whose potential failure could threaten the stability of the entire financial system. There is an expectation from the market participants that the government might step in and bail-out at least some stakeholders. For example, in several cases during the recent financial crisis, bondholders did not face the (full) risk of loss, even if equity holdings were diluted. Consequently, these banks may in turn enjoy favourable treatment from market participants exploiting these safety nets. While for explicit subsidies it is possible for governments to recoup the cost of intervention by levying a charge for it (or at least for a great part of it), for

⁶⁶ One should distinguish the systemic importance of an institution with its size. While many systemically important financial institutions (SIFIs) are systemically important by virtue of size, size is neither a sufficient nor a necessary conditions for a firm to be SIFI.

⁶⁷ Bankruptcy costs are very high for banks. Typically in bankruptcies the liabilities of the company are frozen while it business is operating in a way to maximize the resources available to creditors. However, a bank's liabilities are central to the value it creates and therefore this process is almost impossible for banks (see ICB (2011)).

implicit guarantees this is typically not possible. Therefore, to the extent they are not recouped, implicit subsidies are a transfer of resources from the government to the financial sector. Bank creditors, customers, staff, and shareholders may benefit at the expense of taxpayers.

2.2. What determines governments' decision to intervene and bail-out banks?

Concerning implicit subsidies, the authorities do not have any explicit ex ante commitment to intervene. Therefore, by definition, implicit subsidies are not ex ante transparent and market participants cannot know with certainty which institutions and which creditors the public authorities would bail-out. Instead, when referring to implicit subsidies, it is useful to think about the bail-out as a probabilistic event (that is, assigning a probability that some institutions' creditors will be subject to a bail-out).

Stern and Feldman (2004) consider that there are three motivations for policymakers to engage in TBTF policies. Firstly, public authorities worry about the system-wide consequences of bank failures and therefore act in the public interest. Secondly, regulators and supervisors may have incentives that differ from the public. For example, they might bail-out banks to avoid looking bad in case of bank runs, or to preserve prospective career opportunities in banks for supervisors. Thirdly, public authorities may want to direct credit: protecting large banks that are often government-controlled helps encourage the public to put their savings in the institutions, giving them resources to lend according to the government's wishes. They also acknowledge that during a financial crisis it is inevitable that some decisions are made as new information emerges, and it is easier for policymakers to err on the side of caution. That is, if policymakers bail-out a bank at risk, they would risk wasting taxpayer money and provoking public outrage. If, though, policymakers wrongly do not intervene, then the whole financial system may collapse (with consequences for the real economy).

López-Espinosa et al (2013) analyse a large sample of banks operating in 24 countries and investigate whether firm-specific characteristics affect the likelihood of recapitalisation and the volume of these capitalisations. They find that banks' sources of funding, management quality, and the degree of international diversification help predict future fiscal liabilities. Leveraged banks relying on non-stable funding and fewer deposits, as well as banks with low management quality, and those more exposed to fair value securities, are more likely to require public capital. Similarly, a bank with domestic operations is more likely to be rescued, as national authorities are not likely to weigh to the same extent the global externalities from the disorderly failure of an internationally-active bank.

Credit rating agencies (CRAs) also assess the likelihood of government intervention. For example, Moody's (2011) explains that the availability of support will reflect the sovereign's willingness to provide public funds and its ability to intervene. Governments will be more willing to intervene if banks have a greater systemic importance, and will depend on the extent and type of resources required to prevent failure, and the availability of alternative policy instruments (such as resolution mechanisms). A government's ability to intervene will depend on the government's debt rating. Also, the more widespread the problems in the banking sector are, the less likely that governments would be in a position to intervene.

2.3. Side effects of implicit (and explicit) guarantees

To the extent that they are under-priced there are budgetary implications from the implicit (and explicit) subsidies, as well as market distortions due to this implicit guarantee, which tend to create efficiency costs in the economy. Morrison (2011) argues that the most important costs of the TBTF problem are incurred ex ante, in the form of distorted incentives that arise as a consequence of distortions to the capital markets, and to the choice of banks' scale and scope.

1. *Negative impact on taxpayers and public finance of ex post bail-out*

As explained above, implicit subsidies are probabilistic events (that is one cannot anticipate with certainty which institutions and under which conditions governments will intervene). Sometimes bail-outs (of at least some categories of creditors) arise as governments intervene to avoid a devastating impact on real economic activity. Governments are very reluctant to let large and interconnected banks fail given the high potential costs, or if they do they would like to bail-out some categories of creditors. For example in the 1984 Continental Illinois case in the US the government also guaranteed all accounts (even if the deposit insurance was limited to a fixed amount) and prevented losses for the banks' bondholders. As shown by the recent financial crisis, governments have stepped in in several cases with significant exposure for taxpayers. For the UK alone, Morrison (2011) estimates taxpayer exposure to banking sector losses at GBP 955 billion, and taxpayers' paper loss on RBS and Lloyds shares at around GBP 12.5 billion. This UK example illustrates that implicit subsidies, at some point, become explicit, and divert resources from the public budget which might have greater added value to the society.

Furthermore, the massive scale of the adopted public recapitalisation measures, while succeeding in some cases in preventing the collapse of the financial sector, has magnified spillover effects from banking institutions to sovereigns. Negative feedback loops in banking and sovereign balance sheets have been observed as massive public interventions lead to higher sovereign risk, which in turn negatively affects banks (for example, through their exposure to their sovereign bond risk). Acharya et al (2010) find that sovereigns that announced bank bail-out programmes during the financial crisis had a substantial increase in market perception of their default risk, measured by the price of the credit default swaps (CDS). Also, the close link between banks and sovereigns is confirmed by the high correlation in the subsequent movements in CDS prices for sovereigns and large banks.

Therefore, public bail-out can impose significant financial burden on taxpayers in the form of direct funding costs, greater costs of sovereign borrowing, and inefficient allocations of public finances.

2. *Moral hazard and excessive risk*

From a theoretical perspective, the impact of bail-out expectations on bank risk-taking is ambiguous. On the one hand, excessive risk-taking on behalf of bank managers and personnel would arise as a result of the market discipline hypothesis. According to this hypothesis, due to the expectation that unsecured depositors, bondholders, and even shareholders might be bailed-out, they would have a reduced incentive to monitor the bank's activities closely and ask for a higher premium if the bank is taking too much risk. Risk-shifting may occur if deposit insurance is not fairly priced (Merton, 1977), or if governments provide guarantees to

holders of bank debt (Flannery and Sorescu, 1996). This increased moral hazard arises with any safety net or insurance that is under-priced (see Freixas et al (2004)). Furthermore, an adverse feedback loop exists, as implicit subsidies lead to higher risk-taking, which in turn increases the likelihood of implicit subsidies and further increases the level of implicit subsidies. For example, Kane (2009) relates the market's appetite for structured securitisation to the implicit safety net and supervisory cover provided to the sponsors of these products. Similarly, Blundell-Wignall et al (2009) suggest that the TBTF problem is also the result of the excessive growth through derivatives and structured products trading, which present significant risks.⁶⁸ On the other hand, under the charter value hypothesis, government support decreases banks' funding costs with depositors and creditors demanding lower rates. The decline in funding costs increases the interest margin and raises banks' charter values, which leads to banks taking fewer risks to protect future rents (Keeley, 1990). Therefore, according to this latter hypothesis, implicit subsidies and the threat of losing future rents act as a deterrent of risk-taking.

Empirical evidence, however, provides support to the market discipline hypothesis. Marques, Correa and Saprizza (2013) find that the intensity of government support is positively related to bank risk-taking, using an international sample of bank data and government support for 2003-2004 and 2009-2010. They also show that this relationship is stronger in 2009-2010 compared to 2003-2004. Acharya, Anginer and Warburton (2013)'s findings from a large US sample also provide support for the market discipline hypothesis. They show that for institutions that achieve systemically important status, bond spreads are less sensitive to risk as the bond spread-risk relationship diminishes with TBTF status. They also find that larger financial institutions follow riskier strategies than smaller ones. Gropp et al (2010a) find evidence that public guarantees may be associated with substantial moral hazard effects. They use the removal of government guarantees by court decision in 2001 for savings banks in Germany as a natural experiment on the effect of public guarantees. They show that when these guarantees were removed, those banks' credit risk reduced, as they cut the riskiest borrowers from credit (with the Z-score of average borrowers increasing by 7.5%). Banks also increased interest rates on remaining borrowers (by around 46 basis points), and banks' bond yield spreads increased by 5 basis points. They conclude that "a credible removal of guarantees will be essential in reducing the risk of potential future financial instability."⁶⁹ Dam and Koetter (2012) also explore German data of actual bail-outs and official records of distress during 1995-2006 and show that significant increases in expectations of bail-outs for banks (measured through political factors and historical bailout probabilities) lead to significant increases in risk-taking.

Furthermore, Gropp et al (2010b) argue that there is a third effect (in addition to the market discipline and charter value), as government guarantees may also affect the risk-taking of, not only, the protected banks but also, through competition, of the protected banks' competitors. This indirect effect arises as government subsidies reduce the profit margins of competitor

⁶⁸ Such assets valued at fair value are likely to be extremely volatile in a crisis and can eventually wipe out the capital of the whole group. Securities business sharing capital with commercial banking creates a contagion risk as the highly volatile securities business shares capital with the less volatile commercial bank where cost amortisation accounting applies. They conclude that removing TBTF problems will not be credible if it is clear to investors that contagion risk is present.

⁶⁹ They also find that there is an increase in the yield spread of saving banks' bonds after the announcement of the court decision to remove guarantees (from 45 to 51 basis points) and savings banks adjusted their liabilities away from risk-sensitive debt instruments, and towards insured deposits and equity.

banks, due to fiercer competition from banks that are able to refinance at subsidised levels. This leads to greater risk-taking of the competitor banks. Gropp et al (2010b) find evidence from a sample of banks from OECD countries that the main channel of increased risk-taking is through increasingly risky competitive conduct of other banks. They conclude that bail-out policies increase market expectations of bail-outs in the future, which may distort competition and increase risk-taking of all banks, and lead to greater financial instability in the future.

There is some empirical evidence that structural reform can address excessive risk-taking. For example, Marques, Correa and Sapriza (2013) find that capital supervision and regulation were not enough to fully prevent additional risk-taking by banks with more government support, but banks that faced more restrictions in terms of activities they were allowed to perform were less likely to take on more risk (see also Blundell-Wignall et al. (2009)). Besides, in order to curtail the excessive risk-taking and expansion of banks resulting from the existence of public safety nets in the US, when the first safety nets were introduced, they were accompanied by a series of regulations that (i) prohibit deposit-taking banks to underwrite or deal in securities, (ii) limit commercial banks' access to deposit insurance, as well as (iii) set a saving deposit rate ceiling to avoid destabilising competition among banks.

3. Competitive advantage for banks that benefit from the implicit subsidy.

There is a competitive advantage for banks that benefit from the implicit subsidy in terms of lower funding costs. Banks, however, are likely to benefit from such an implicit subsidy to differing extents. Even if implicit subsidies are hard to estimate with great precision, there are several findings that are recurring in the literature. According to several studies, and as also confirmed by the JRC work, implicit subsidies benefit the largest banks disproportionately (see Rime (2005), Noss and Sowerbutts (2010), Schich and Lindh (2012) and Oxera (2011)) and therefore larger banks are more likely to benefit from such an implicit subsidy. This would entrench the too-big-to-fail banks, and induce a competitive barrier for smaller banks. Another common finding in the literature, also confirmed by JRC work, is that the implicit subsidy advantage is higher the greater the creditworthiness of the sovereign in which the bank is headquartered. Therefore, a level playing field across EU Member States is not guaranteed, as banks in Member States with higher sovereign rating benefit disproportionately more from such implicit subsidies. This distortion is likely to have become more acute as the debt crisis in several Member States reflects increasing disparities in the public finances across Member States.

4. Allocative inefficiency

Another source of distortion is an allocative (and productive and dynamic) inefficiency. The implicit subsidy makes the financial sector artificially more lucrative and this lead to increases in the size of the financial sector diverting resources (including human capital) from other sectors of the economy. Therefore, from a static perspective, banks that benefit from implicit subsidy due to lower cost of capital (funding costs) will be in a position to over-expand. Furthermore, if banks are more likely to be bailed-out if they are larger and more interconnected, as also confirmed by empirical analysis, then banks would have an incentive to increase both their scale and their exposures to other large banks. As a result, an institution to obtain or maintain its TBTF status would have an incentive to have an aggressive program of mergers and acquisitions and expand their activities' portfolio as much as possible, making the institutions even more gigantic, ever more complex (and thus harder to resolve) and more

politically influential. In addition to this TBTF bias, Kane (2009) suggests that implicit subsidies may further create geographic distortions in the financial market as financial firms have incentives to book risky positions in jurisdictions where supervisory loopholes would allow maximum benefits of subsidies.

Furthermore, there are productive and dynamic inefficiencies stemming from implicit subsidies. Stern and Feldman (2004) claim that the possibility of a bank bailout makes it more likely that banks will not operate in a cost efficient way and may also innovate less.

Also if public interventions take a specific form, such as in the form of bailing out debtors, they also create a distortion in the liability/equity structure of banks leading to sub-optimal levels of leverage (see Admati and Hellwig (2013)).

2.4. Why do governments still intervene if public intervention leads to high TBTF costs?

As explained above, implicit public interventions have very significant side effects. Despite these adverse effects, policy makers often bail-out failed banks. Stern and Feldman (2004) explain that the TBTF problem stem from a lack of credibility of policymakers' commitment to not bail-out large banks. This lack of credibility is another manifestation of the time inconsistency problem as discussed by Kydland and Prescott (1977). Even if policymakers recognise that bail-out policies lead to long run moral hazard and distortions, they face a commitment problem with respect to their pledge that they will not intervene in cases of bank crises. When a large bank is at the brink of failure, policymakers will want to renege on their pledge in order to avoid systemic risk. In turn unsecured creditors anticipating such policymakers' incentives will not monitor large banks sufficiently leading to such TBTF problem.

Besides, governments often like to leave some discretion on their hands on their decision to intervene or not in order to cater for unforeseen situations. Governments have often deliberately left an ambiguity on whether they will intervene and they do not announce their willingness to support institutions they consider TBTF. Even if this provides some short term comfort to policymakers it also accentuates the time inconsistency problem they face.

Furthermore, several academics claim that the incentives to intervene (and the associated implicit subsidy) are likely to persist even if a clear resolution mechanism is in place (see Admati and Hellwig (2013)). They argue that no bail-out commitments are not credible as banks' interconnectedness remains high and the (social) costs of a systemic crisis are also too high. Also credit rating agencies such as Moody's consider that when they assess the likelihood of public intervention they must strike a balance between "clear policy intent to impose losses on credits [...] and on the other hand, despite stated policy preferences, there are still cases where governments will feel bound, or trapped, by the complexity and interconnectedness of banks (and the painful economic repercussions that their failure will entail) to continue to extend systemic support to troubled institutions".⁷⁰

As other complementary policy initiatives, structural reform is a way to (at least to some extent) address this time inconsistency problem. By separating trading and deposit taking

⁷⁰ See Moody's Investors service (2011) "Status Report on Systemic Support Incorporated in Moody's Bank Debt Ratings Globally", Special Comment, page 2

activities it is made more credible that governments would not renege on their no bailout pledges for the trading entities. One would expect a lower probability of intervention for trading entities (for example due to the fact they will have access to deposits). Therefore, with less of an incentive for policymakers to renege on no bailout pledges then the TBTF problem would be (at least to some extent) reduced.

The complementarity of structural reform with other reform proposals, and in particular with resolution, is discussed in detail in Annex A3.

3. VALUING THE IMPLICIT GUARANTEE

There has been a lot of research on the quantification of the implicit government guarantee to the banking sector. Measuring the level of implicit subsidies is important to provide insight on the potential magnitude of their adverse impact (both for the taxpayers and in terms of distortions in the market place). The implicit subsidy is not transparent and therefore not observable and as a result it is hard to reach a consensus on its size. The recurrent finding in the literature is that implicit subsidies exist and are sizeable; with subsidies reaching levels of several billion euros annually for large banking groups. However, the precise estimate of the level of the implicit subsidies is highly dependent on the exact methodology used as well as on the sample period/countries under consideration, with estimates differing to a significant extent. There have been several strands of literature on the valuation of the implicit subsidy, including the funding advantage models, the contingent claims model, event study methodology, and measuring market distortions. Also, different studies on implicit subsidies focus either on bondholders, shareholders or depositors. Kane (2000) suggests that the first place to look for implicit subsidies is in markets for uninsured bank and bank-holding debt and indeed most literature focuses on the advantages of banks on their funding through debt. There is however a number of studies on equity benefits (typically through event studies) and some work on uninsured depositors (Jacewitz and Pogach (2013)).

In this section we first summarise the findings of the literature in the field of quantifying the implicit subsidies and identifying its determinants and discuss the methodologies used. We also discuss two studies of two large US banks. Before concluding we discuss the work undertaken by JRC. Appendix 1 summarises the findings of the literature and the methodology used in the literature.

1. *Funding advantage models*

In this class of papers the subsidy is valued as the aggregate reduction in the cost of bank funding following an implicit government guarantee. Implicitly there is a comparison with a higher counterfactual cost that the bank would face in the absence of this implicit government support. Then multiplying the difference between the actual and counterfactual cost of funding by the size of each bank's risk-sensitive liabilities gives an estimate of the implicit subsidy. However, this approach assumes that banks' liability structures are independent of the existence of the implicit government guarantee but in practice when government support is likely withdrawn banks might seek to reduce their more expensive liabilities/shrink. There are two main approaches within funding advantage models the size based approach and the rating based approach.

a. Size based approach

Size based models test the hypothesis that only large (TBTF) banks would be supported by governments and consequently enjoy a reduced cost of funding compared with their smaller counterparts. Consequently, these models assume that in the absence of government support large banks would face the same cost of funding as their smaller peers. A number of papers that follow this size based approach they use events to identify the implicit subsidies and examine how large (TBTF) banks funding costs diverge from the funding costs of small banks in the bond market.

A simple example of this approach is Baker and MacArthur (2009) that use US FDIC data for depository institutions and assume that all banks with assets in excess of \$100 billion (18 BHCs) will receive government support in the event of their failure. Using bailout events they find that larger banks have 49bps lower funding costs post such bailout events, which translates to a government subsidy of USD 34.1 billion a year for these 18 banks. Acharya, Anginer and Warburton (2013) find evidence that expectations of state support are embedded in credit spreads on bonds issued by more than 500 US financial institutions. They analyse the determinants of the bond spread by regressing them on a number of institution (including size and risk), bond, and macro characteristics. They consider that an institution is TBTF if it is in the top 90th percentile in terms of size. They find that the implicit subsidy provided large banks with an annual funding cost advantage of approximately 28 bps before the financial crisis increasing to 120 bps during the crisis. The total value of subsidy amounted to USD 20billion per year before crisis reaching USD 200billion during the crisis. They also examine events related to the recent financial crisis and study their impact in the bond market. Following the governments' rescue of Bear Stearns larger financial institutions experienced greater reductions in bond spreads than smaller institutions and following Lehman Brothers collapse larger financial institutions experienced greater increases in their spreads compared to smaller institutions. They also show that the passage of Dodd-Frank in the summer of 2010 did not eliminate investors' expectations of government support.

Similar to debt holders, uninsured depositors face a potential loss in the event of bank failure, and therefore should require less compensation for risk from a bank they feel will likely receive a bailout. Jacewitz and Pogach (2013) consider that since uninsured depositors face potential losses in the event of closure the market will ask a smaller risk premium of banks for which it considers a government bailout to be more likely. Their results confirm that largest banks receive a deposit premium. They estimate differences in the cost of funding using the actual deposit rates offered at the branch level between 2005 and 2008. They focus on the premium paid on USD 100 000 money market deposit accounts and use the USD 25 000 money market deposit accounts as a threshold to account for non-risk factors across banks (such as having a larger branch network, a broader range of services etc.). The advantage of using such a difference in difference approach is that they can eliminate many non-risk based bank characteristics as well as many standard risk metrics. They find that largest banks paid 15-40 bps lower than other banks for comparable deposits (deposits with at least USD 100 000). They estimate that if this advantage is extended to all consolidated uninsured funds of banks it would represent 70% of their pre-tax profits. They also show that this difference in risk premiums cannot be attributed to usual balance sheet measures of risk. They conclude that since large banks' risks are differentially priced, the competitive environment will tend to favour them.

The main advantage of the size based approach is that (at least in its simpler versions) it is relatively simple to estimate. However, the main drawback is that the size based approach makes the crude assumption that only large banks will receive government support. Furthermore the related question is at what level should this threshold apply, and why. A commonly used TBTF threshold in the literature is \$100billion in assets. But even ex post the history of the applications of bailouts makes a precise definition of a TBTF threshold impossible.⁷¹ These models also typically do not take into consideration that size alone may

⁷¹ For example Washington Mutual and Lehman Brothers with more than USD 300 billion and 600 billion assets respectively were not bailed out.

not be the only factor that determines whether a bank will get bailed out or not and other factors such as interconnectedness are important.

b. Rating based approach

Some credit rating agencies (including Fitch, Moody's and Standard and Poor's) often issue two credit ratings for a bank in their assessment of the probability of default: a stand-alone rating and a higher support (all-in) rating. The all-in rating factors in the agencies' estimate of the external support that the bank under consideration would receive from public authorities and parent companies while the former only considers the intrinsic strength of the bank. More recently credit rating agencies also publish adjusted stand-alone ratings that take into account also the likely parental support (adjusted stand-alone rating). As a result, the difference between the adjusted stand-alone and all-in ratings would reflect a decrease in the cost of servicing one's debt and is functionally equivalent to an implicit guarantee for the debt. This difference is often called "uplift". Several studies exploit the rating approach to determine the value of the implicit subsidy and/or to assess its determinants.

Studies find consistently several notches of uplift which translate into significant levels of implicit subsidy. The size of the implicit subsidy depends on the sample used as well as the definition used for rating sensitive liabilities, as only for these liabilities the funding advantage would apply. Haldane (2012) looks at 29 institutions deemed by FSB to be world's most systemically important. In pre-crisis the difference between the stand alone and support ratings averaged 1.3 notches using Moody's data (note that he uses stand-alone and not adjusted stand-alone ratings). He argues that even small notches can translate into big implicit subsidies if balance sheets are large. He estimates the implicit subsidies to be on average around USD 70 billion per year for 2002-2007 (which corresponds to roughly 50% of the average post-tax profits of these banks). By 2009, the ratings uplift reached 3 notches and the average implied subsidy exploded to over USD 700 billion per year. Schich and Lindh (2012) also estimate the rating uplift using Moody's data focusing on a sample of 118 large European banks between 2007 until March 2012. They also find that the implicit guarantee increased in the wake of the global financial crisis (uplift of around 2.2 points in 2007 and 2012 which peaked in 2009 to 3.14 points). In March 2012 the estimated yearly reduction in funding costs were around USD 35 billion in Germany, around USD 15 billion in France and USD 10 billion in the UK. Bijlsma and Mocking (2013) using data from Moody's on 151 relatively large European banks show that the size of the implicit subsidy reached almost EUR 150 billion for the sample of these banks in mid-2011 to fall to around EUR 100 billion at July 2012. Ueda and di Mauro (2012) use Fitch data on around 900 banks from 16 OECD countries and find a funding advantage of around 60bp in 2007 and 80bp in 2009.

Several papers also attempt to identify the source of determinants of credit rating uplifts by regressing the uplifts on several bank and other relevant characteristics (such as variables relating to the rating of sovereigns in which banks are headquartered). Schich and Lindh (2012) use cross section analysis for March 2012 with country fixed effects to control for unobserved heterogeneity across countries. Their results show that larger firms receive (on average) larger such subsidy implicit guarantees and implicit subsidies are higher the larger the bank relative to its peers in the same country. Estrella and Schich (2012) follow a similar approach but focus on the effect of government rating on the uplift. They find that the higher the sovereign rating the higher the uplift. A 2 notch increase/decrease in sovereign/stand-alone rating leads to 1 notch uplift. Rime (2005) finds that bank size has a positive and

significant impact on all-in rating and such impact is larger for banks with low individual ratings.

JRC has also undertaken an empirical work on implicit subsidies based on the ratings approach which is discussed below. The full analysis is provided in Annex A4.2.

An advantage of the rating approach is that it controls for the relative risk of different banks' business models (as incorporated in the ratings). Also it allows taking into account the likelihood of receiving government support as agencies typically distinguish between stand alone and support ratings. However, the ratings based approach has been criticised due to reliance on subjective rating agency judgment and to be informative it requires that credit rating agencies have good insight of banks' risks and the probability of government support. For example, Goldman Sacks (2013) considers that the link between credit ratings and funding costs may not be as clear as ratings take a different time horizon giving more long term view of credit fundamentals and typically lag market assessments. However, even if subjective it would be hard to argue that credit ratings are not informative. Credit rating agencies are important market participants and markets use credit ratings in pricing debt instruments. Therefore while subjective their views are likely to reflect market sentiment and views on the likelihood of government support. Currently all three major credit rating agencies provide proxies for government support.⁷² Furthermore, there is some evidence that ratings of credit agencies have predictive power. Marques, Correa and Sapriza (2013) also investigate whether the Moody's support ratings are able to predict actual bail-outs. They find that banks that enjoyed a nonnegative support rating were more likely to be rescued in 2008-2010 by 30 percentage points.

2. *Contingent claims ("CC") models*

Contingent claims models determine the implicit subsidy in an option pricing framework. The value of the subsidy is seen as the expected annual payment from the government to the banking system necessary to prevent default. The subsidy is modelled as the shortfall between the value of banks' assets and some threshold based on their minimum capital requirements at some future time (for example Oxera (2011) uses a one year horizon). Failure is assumed to arise when total assets of all banks falls below this minimum requirement. The value of government support is assumed to be the sum necessary to restore the value of assets to this minimum amount, weighted by the probability of their falling below that level.

CC models require the modelling of the dynamics of banks' future asset values and their statistical distribution. This is similar to pricing an option with the banking system viewed as a residual claimant on the government. The value of the implicit subsidy is similar to a put option. If banks' assets are greater than the threshold minimum asset value when the option expires then it would not be exercised. If the value of the assets is below the trigger point its payoff is equal to the difference between the two. There are two possible methods to model the dynamics and distribution of future assets: the equity option price approach in which the

⁷² For example Moody's (2011) explains the methodology underpinning the assessment of support which is based on the willingness to provide support, the capacity of a sovereign to do so and the workability of overall resolution regimes.

distribution of bank's equity values is estimated based on the prices of equity options and the historical approach which bases its estimates on historical prices of bank equity).

Oxera (2011) uses an equity option price approach. Equity options pay out if banks' equity experiences price changes of different magnitude and they give an insight into investors' expectations of relative likelihood of changes of different magnitudes in banks' equity prices. The central base case estimate of the forward looking state support corresponds to overall GBP5.9 billion annual transfers for 2010 in the UK for the five largest banks. However, as Noss and Sowerbutts (2012) notes, the conclusions are sensitive to a number of assumptions. For example, the timing of state intervention; the implicit subsidy is modelled as the expected shortfall at a horizon of one year (European option i.e. at year-end). But state support could be extended at any time were the value of banks assets to fall below the threshold. Noss and Sowerbutts (2012) suggest that it would be more realistic to consider the subsidy as a look back option whose value is determined by maximum shortfall at any time over a year's horizon (subsidy would rise to GBP30billion). Other critical assumptions include the level of the discount factor, flatter tail distribution of asset returns. Overall, the subsidy can reach up to GBP120 billion under some assumptions. Under a historical approach the estimated subsidy is lower at around GBP 30 billion Noss and Sowerbutts (2012). Therefore estimates for the same period and banks range from GBP5.9 billion to GBP120billion depending on the underlying assumptions.

Noss and Sowerbutts (2012) note further drawbacks of these models. They note that CC models require modelling of the future path of banks' assets and make simplifying assumptions (for example that banks fail when assets fall to a value commensurate with banks' minimum capital ratio). Also they consider that banks' equity prices may be distorted by investor's expectation of support, increasing their value and thereby reducing the size of the estimated subsidy.

On the other hand, an advantage of the CC models is the use of market price data. Oxera (2011) for example claims that market prices should reflect aggregate expectations of actual investors in the market and are available almost continuously. In this respect, CC models are able to estimate directly the expected value transfer from government based on likelihood of a systemic shock occurring and expected payment from state to avoid systemic failure. On the contrary, funding cost advantage models look at difference with and without support, albeit often it is not obvious how to establish the relevant counterfactual.

3. Event studies

Another stream of literature looks at how specific events such as policy announcements related to TBTF policy or policy interventions, as well as bank mergers affect market expectations on the implicit subsidies by studying banks' equity prices. These of papers on event studies have looked at equity prices of banks rather than debt prices. Equity holders may benefit from implicit subsidies either due to an expectation of bail-out as well as from an indirect effect as implicit subsidies will impact a bank's stock price by reducing a bank's cost of funding thereby increasing its profitability.

A number of papers explore the impact of events that affect market's expectations concerning TBTF policy. For example, O'Hara and Shaw (1990) conduct an event study to estimate the value of TBTF subsidy using the 1984 congressional testimony from the US Comptroller of the Currency in which he indicated that the 11 largest US banks were subject to a TBTF

policy (whereby for these banks total deposit insurance would be provided). They find that there was a significant positive average residual return of 1.3% in these banks' equity value on the day of the announcement. Pop and Pop (2009) find evidence that the announcement that shareholders would not incur losses in the 2003 Resona Holdings bailout in Japan resulted in significant abnormal returns on the larger Japanese banks.

Other studies instead examine the impact of mergers on public expectations of TBTF. The underlying idea is that when two banks merge and as a result they become TBTF (or increase their likelihood of being TBTF) they would earn a premium compared to other mergers. In particular, any merger that strengthens market presumptions that a bank acquirer is TBTF would lower that entity's financing cost and this may be reflected as a benefit for shareholders. Kane (2000) studies the mergers of the top 12 US banks between 1991 and 1998 and finds that they gave greater value to shareholders when the target was a deposit-taking institution which was large. He considers that implicit subsidies have inflated incentives for giant banks to merge with other banks and this way shift risk into taxpayers. Brewer and Jagtiani (2011) use data from 1991-2004 to look for the premium paid in 8 US mergers that bought organisation over USD 100 billion in assets in the US (their defined threshold for TBTF), in order to test the hypothesis that banks are willing to pay more to become TBTF. They find that acquirers paid a total premium of around USD 15 billion. Molyneux et al (2010)' results are similar for nine EU countries with EU banks paying higher merger premiums if their targets are larger. Penas and Unal (2004) study the impact of 66 US mergers. They find that mergers that push the combined bank's asset size above the TBTF threshold asset size (2% of assets of all depository institutions) realise the highest returns whereas returns of megamergers (mergers among banks that are already TBTF) or smaller bank mergers (that do not bring the combined entity above the TBTF threshold) earn relatively lower adjusted returns. This can be explained as megabanks are already TBTF while small banks do not become TBTF as a result of the merger. These "medium mergers", which are most beneficial for shareholders, are found to benefit from a funding cost advantage as they lead to a 15 basis point decrease in credit spreads of new debt issues of the acquiring bank post-merger.⁷³ On the other hand, a study that does not find evidence of TBTF subsidy is Benston, Hunter and Wall (1995) which analyse the prices that acquirers bid in an earlier US sample, 1980-1989. They conclude that most of mergers in the 1980s were motivated by earnings diversification rather than TBTF considerations.

A caveat of event studies based on share prices is to ensure that the events under consideration are truly exogenous and therefore are not reflected in these prices pre-announcement (of the intervention or the merger). To the extent that the studied event is not exogenous the analysis would not be in a position to identify the claimed effect. An additional caveat of these studies is that they can only identify the market price changes and not the level of such implicit subsidies as the banks in question may have been benefiting from the implicit subsidy even before the examined event. Thereby these studies are likely to provide a lower bound for the size of the implicit subsidies. On the other hand, some studies do not adequately control for the efficiency effects of mergers and therefore any identified impact may confound both market power/efficiency and TBTF considerations (as in Kane (2000)) thereby possibly overestimating the TBTF effect. Similar to the size based funding

⁷³ They also find that both target and acquiring bank bond returns record a positive cumulative adjusted return (of 4.3 and 1.2% respectively).

cost models, a problem inherent in several of these studies is the need to make an assumption on the TBTF threshold.

4. Distortions of market prices – CDS prices

Another approach to measure the size of the implicit subsidy is to analyse the distortions of market prices caused by the TBTF policy as reflected in the CDS market. The underlying idea is that the implicit subsidy would lower the CDS spreads for these banks as the default probability would be lower.

Völz and Wedow (2011) analyse an international sample of banks and find that CDS prices tend to be distorted if the banks are larger and therefore less market discipline is exercised on these larger banks. A one percentage increase in mean size of a bank relative to the country's GDP reduces the CDS spread by around 2 basis points. They also find that this relationship has decreasing returns as banks would presumably become too big to save (with the turning point located at around 2 times the home country's GDP). Schweikhard and Tsesmelidakis (2012) consider that there is an asymmetric treatment of debt and equity during bailouts which tend to favour creditors, as typically equity holders are the first to be hit. In order to exploit this asymmetry, they compare credit default swap (CDS) premiums to their theoretical equity counterparts for around 500 US companies between 2003-2009. They find that while CDS and stock-market-implied CDS spreads are closely aligned during the pre-crisis period, during the 2007-2009 crisis the stock-market-implied CDS prices for banks are significantly higher than market CDS prices (that is there is higher stock-implied default risk compared to CDS observations). This difference is also shown to be positively related to the size of the banks and by revaluing the offering price of bonds in the US they estimate the total subsidies to amount to around USD 130 billion over the period 2008-2009.

Industry studies

There are some studies from the industry that claim the TBTF banks do not actually enjoy a funding advantage due to the implicit subsidy.

Goldman Sachs (2013) for example argues that while a small funding advantage was present during the financial crisis it has totally disappeared post crisis. The funding advantage for US has been modest, around 30 bps on average since 1999.⁷⁴ They claim that large firms in other industries also benefit from a comparable or even larger funding advantage, which suggests that size confers benefits that appear distinct from the issue of government support. In addition, they find that bonds of the largest banks provide investors with far greater liquidity and this added liquidity which, coupled with the superior loss history for large banks, can explain the funding advantage that the largest banks have experienced. In other words, investors are willing to pay for the benefits of liquidity and large banks have more liquid bonds. They make a second point that the largest banks generate fewer realised losses than do the failures of smaller banks per dollar of deposits. They provide the example of the Troubled Asset Relief Program (TARP) in which the government made a 15% profit on the assistance it provided to the six largest banks.

However, their paper sets aside the issue that TBTF subsidy is about the expectation of government support lowering the cost of funds relative to what they would have been

⁷⁴ They find that non-bank financial s enjoyed a much higher benefit of 77 bps for the same period.

otherwise. Carney (2013) argues that TBTF banks take on far more risk (see Schnabel 2004, 2009) and more debt than smaller banks. He points out this study of Goldman Sachs does not control for risk and leverage metrics and therefore the fact that that risky debt-laden large banks pay only 10 basis point more on their debt would be an evidence of implicit subsidies. Related to the returns to taxpayers, one would need to look into more aggregate data and not only one program. Laeven and Valencia (2012) find that recent financial crisis 2007-2009 has increased the burden of public debt and size of government contingent liabilities, creating concerns about fiscal sustainability in some countries. They estimate that there are direct fiscal costs reaching 6% of GDP in advanced economies for measures such as capitalisation of banks, provision of liquidity and guarantees and asset purchases. Furthermore, Morrison (2011) claims that one should also take into account that funds are diverted from alternative uses, potentially at a significant opportunity cost and therefore the profit net of opportunity costs will surely be much lower. Also, irrespective of whether to government makes a loss or a benefit this should not have an impact on creditors and therefore the distortions of the implicit subsidy. It would imply that bailouts do not really create a subsidy for large banks as they instead make money for taxpayers.

Araten and Turner (2012) (JP MorganChase) also provide an estimate of the funding cost advantage that large banks enjoy and end up with lower estimate of implicit guarantees compared to other studies. They look in globally Systemically Important Banks (G-SIBs defined as institutions with more than USD 500 billion in assets) in the US and find moderate cost advantages associated with the GSIB status of 9 bps taking into account all funding cost sources (and if one considers only interest bearing funding sources this increases to 18bps). The main funding advantage is with regard to domestic deposits (23bps) but there are also smaller cost advantages with respect to credit spreads on senior, unsecured debt (and higher costs for Fed Funds). They explain that this relatively small difference in funding costs is due to the difference in funding mix between GSIB and non-GSIBs as non-GSIBs rely more heavily on deposits (that have relatively lower funding costs than other categories).

This analysis shows that there are composition effects that however are not accounted for in their analysis. The fact that larger banks are able to expand their balance sheet with lower share of deposits makes comparisons of individual categories of funding less informative if one does not control for the underlying structure of liabilities of different banks. Also risk factors are not accounted for. Furthermore, Noss and Sowerbutts (2012) suggest that this paper assumes that banks' funding advantage due to TBTF status to be invariant over time and that a number of endogenous variables are included (e.g. profitability which is itself affected by spread).

JRC work

As highlighted above, the JRC has also worked on the quantification of implicit subsidies. This analysis follows the rating based methodology of funding cost models and in addition to quantifying the implicit subsidy it also investigates the determinants of the government support on a sample of 112 large EU banks representing around 60-70% of EU banking total assets. Based on Moody's data on all-in ratings and stand-alone data JRC first computes the uplift across these banks that is due to government support and finds that it lies between 2 and 3 notches. Also, JRC has constructed a yield curve to translate the uplift into an estimate of the total funding cost advantage in euros. The estimate of the implicit subsidy for their sample is UR 72-95 billion and EUR 59-82 billion in 2011 and 2012, respectively, for the

banks considered. In relative terms, the implicit subsidy estimate is in the range of 0.5% to 0.8% of EU-27 GDP. However there is some variation across countries as the estimates are largely dependent on the size of the banking sector in each country and the sovereign credit rating, as well as the sample construction. The importance of the subsidies is also illustrated by the fact that it account between one-third and one-half of the aggregate annual pre-impairment operating profit of the banks.

The econometric analysis confirmed the findings of the literature showing that the uplift is associated with the size of the bank, the banks' stand-alone strength and the sovereign (in which the bank is headquartered) ratings. Larger banks are more likely to receive a relatively higher uplift. Banks are likely to be TBTF due to their size, their interconnectedness or importance to the financial systemic. As size is likely to be highly correlated to TBTF status, this indicates that larger banks are likely to benefit more from government support. A common finding in the literature is that the rating of the country in which banks are headquartered is important. JRC's work confirms that banks that are headquartered in a country with a strong sovereign credit rating are more likely to benefit from a higher uplift for a bank, raising questions on the level playing field in the internal market. Furthermore, a higher stand-alone rating increases the likelihood of observing lower uplift. Components of the individual strength rating of a company relate to the riskiness of the banks (see Moody's methodology (2011)). Therefore, a bank that is considered more risky is likely to receive a higher uplift. The results also show that banks with stronger parents are more likely to receive support within the group rather than from the government.

JRC also extended the analysis by including several balance sheet indicators to investigate whether the uplift is likely to be affected by bank business model. Before commenting on the results of this extended model, the Commission notes that it is demanding to require from a reduced form model to provide unequivocal evidence on the importance of business model. Overall, however, the Commission considers that the regression analysis provides some evidence that the business model variables affect the level of the uplift. Two variables that are significant are the variables that relate to the bank's level of interconnectedness. Banks that hold a larger proportion of net loans to banks in their total assets and banks that rely more on wholesale market for funding are more likely to benefit from a higher implicit guarantee. Also, banks that are better capitalised benefit from lower uplift.

The full report is provided in Annex A4.2.

4. CONCLUSION

There are several explicit or implicit safety nets for banks to deal as even solvent banks are susceptible to bank runs and given the importance of the banking sector for the real economy. Governments often step in and bail-out banks as evidenced during the financial crisis. To the extent that these guarantees are mispriced they lead to several distortions. Anticipating public support for the banks, their creditors have lower incentive to monitor banks' activities. As a result moral hazard arises and banks' managers are willing to take higher risks. Implicit subsidies for banks also imply artificially higher returns for the sector attracting resources from other sectors of the economy. Furthermore, as certain types of banks are more likely to benefit from the implicit subsidy this also distorts the level playing field across banks. For example, large banks, which are more likely to be TBTF, benefit disproportionately from implicit subsidies compared to their smaller counterparts. Also, as the value of the implicit

subsidy depends on the credibility of the guarantor, banks headquartered in countries with good public finances are more likely to benefit from such a subsidy.

There are several studies on the quantification of implicit subsidies. The results of these studies are highly dependent on the methodology employed as well as the sample (banks, geographic scope, time period) under consideration. Overall, however, they point out that implicit subsidies are present, sizeable and can represent a significant advantage for larger banks. Debt holders, depositors and shareholders are likely to benefit from implicit subsidies. However, studies typically focus on one type of stakeholder even though the overall benefits to TBTF banks might be expected to accrue to several parties. Implicit subsidies are found to represent a significant share of countries' GDP (typically more than 0.5%) and of banks' profits (more than 30% in some studies). JRC findings confirm previous findings of the literature: larger banks are likely to benefit relatively more from implicit subsidies. Also, banks headquartered in a country with higher rating are benefiting from a higher uplift. When investigating the role of business model variables, it is found that the degree of banks' interconnectedness also affects the uplift, with more interconnected banks enjoying a higher uplift.

5. BIBLIOGRAPHY

Acharya, V., I. Drechsler and P. Schnabl (2010), “A Pyrrhic Victory? Bank Bailouts and Sovereign Credit Risk”, Working paper, NYU-Stern, CEPR Discussion Paper 8679.

Acharya, V., D. Anginer, and J. Warburton (2013), “The End of Market Discipline? Investor Expectations of Implicit State Guarantees”, working paper, http://papers.ssrn.com/sol3/papers.cfm?abstract_id=1961656

Admati, A. and M. Hellwig (2013), “The Bankers’ New Clothes: What’s Wrong with Banking and What to Do about It”, *Princeton University Press*

Araten, M., and C. Turner (2012), ‘Understanding the funding cost differences between globally systemically important banks (G-SIBs) and non G-SIBs in the United States’, mimeo, http://papers.ssrn.com/sol3/papers.cfm?abstract_id=2226939.

Baker, D. and T. McArthur (2009), ‘The value of the ‘too big to fail’ big bank subsidy,’ CEPR Reports and Issue Briefs 2009-36, Center for Economic and Policy Research.

Benston, G., W. Hunter, and L. Wall, (1995), “Motivations for Bank mergers and acquisitions: enhancing the deposit insurance put option versus earnings diversification.” *Journal of Money, Credit, and Banking*, Vol. 27, No. 3, pp. 777-788.

Bijlsma M. and R. Mocking (2013), “The private value of too-big-to-fail guarantees”, CPB Netherlands Bureau for Economic Policy Analysis, CPB Discussion Paper 240.

Blundell-Wignall, A., G. Wihinger, and P. Slovik (2009), “The Elephant in the Room: The Need to Deal with What Banks Do”, OECD Financial Market Trends Vol. 2009/2.

Brewer, E. and J. Jagtiani (2011), "How much did banks pay to become Too-Big-To-Fail and to become systemically Important?", Federal Reserve Bank of Philadelphia, working paper No. 11-37.

Dam, L. and M. Koetter, (2012), "Bank Bailouts and Moral Hazard: Evidence from Germany," *Review of Financial Studies, Society for Financial Studies*, vol. 25(8), pages 2343-2380.

Diamond, D. (1984), “Financial intermediation and delegated monitoring”, *Review of Economic Studies*, 51, pp. 393-414.

Diamond, D. and P. Dybvig (1983), “Bank runs, deposit insurance and liquidity”, *Journal of Political Economy*, 91, pp.401-19.

Estrella, A. and S. Schich (2011), “Sovereign and banking sector debt: Interconnections through implicit guarantees”, OECD Financial Market Trends Vol. 2011/2.

Flannery, M. and S. Sorescu, (1996). "Evidence of Bank Market Discipline in Subordinated Debenture Yields: 1983-1991," *Journal of Finance, American Finance Association*, vol. 51(4), pages 1347-77, September.

Freixas X., J-C. Rochet, and B. Parigi (2004), "The Lender of Last Resort: A Twenty-First Century Approach," *Journal of the European Economic Association*, MIT Press, vol. 2(6), pages 1085-1115.

Goldman Sachs (2013), "Measuring the TBTF effect on bond pricing", Global Markets Institute.

Gropp, R., C. Gruendl, and A. Guettler (2010a), "The Impact of Public Guarantees on Bank Risk Taking: Evidence from a Natural Experiment", European Central Bank, Working Paper Series, No 1272.

Gropp R., H. Hakenes, and I. Schnabel (2010b) "Competition, Risk-Shifting, and Public Bail-out Policies, Max Planck Institute for Research on Collective Goods, Bonn, 2010/05.

Haldane, A. (2012), "On being the right size", The 2012 Beesley Lectures, at the Institute of Directors, London.

Jacewitz, S and J. Pogach (2013), "Deposit Rate Advantages at the Largest Banks", working paper, http://papers.ssrn.com/sol3/papers.cfm?abstract_id=2018474

Kane, E. (2000), "Incentives for Banking Megamergers: What Motives Might Regulators Infer From Event-Study Evidence?," *Journal of Money, Credit and Banking*, 32(3), 671–701.

Kane, E. (2009), "Extracting Non-transparent Safety Net Subsidies by Strategically Expanding and Contracting a Financial Institution's Accounting Balance Sheet," *Journal of Financial Services Research*, Springer, vol. 36(2), pages 161-168, December.

Keeley, M. (1990): "Deposit Insurance, Risk, and Market Power in Banking," *American Economic Review*, 80, 1183 – 1200.

Kydland, F. and E. Prescott, (1977), "Rules Rather Than Discretion: The Inconsistency of Optimal Plans," *Journal of Political Economy*, University of Chicago Press, vol. 85(3), pages 473-91, June.

Li, Z., S. Qu, and J. Zhang (2011), 'Quantifying the value of implicit government guarantees for large financial institutions', Moody's Analytics Quantitative Research group, January.

López-Espinosa, G., A. Moreno, A. Rubia, L. Valderrana, and R. Calderón (2013), "Drivers of Fiscal Outlays in Banks Recapitalizations", Working paper, <http://gbif.ch/files/content/sites/irene/files/shared/documents/s%C3%A9minaires/Lopez.pdf>

Marques, L., R. Correa, and H. Sapriza (2013), "International Evidence on Government Support and Risk Taking in the Banking Sector", IMF Working Paper, 13/94.

Merton, R. (1977), "An analytic derivation of the cost of deposit insurance and loan guarantees An application of modern option pricing theory," *Journal of Banking & Finance*, Elsevier, vol. 1(1), pages 3-11, June.

Mishkin, F. (2006) “How big a problem is Too Big to Fail? A review of Gary Stern and Ron Feldman's Too Big to Fail: The Hazards of Bank Bailouts”. *Journal of Economic Literature*, Vol. XLIV, pp. 988-1004.

Molyneux, P., K. Schaeck, and T. Zhou (2010), ““Too-Big-to-Fail” and its Impact on Safety Net Subsidies and Systemic Risk”, Center for Applied Research in Finance, Bocconi University, Working paper 09/2010

Moody's (2011), “Status Report on Systemic Support Incorporated in Moody's Bank Debt Ratings Globally”, Moody's Investor Service, Special Comment.

Moody's (2012a) “Incorporation of joint-default Analysis into Moody's Bank Ratings: Global Methodology”, Moody's Investor Service.

Moody's (2012b), “Moody's Consolidated Global Bank rating Methodology”, Moody's Investor Service.

Morgan, D., and K. Stiroh (2005), “Too Big to Fail after all these years”, Federal Reserve Bank of New York, Staff Report, No. 220.

Morrison, A. (2011), “Systemic Risks and the “too-big-to-fail” problem”, *Oxford Review of Economic Policy*, Volume 27/3, pp.498-516.

Noss, J. and R. Sowerbutts (2012), “The implicit subsidy of banks”, Bank of England, Financial Stability Paper No. 15.

O'Hara, M. and W. Shaw (1990), “Deposit Insurance and wealth effects: the value of being “Too Big To Fail””. *Journal of Finance*, Vol. 45, pp. 1587-1600.

Oxera (2011), “Assessing State Support to the UK Banking Sector”, prepared at the request of the Royal Bank of Scotland, March.

Penas, M.F. and H. Unal (2004), “Gains in Bank Mergers: Evidence from the Bond Markets”. *Journal of Financial Economics*, vol. 74, pp. 149-179.

Pop, A. and D. Pop (2009), “Requiem for market discipline and the specter of TBTF in Japanese banking”. *The Quarterly Review of Economics and Finance*, vol. 49, pp. 1429-1459.

Rime, B. (2005), “Do “Too Big To Fail” Expectations Boost Large Banks Issuer Ratings?” Working Paper, Systemic Stability Section, Swiss National Bank.

Schich, S. and S. Lindh (2012), “Implicit Guarantees for Bank Debt: Where Do We Stand?”, OECD Journal: Financial Market Trends, vol. 2012 Issue 1.

Schweikhard, F. and Z. Tsismelidakis (2012). “The Impact of Government Interventions on CDS and Equity Markets”. Available at SSRN: <http://ssrn.com/abstract=1573377>.

Sironi, A. (2003), “Testing for Market Discipline in the European Banking Industry: Evidence from Subordinated Debt Issues” *Journal of Money, Credit, and Banking*, Vol. 35, No. 3, pp. 443-472.

Stern, G. and R. Feldman (2004), “Too Big to Fail: The Hazards of Bank Bailouts”, Washington, D.C., Brooking Institution Press.

Ueda, K and B. Di Mauro (2012), ‘Quantifying structural subsidy values for systemically important financial institutions’, IMF Working Paper No. 128.

Völz, M. and M. Wedow (2009) “Does Banks’ Size Distort Market Prices? Evidence for Too-Big-to-Fail in the CDS Market”. Discussion Paper, No. 06/2009, Deutsche Bundesbank.

APPENDIX A: SUMMARY OF LITERATURE

Paper	Methodology	Sample	Result
Funding advantage models			
Size based			
<i>Baker and McArthur (2009)</i>	Consider that all banks with assets in excess of \$100 billion will receive government support. They use the change in the difference in funding costs between banks above and below this threshold around a bailout event as an estimate of the subsidy.	The change in subsidy is computed for the 18 US banks with more than \$100 billion assets. The compare pre and post crisis.	They find an increase in the gap of cost of funding of 49bps (pre and post crisis) which implies a government subsidy of \$34.1 billion a year to the 18 bank holding companies with more than \$100 billion in assets in 2009Q1
<i>Li, Qu and Zhang (2011)</i>	The spread difference between the Moody's proprietary credit rating CDS spreads (FVS) and CDS spreads is taken as proxy for TBTF premium.	Top 20 US banks and top 20 European banks from 2001 to 2011	From 2001 to 2010 the spread premium was 23 bps larger for larger banks which increased to 56 bps post crisis in the US. Figures for Europe are 3 bps increasing to 51bps post crisis. This translates to an implicit guarantee of \$102 -170 billion for the top 20 US banks and USD 176-293 billion for the top 20 European.

26

<i>Araten and Turner (2012)</i>	They regress each funding element (deposits, Fed Funds and report, and senior debt) on a number of explanatory variables (fundamental variables, credit risk measures, economic state variables and market liquidity variables for bonds and CDS)	They look at the Bank Holding level in the US. They define GSIB as a BHC with more than \$500 billion at any point in time over the period 2002Q1-2011Q1	They claim relatively small overall differences in funding costs due to the different composition of funding (smaller banks focused more on relatively cheaper deposits). They find that SIFIs have approximately 23 bps lower cost of deposits, 19bps higher costs for Fed Funds and repos and 3% lower option adjusted spread cost advantage (which is though non-significant).
<i>Acharya, Anginer and Warburton (2011)</i>	They first run a regression of the spread on the size of the institution, its risk and several bond, institution and macro controls	They focus in the period 1990-2010. Their sample includes 567 US financial institutions	The average annual funding cost advantage is approximately 28 bps before the financial crisis peaking at 120 bps in 2009. The total value of subsidy amounted to \$20billion per year before crisis reaching \$200billion in 2009
Rating based			
<i>Packer and Tarashev (2011)</i>	They employ data on the uplift from the three main CRAs and provide descriptive statistics	70 worldwide large banks in two points in time (mid 2007 and April 2011)	In mid-2011 Europe and US support has improved banks' ratings by 3 notches on average, increasing from 2 notches in 2007.
<i>Haldane (2012)</i>	Computes the uplift on the basis of Moody's data and translate it into	29 SIFIs from 2002 to 2012	Uplift of 1.3 on average between 2002-2007 which translates to \$ 70

27

	subsidy estimation		billion per year (50% of the average post-tax profits of these banks). By 2009, uplift increased to 3 and the subsidy estimated at over \$700 billion per year.
<i>Schich and Lindh (2012)</i>	Computes the uplift on the basis of Moody's data and translate it into subsidy estimation; also regress the uplift on the relative size of the relative position to its peers in a given country	118 large European banks between 2007 and March 2012	In March 2012 the estimated yearly reduction in funding costs were USD 35 billion in Germany (more than 1% of GDP), USD 15 billion in France (0.3% of GDP) and USD 10 billion in the UK (0.4% of GDP); Relative size of bank affects the subsidy
<i>Estrella and Schich (2012)</i>	Computes the uplift on the basis of S&P (and Moody's and Fitch) data. The regress the uplift on stand-alone rating and sovereign rating	100 largest European banks in April 2011	Weaker banks and banks with strong sovereigns benefit from larger subsidies. A 2 notch increase/decrease in sovereign/stand-alone rating leads to 1 notch uplift
<i>Ueda and di Mauro (2012)</i>	Computes the uplift on the basis of Fitch data. They regress all-in rating of bank on the banks' stand-alone rating and expected support controlling for macro conditions and country fixed effects using an ordered <u>probit</u> regression at a given	895 banks from 16 OECD countries at end of 2007 and end of 2009.	Funding advantage of around 60bp in 2007 and 80bp in 2009

	point in time.		
<i>Bijlsma and Mocking (2013)</i>	They estimate the predicted yield based on all-in rating and for stand-alone ratings with the difference providing the yield reduction. They then translate this into an estimate of the implicit subsidy. They also regress the relative uplift on a number of bank and country characteristics and use several variables to capture the TBTF nature of the banks.	151 relatively large European Banks between 2006 and July 2012.	Uplift of 1-2 notches pre-crisis, 3.6 notches in 2010 and 2.5 in 2012. Implicit subsidy peaked at EUR 150 billion in mid-2011. At national level the peak of the subsidy represent 1.5% of GDP for France and Germany falling to 1% at July 2012. The relative rating uplift of TBTF banks is on average 13% higher than for smaller banks
Contingent claims models			
<i>Oxera (2011)</i>	The subsidy is modelled as the shortfall between the value of banks' assets and some threshold based on their minimum capital requirements at some future time	Five listed UK banks in September/October 2010	Advantage of 8bps per £1 of assets which corresponds to overall 5.9 billion annual transfer for September/October 2010 in the UK



JRC SCIENTIFIC AND POLICY REPORTS

Annex A4.2 : Size and determinants of implicit state guarantees to EU banks

J Cariboni, H. Joensson, L. Kazemi Veisari,
D.Magos, E. Papanagiotou, C. Planas

2013

European Commission

Joint Research Centre

Institute for the Protection and Security of the Citizen

Contact information

Jessica Cariboni

Address: Joint Research Centre, Via Enrico Fermi 2749, TP 361, 21027 Ispra (VA), Italy

E-mail: jessica.cariboni@jrc.ec.europa.eu

Tel.: +39 0332 78 9372

Fax: +39 0332 78 5733

<http://ipsc.jrc.ec.europa.eu/>

<http://www.jrc.ec.europa.eu/>

Legal Notice

Neither the European Commission nor any person acting on behalf of the Commission is responsible for the use which might be made of this publication.

Europe Direct is a service to help you find answers to your questions about the European Union

Freephone number (*): 00 800 6 7 8 9 10 11

(*): Certain mobile telephone operators do not allow access to 00 800 numbers or these calls may be billed.

A great deal of additional information on the European Union is available on the Internet.

It can be accessed through the Europa server <http://europa.eu/>

.JRC84687

© European Union, 2013

Joint
Research
Centre

Executive summary

The European Commission is bringing forward a proposal for a structural reform of the EU banking sector to tackle problems arising from banks being Too-Big-To-Fail (TBTF), including too-important-to-fail, too-complex-to-fail and too-interconnected-to-fail. It has been argued that banks that are viewed to be TBTF might enjoy an implicit government guarantee, because governments will not allow these banks to fail. This implicit guarantee thus improves these banks perceived credit worthiness and is observed as an upgrade in their long term credit ratings. As the bank's funding cost (measured in basis points) depends on its credit rating, the implicit guarantee gives rise to a funding cost advantage: bank creditors do not demand full compensation for being exposed to banks' risks, because bank creditors expect government bailouts to avoid troubled banks to fail. Multiplying the funding cost advantage with a share of the outstanding debt results in a monetary estimate which can be viewed as an implicit subsidy given to banks.

The present report investigates the size and determinants of the implicit state guarantee enjoyed by a sample of 112 EU banks covering 60-70% of the total bank assets in the EU over the period 2011-2013. It also estimates the implicit subsidy.

The implicit guarantee is derived from Moody's credit ratings. Long-term credit ratings take into account the bank's stand-alone financial strength, a rating upgrade due to possible support from a parent or a cooperative group, and a rating upgrade due to potential government support. This third component is used to measure the implicit government guarantee. The implicit guarantee is translated into a funding cost advantage by comparing the funding cost inferred from the long-term credit rating of a bank with the funding cost inferred from its stand-alone credit rating.

Results can be summarized as follows:

1) Estimation of the implicit guarantee using ratings

For about 80% of the banks the rating uplift due to potential government support corresponds to a one to three notches upgrade. For the largest 25% of the banks this upgrade is up to 26% higher than for the other banks. The average upgrade due to implicit guarantee is relatively stable over the period under study, while a decrease in the average long term credit rating can be observed.

2) Estimation of the implicit subsidy

An estimate for the total implicit subsidy is **EUR 72-95 billion and EUR 59-82 billion** in 2011 and 2012, respectively, for the banks considered. In relative terms, the implicit subsidy estimate is in the range of 0.5% to 0.8% of EU-27 GDP. We also find that the total implicit subsidy is between one-third and one-half of the aggregate annual pre-impairment operating profit of the banks.

3) Determinants of the implicit guarantee

In our sample of EU banks, results of an econometric analysis show that the implicit guarantee (measured through the rating upgrade) appears to be driven by:

- The bank individual strength: a higher individual strength rating increases the probability of observing lower implicit guarantee;
- The parental support: banks with stronger parents receive a lower implicit guarantee.
- The credit rating of the country where a bank is headquartered: being headquartered in a country with a strong sovereign credit rating increases the probability of observing a higher implicit guarantee. This evidence also appears if the debt to GDP ratio is used as a proxy for the sovereign credit worthiness.
- The size of the bank: larger banks are more likely to enjoy a greater implicit guarantee.

Concerning the business model we find the following evidence:

- More inter-connected banks that hold a larger proportion of net loans to banks in their total assets are more likely to benefit from a higher implicit guarantee.
- Banks that rely more on the wholesale market for funding (i.e. a high wholesale funding ratio) are also more likely to benefit from a higher implicit guarantee.
- Better capitalized banks are more likely to receive a lower implicit guarantee.

TABLE OF CONTENTS

EXECUTIVE SUMMARY	81
1.INTRODUCTION	85
2.LITERATURE REVIEW	86
2.1 CREDIT RATINGS AS INDICATORS OF IMPLICIT STATE GUARANTEE	86
2.2 QUANTIFICATION OF THE IMPLICIT SUBSIDY	87
3.ESTIMATION OF THE IMPLICIT GUARANTEE	89
3.1 DATA DESCRIPTION	89
3.2 DESCRIPTIVE STATISTICS ON THE UPLIFT/UPLIFT*	92
4.ESTIMATION OF THE IMPLICIT SUBSIDY	103
4.1 METHODOLOGY	103
4.2 THE RATING-YIELD CURVE MAP	103
4.3 PROXIES OF RATING SENSITIVE LIABILITIES.....	107
4.4 IMPLICIT SUBSIDY ESTIMATES	108
4.5 COMPARING IMPLICIT SUBSIDY WITH PRE-IMPAIRMENT OPERATING PROFIT'	113
4.6 RELATION BETWEEN IMPLICIT SUBSIDY AND BANK CHARACTERISTICS	113
5.DETERMINANTS OF THE IMPLICIT GUARANTEE.....	116
5.1 DATASET AND EXPLANATORY VARIABLES.....	116
5.2 ECONOMETRIC METHODOLOGY.....	122
5.3 EMPIRICAL RESULTS WITHOUT BUSINESS MODEL VARIABLES	123
5.4 EMPIRICAL RESULTS WITH BUSINESS MODEL VARIABLES.....	128
6.CONCLUSIONS.....	133
REFERENCES	135
APPENDIX A: LIST OF BANKS.....	137

APPENDIX B: STATISTICS ON MOODY’S RATING DATA	140
APPENDIX C: COMPARISON WITH THE EXISTING LITERATURE	145
APPENDIX D: UPLIFT* FOR SELECTED LARGE EU GROUPS	151
ANNEX E: DESCRIPTIVE STATISTICS OF THE SAMPLE USED FOR BUILDING THE RATING-YIELD MAP	152
APPENDIX F: DESCRIPTION OF THE PROXIES FOR THE RATING-SENSITIVE LIABILITIES.....	154
APPENDIX G: IMPLICIT SUBSIDY VERSUS PRE-IMPAIRMENT OPERATING PROFIT.....	156
APPENDIX H: IMPLICIT SUBSIDY VERSUS BANK CHARACTERISTICS	158
APPENDIX I: SNL BUSINESS MODEL VARIABLES DESCRIPTION	161
APPENDIX J: MARGINAL EFFECTS IN PROBIT REGRESSION.....	163

1. Introduction⁷⁵

The European Commission is bringing forward a proposal for a structural reform of the EU banking sector to tackle problems arising from banks being Too-Big-To-Fail (TBTF), including too-important-to-fail, too-complex-to-fail and too-interconnected-to-fail. It has been argued that banks that are viewed to be TBTF might enjoy an implicit government guarantee, because governments will not allow these banks to fail. This implicit guarantee thus improves these banks perceived credit worthiness and is observed as an upgrade in their long term credit ratings. As the bank's funding cost (measured in basis points) depends on its credit rating, the implicit guarantee gives rise to a funding cost advantage: bank creditors do not demand full compensation for being exposed to banks' risks, because bank creditors expect government bailouts to avoid troubled banks to fail. Multiplying the funding cost advantage with a share of the outstanding debt results in a monetary estimate which can be viewed as an implicit subsidy given to banks.

The aim of this report is two-fold. The first aim is to estimate the size of the implicit government guarantee (measured through the rating upgrade) of EU banks and to investigate its determinants via an econometric analysis. The second aim is to estimate the implicit subsidy due to this guarantee.

To measure the size of the implicit guarantee, we rely on the *rating-based approach using Moody's credit ratings*. Long-term credit ratings take into account the bank's stand-alone financial strength rating, a rating upgrade due to possible support from a parent or a cooperative group, and a rating upgrade due to potential government support. This third component is used to measure the implicit government guarantee. The implicit guarantee is translated into a funding cost advantage by comparing the funding cost inferred from the long-term credit rating of a bank with the funding cost inferred from its stand-alone credit rating.

Studies in the literature (Schich and Lindh (2012) and Schich and Kim (2012)) suggest that the implicit guarantee depends on the strength of the sovereign where the bank is headquartered and also on the size of the bank. This document extends the set of possible drivers of the implicit guarantee and investigates whether bank business profile also plays a role in the size of the implicit guarantee.

The rest of this document is structured as follows. Section 2 summarizes the available literature. Section 3 describes the Moody's ratings used to estimate the implicit guarantee and presents some statistics. Section 4 focusses on the quantification of the implicit subsidy. Section 5 presents the econometric analysis performed to assess the determinants of the implicit guarantee and the last section concludes.

Some technical Annexes are enclosed to present additional statistics on the datasets employed and to present the Probit model used for the econometric analyses.

⁷⁵ The authors would like to thank S. Maes and M. Marchesi for useful comments and discussion.

2. Literature review

The methodology followed in this work relies on the previous work of Schich and Lindh (2012), Ueda and Di Mauro (2012) and Schich and Kim (2012). A brief description of the methodology is provided below.

The three largest credit rating agencies provide two types of ratings for a bank:

- An "all-in credit rating" (AICR) that factors in the possibility and likelihood of external support that the bank receives when needed from its parent, a cooperative or public authorities (including government support);
- a "stand-alone credit rating" (SACR) that abstracts from such support.

The difference between these two ratings is referred to as the rating UPLIFT:

$$\text{UPLIFT} = \text{AICR} - \text{SACR}. \quad (1)$$

The UPLIFT thus factors in the effects of guarantees from the government and from other types of support, such as parental and cooperative. Since 2011, Moody's has also started publishing an adjusted SACR (SACR*), that includes parental and cooperative support but not government support. Using SACR*, an adjusted uplift (UPLIFT*) can be calculated:

$$\text{UPLIFT}^* = \text{AICR} - \text{SACR}^*. \quad (2)$$

The UPLIFT* measures the increase in the rating due to government support.

2.1 Credit ratings as indicators of implicit state guarantee

Schich and Lindh (2012) employ a dataset of 118 European banks from 17 European countries for calculating the UPLIFT and the UPLIFT*. This study uses ratings from Moody's and covers the period between end 2007 and first quarter of 2012. A general conclusion is that EU banks typically enjoy implicit guarantee and that the sample of banks enjoying an implicit state guarantee extends beyond the list of systemically important banks defined by the Financial Stability Board. They find that implicit guarantees have increased during 2009 and 2010. However, overall implicit state and parental support are persistent, as they provide evidence that there is not a major difference in the UPLIFT for the time period under study. When the UPLIFT* is examined on a country by county basis it is shown that implicit support is present for all the countries under study, although its magnitude varies across counties. Schich and Lindh (2012) also attempt to provide an insight into the determinants of the UPLIFT* by using a cross-section regression with country-fixed effects. They run a least squares regression where the adjusted stand-alone credit rating (SACR*), the domestic sovereign credit rating and the relative size of each bank are used as explanatory variables. They conclude that: (i) the lower the

adjusted stand-alone credit rating (SACR*), (ii) the better the domestic sovereign rating, and (iii) the larger the bank, the higher the implicit state guarantee.⁷⁶

In contrast to Schich and Lindh (2012), who fit a linear probability model, Ueda and Di Mauro (2012) employ ordered probit regressions with country-fixed effects. They use ratings from Fitch in order to estimate implicit state guarantee for 895 global banks in two points in time: 2007 and 2009. They also confirm that the funding cost advantage increased substantially during the crisis: from 60 basis points (bps) at the end of 2007 80 bps in end 2009.

Bijlsma and Mocking (2013) employ Moody's ratings to calculate the UPLIFT for 151 European banks for the time period 2006 to 2011. They conclude that the average UPLIFT reached its maximum in 2010 (i.e. 3.6 notches) and then dropped to 2.5 notches in 2012. Their results show that larger banks (above some threshold value based on total assets) enjoy on average higher UPLIFT and a higher sovereign rating of a bank's home country leads on average to a higher UPLIFT for that bank.

Noss and Sowerbutts (2012) report the average UPLIFT for four UK banks from 2007 to 2010 by using Moody's ratings. They show that the average UPLIFT for the UK banks in their sample has declined from about 3.5 notches in 2009 to one notch in 2010.

Haldane (2010) using Moody's ratings reports that expected government support, for a sample of about 16 UK banks and 26 global banks, has increased on average 2 notches between 2007 and 2009. Moreover, his analyses also show that the UPLIFT is higher for large than for small banks in the considered sample.

In a subsequent paper, Haldane (2012) reports the evolution of the UPLIFT for the 29 world's most systemically-important institutions calculated from Moody's ratings. The reported time period is from 2007 to 2012. Once more, in Haldane (2012) it is confirmed that levels of support are higher after the crisis. Indeed, the average UPLIFT has increased around 2.8 notches in 2012 from about 1.5 notches in 2007.

All available studies using the credit rating methodology thus conclude that banks in the EU and worldwide benefit from a considerable implicit state support, as reflected by an increase in their credit rating.

2.2 Quantification of the implicit subsidy

On the basis of bank bond data one can construct a map between credit ratings and bond yields. To estimate the funding advantage we compare the difference between the bank's cost of funding given its all in credit rating with the funding cost based on its stand-alone rating. This latter cost

⁷⁶ One must be cautious in interpreting the results of Schich and Lindh (2012) as they fit a linear probability model to numerically-translated ratings. Indeed, handling categorical variables as if they were continuous leads to the well-known flaws of the linear probability model such as heteroskedasticity and non-normality of residuals. These flaws may make inference invalid.

of funding is assumed to be the funding cost the bank would experience if the implicit government guarantee were not present. An estimate of the implicit subsidy can be obtained by multiplying the funding advantage in basis points with the amount of rating sensitive liabilities of the bank. One must be cautious when making a comparison of results among different studies due to differences in: i) the definition of rating sensitive liabilities, ii) the sample of banks and the time period considered, iii) the sample of bonds used in the building of the map, iv) the precise methodology used for the estimation of the yield spreads.

Haldane (2010) uses a proxy of rating sensitive liabilities that excludes retail deposits but includes wholesale borrowing. The estimated subsidy of 16 UK banks is 11, 59 and 107 GBP billion in 2007, 2008 and 2009, respectively. The five largest UK banks benefit primarily from this subsidy, as the estimates for them are 9, 52, and 103 GBP billion in 2007, 2008 and 2009, respectively.

Noss and Sowerbutts (2012) define a proxy of rating sensitive liabilities as the sum of deposits from other banks and financial institutions, some financial liabilities designated at fair value (debt securities, deposits), and certain debt securities in issue (commercial paper, covered bonds, other debt securities and subordinated debt). The implicit subsidy of the major UK banks (Barclays, HSBC, Lloyds Banking Group, and Royal Bank of Scotland) is estimated equal to around 5, 25, 130, and 40 GBP billion in 2007, 2008, 2009, and 2010, respectively.

Schich and Lindh (2012) make use of a proxy for rating sensitive liabilities equal to the “outstanding bonds and loans” issued in the market, which is readily available from Bloomberg. Schich and Lindh (2012) calculate a lower bound of implicit subsidy based on outstanding bonds and loans issued by the rated entity only, and an upper bound where the debt of subsidiaries are also included.

Bijlsma and Mocking (2013) estimate the relationship between bond yields and Moody’s long-term deposit ratings using ordinary least squares regression. The amount of long-term funding is used as a proxy for rating sensitive liabilities. The total implicit subsidy ranges from around EUR 20 billion in early 2008 to peak at almost EUR 150 billion in mid-2011. It falls to around EUR 100 billion in the beginning of 2012.

In conclusion, irrespective of the methodology used, the sample of banks and the period considered, the amount of the implicit subsidies is significant.

3. Estimation of the implicit guarantee

3.1 Data description

Countries and time period

Our sample consists of 112 European banks from 23 countries (BE, BG, CZ, DK, DE, IE, EL, ES, FR, IT, CY, LU, HU, NL, AT, PL, PT, RO, SI, SK, FI, SE, UK).⁷⁷ The sample represents between 60% and 70% of EU banking total assets as of end of 2011⁷⁸. The EU G-SIBs are all represented in the sample with the exception of Groupe BPCE for which data on ratings are not available.⁷⁹ The time period under study is from 2007 to 2012, and the data frequency is six months. For comparison purposes, data for the first quarter of 2013 are also included in the analysis.

Ratings description

The following Moody's ratings are used in the analysis:

- a) Bank Financial Strength Rating (BFSR): it represents the ratings agency's opinion of the banks intrinsic safety and soundness. It does not take into account the probability that the bank will receive external support from its parental company or public authorities. This is an estimate of SACR in equation (1) above.
- b) Baseline Credit Assessment (BCA): the BFSR is mapped to the BCA (Moody's started publishing the BCA in 2011), which express the bank's intrinsic financial strength using the aaa – c scale (see Table 1). BCA is therefore also an estimate of SACR in Equation (1) above. This approach was also followed by Schich and Lindh (2012).
- c) Adjusted Baseline Credit Assessment (adjBCA): in contrast to the BCA, which represents the bank's stand-alone rating, the Adjusted BCA factors in the effect of parental and cooperative support (SACR* in Equation (2) above).
- d) Long Term Issuer Rating (LT) used to estimate the all-in credit rating (AICR) for each bank. In cases where the Long Term Issuer Rating is not available, the Senior Unsecured or the Long Term bank Deposits ratings is used. LT is reported on the Aaa – C scale.
- e) Sovereign Long Term Rating for the countries under study, necessary for the econometric analysis in Section 5.

⁷⁷ Appendix A provides a list of the banks used

⁷⁸ Source: ECB statistics.

⁷⁹ For some G-SIBs no stand-alone ratings are available at group/holding level, thus the focus is on the main bank (e.g. Barclays and Standard Chartered are included in the sample as Barclays Bank PLC and Standard Chartered Bank).

Table 1: Moody's ratings: classes and mapping

BFSR	BCA/adjBCA	LT issuer	Notch
A	aaa	Aaa	20
A-	aa1	Aa1	19
B+	aa2	Aa2	18
B	aa3	Aa3	17
B-	a1	A1	16
C+	a2	A2	15
C	a3	A3	14
C-	baa1	Baa1	13
C-	baa2	Baa2	12
D+	baa3	Baa3	11
D+	ba1	Ba1	10
D	ba2	Ba2	9
D-	ba3	Ba3	8
E+	b1	B1	7
E+	b2	B2	6
E+	b3	B3	5
E	caa1	Caa1	4
E	caa2	Caa2	3
E	caa3	Caa3	2
E	ca	Ca	1
E	c	C	0

Source: Moody's 2012b.

Figure 1 gives a schematic representation of the various components of the overall bank rating according to Moody's methodology.

Figure 1: Components of the overall bank rating according to Moody's methodology

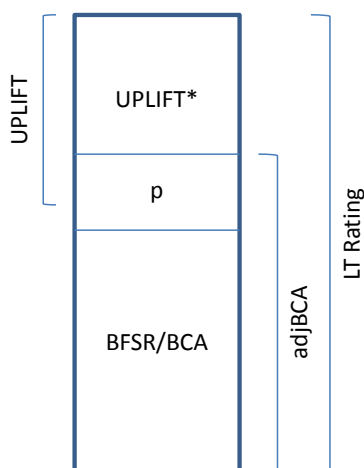

Variables created and the corresponding time periods

- a) As a first step all ratings of each individual bank are transformed into a numerical scale varying from zero to 20, with 20 describing the best rating category (see table above).⁸⁰
- b) The UPLIFT is calculated as the difference between the LT and the BCA (as they are measured in the same rating scale). However, as Moody's started publishing BCA only in 2011 for dates prior to 2011 the BFSR is employed. BFSR is then transformed into BCA according to Table 1. In cases where a specific BFSR rating corresponds to more than one BCA rating the average of those is considered (e.g. C- corresponds to the ratings Baa1 and Baa2).
- c) The UPLIFT* is calculated as the difference between the LT and the adjBCA for the period 2011-2012 (4 semi-annual observations)⁸¹.
- d) The difference between adjBCA and BCA, which can be interpreted as an implicit measure for parental support quality, is also computed.

⁸⁰ BFSR, which is only used to describe the evolution of the UPLIFT is mapped into 13 classes.

⁸¹ It must be noted that when constructing the UPLIFT* variable the following simplified assumption is made: An UPLIFT* of 1 notch is quantitatively the same irrespective of the underlying adjusted BCA and stand-alone ratings.

Appendix B presents detailed statistics for the various ratings considered for various points in time.

3.2 Descriptive statistics on the UPLIFT/UPLIFT*

Figure 2 shows the evolution over time of the BCA and the UPLIFT. Results suggest that UPLIFT is significant and has been around 3 notches throughout the period. Results are in line with previous literature⁸² and show that the stand-alone rating has decreased during the last years, while the UPLIFT is more stable. One can thus conclude that the UPLIFT represents an increasing share of the total rating and that the ratio of the UPLIFT over the individual bank strength is increasing over time. The UPLIFT peaked between 2009 and 2011.

Figure 2: Evolution of the average BCA (estimate of Stand Alone Credit Rating) and average UPLIFT over time

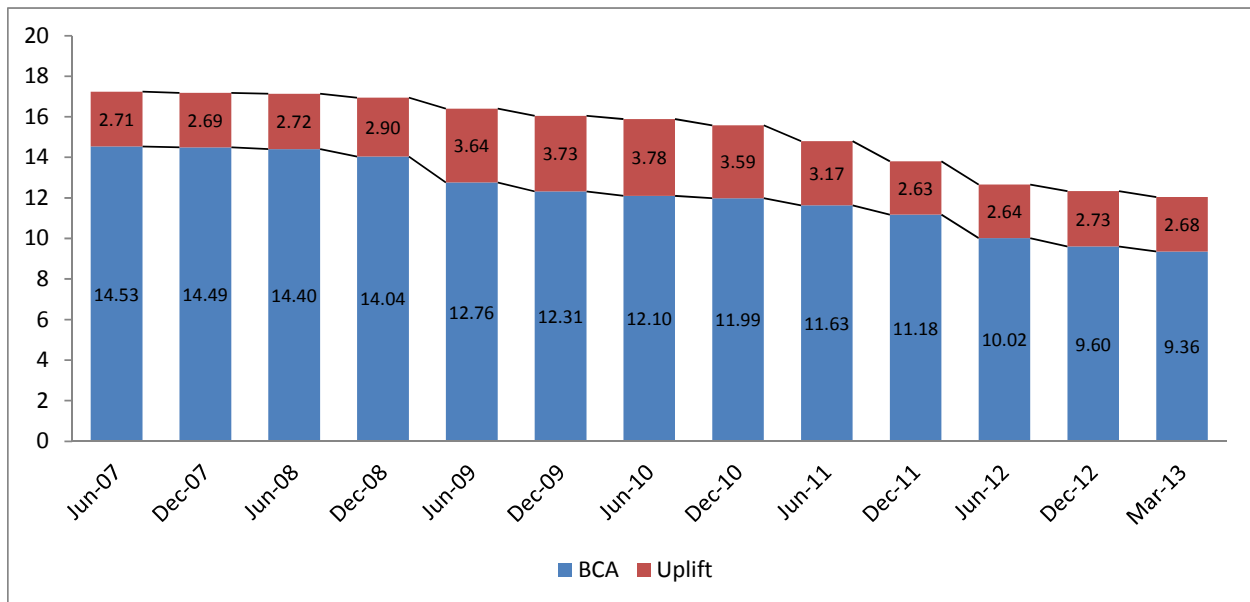

Source: Moody's and own calculations

Note: UPLIFT is estimated as the difference in notches between AICR and SACR. Prior to 2011 the BFSR to BCA mapping procedure is employed.

Table 2 presents the statistics of the UPLIFT* and

⁸² A detailed comparison of the obtained results with the existing literature can be found in Appendix C.

Figure 3 shows the evolution of the UPLIFT* for the available points in time. UPLIFT* is significant and around 2 notches in the period between June 2011 and March 2013. Note that as adjusted stand-alone rating (adjBCA) are published only since 2011, the UPLIFT* cannot be computed in earlier periods.

Table 2: Summary statistics for UPLIFT*

	# Observations	Simple Average	St. dev	min	max
June 2011	89	2.34	1.35	0	6
December 2011	104	1.91	1.33	0	7
June 2012	110	1.88	1.33	0	6
December 2012	112	1.96	1.50	0	8
March 2013	112	2.01	1.77	0	11

Figure 3: Evolution of the average adjBCA (estimate of Stand Alone Credit Rating and parental/cooperative support) and average UPLIFT* over time

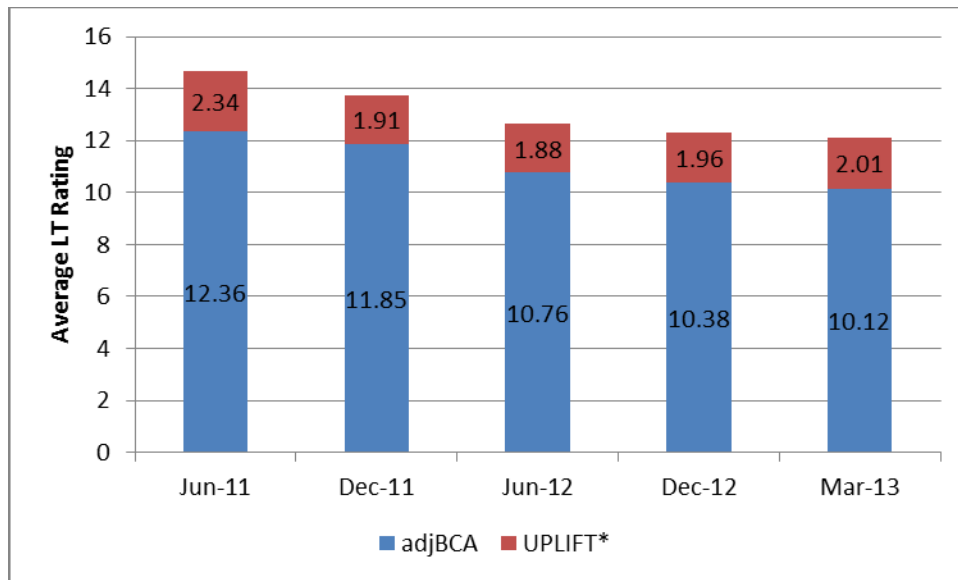

Source: Moody's and own calculations

Note: UPLIFT* is estimated as the difference in notches between AICR and SACR*.

The weighted averages of the adjBCA and UPLIFT*, which are obtained by weighing each observation according to the bank's total assets, is shown in Figure 4. Although direct comparisons across time periods cannot be made (due to small differences in the sample of banks available in the dataset in each period), one can observe that the weighted average UPLIFT* variable is greater than the simple average UPLIFT* indicating that larger banks are benefiting from a higher government support.

Figure 5 presents the contribution of the parental support (defined as the difference between the adjusted stand-alone rating (adjBCA) and the stand-alone rating (BCA)) to the long term rating. One can conclude that in contrast to the average stand-alone rating (BCA), which has decreased between June 2011 and March 2013, the average parental support has slightly increased.

Figure 4: Evolution of the weighted average adjBCA (estimate of Stand Alone Credit Rating and parental/cooperative support) and weighted average UPLIFT* over time ⁸³. March 2013 is missing since total assets are not available.

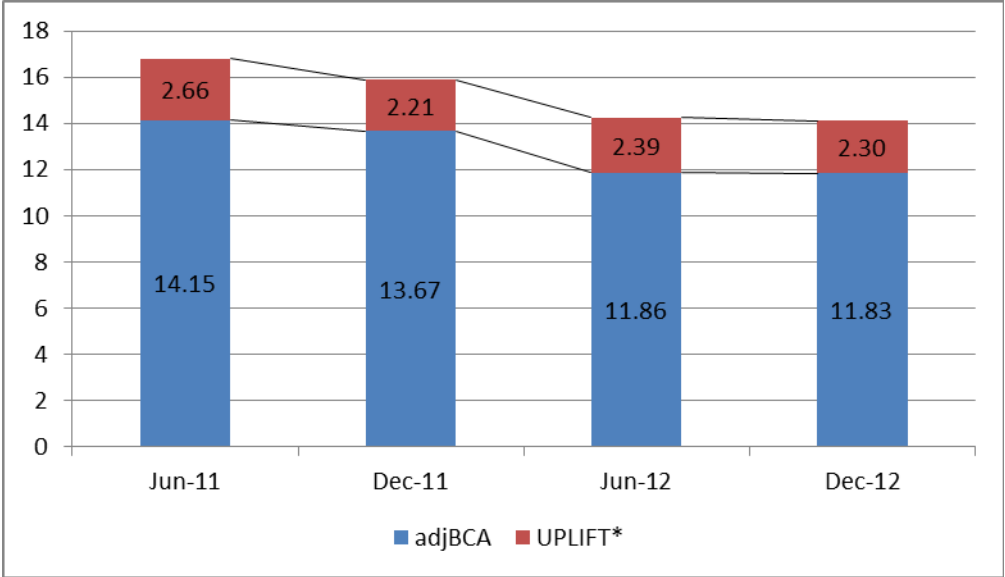

Source: SNL, Moody’s and own calculations

Note: UPLIFT* is estimated as the difference in notches between AICR and SACR*.

⁸³ Each observation of the two ratings is weighted according to the bank’s total assets.

Figure 5: Evolution of the average BCA (estimate of Stand Alone Credit Rating), average UPLIFT* and average parental support over time

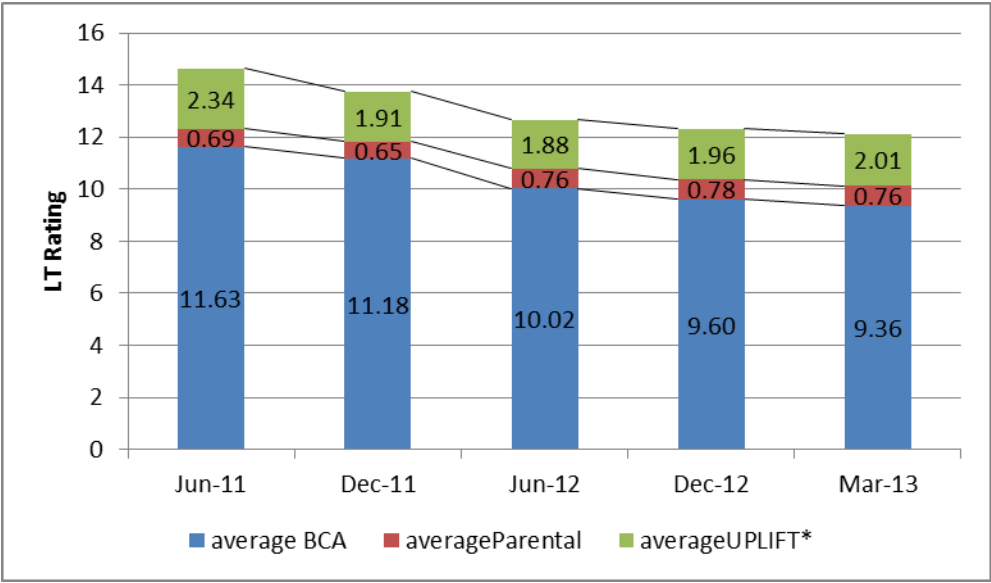

Source: Moody’s and own calculations

Note: UPLIFT* is estimated as the difference in notches between AICR and SACR*, parental support is calculated as the difference between SACR* and SACR.

The average UPLIFT* varies between countries implying different levels of support, as can be seen in

Figure 6. Belgium, France, Austria and Germany are among the countries for which the estimated UPLIFT* is consistently higher, which is in line with the findings of Schich and Lindh (2012). When comparing Member States one should consider that this analysis includes only the banks in the sample and that simple averages are provided.

Figure 7 presents the change of the average UPLIFT* between June 2011 and March 2013.

Figure 6: Simple average UPLIFT* for 23 European MS (March 2013), in notches. In parentheses one can read the number of banks in the sample for each country.

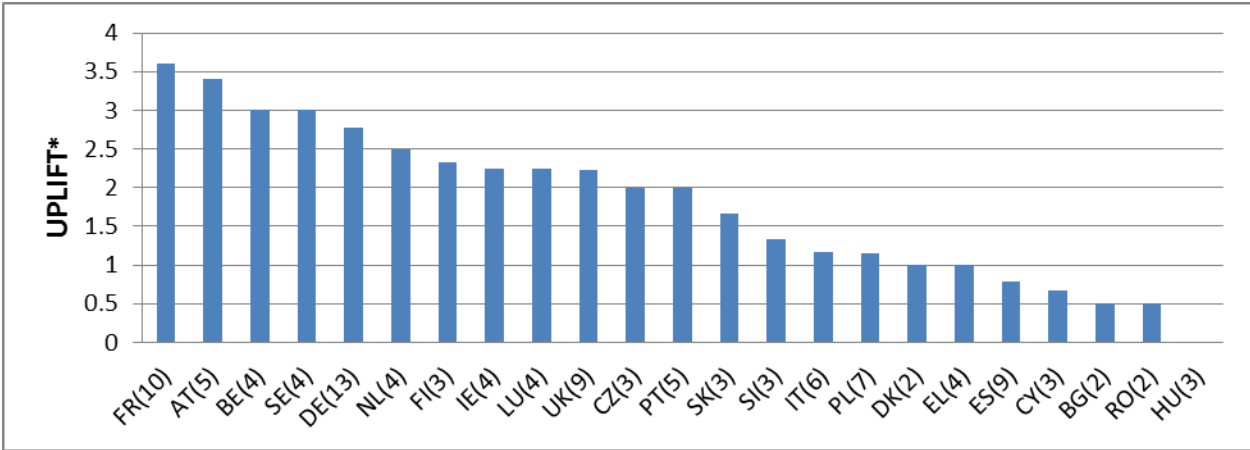

Source: Moody’s and own calculations

Note: UPLIFT* is estimated as the difference in notches between AICR and SACR*

Figure 7: Changes of average UPLIFT* between June 2011 and March 2013 for 23 European MS

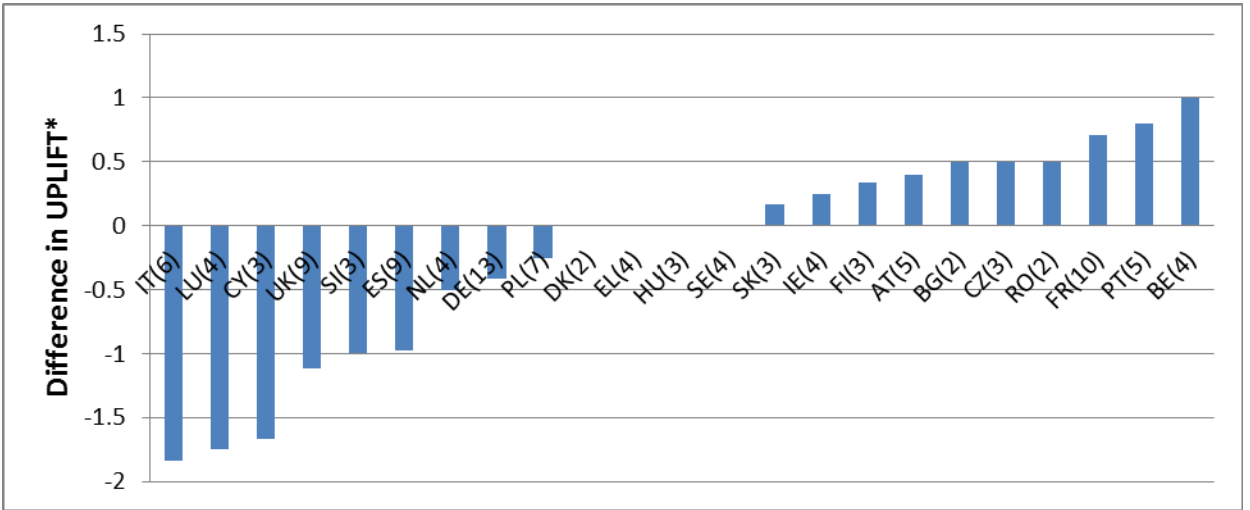

Source: Moody’s and own calculations

Note: UPLIFT* is estimated as the difference in notches between AICR and SACR*

The UPLIFT* is also higher for larger banks. The relative difference between the average UPLIFT* of the 25% largest banks in the sample and of the remaining ones is between 7% and 26%, depending on the point in time (see Figure 8). For the 10% largest banks the difference is 5% to 23% (see Figure 9). The relationship between size and UPLIFT* is better examined

through the regression analysis in Section 5, which also control for other variables that may affect the UPLIFT*.

Figure 8: Average UPLIFT* for the 25% largest banks (total assets) over time

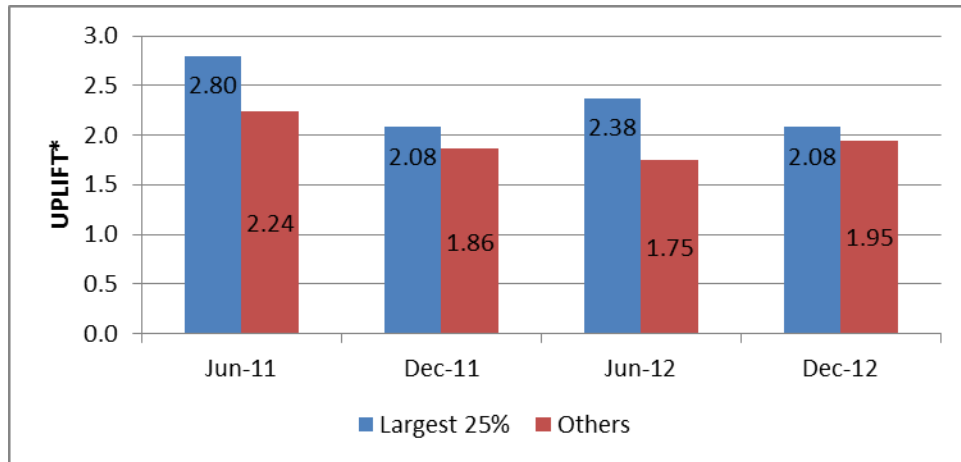

Source: SNL, Moody's and own calculations

Note: UPLIFT* is estimated as the difference in notches between AICR and SACR*

Figure 9: Average UPLIFT* for the 10% largest banks (total assets) over time

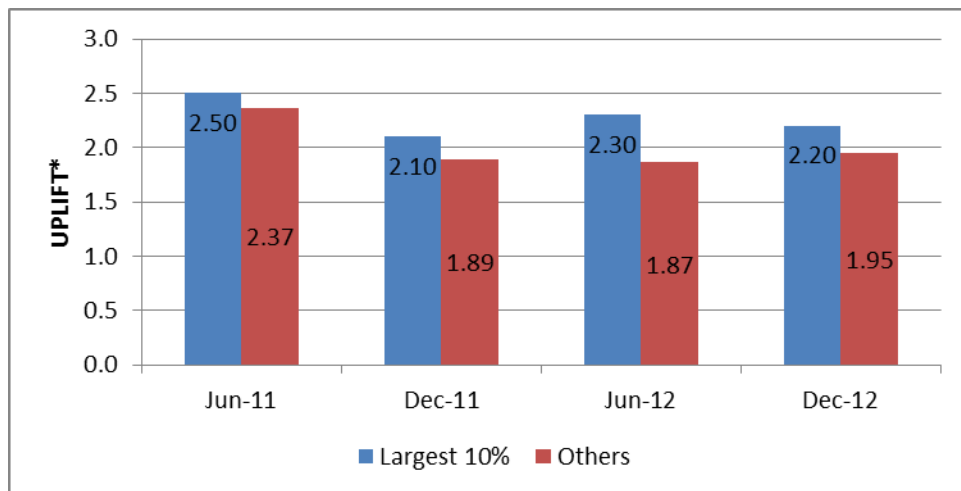

Source: SNL, Moody's and own calculations

Note: UPLIFT* is estimated as the difference in notches between AICR and SACR*

Appendix D presents scatterplots for each point in time of the UPLIFT* versus the total assets at the four different time periods. No clear discernible pattern can be identified.

Figure 10, Figure 11 and Figure 12 are scatters plots of the average UPLIFT* against the countries' sovereign rating at different points in time. There is a positive relationship between the country's sovereign rating and the UPLIFT* in all periods of the analysis. The fact that for countries such as CY, IT, ES one can observe a shift left down through time points towards a positive relationship between the two variables (see also Section 5).

Figure 10: Scatter plot of the average UPLIFT* and country's sovereign rating for June 2011

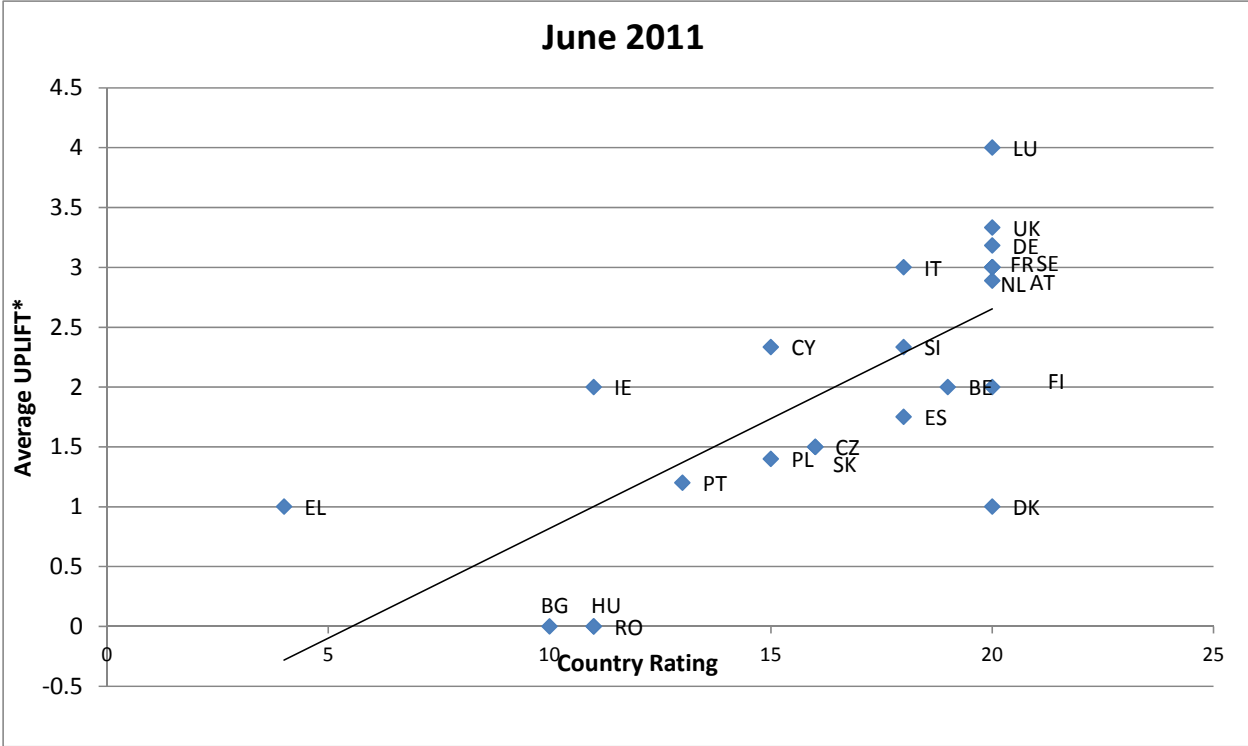

Source: Moody's and own calculations

Note: UPLIFT* is estimated as the difference in notches between AICR and SACR*.

Figure 11: Scatter plot of the average UPLIFT* and country's sovereign rating for December 2012

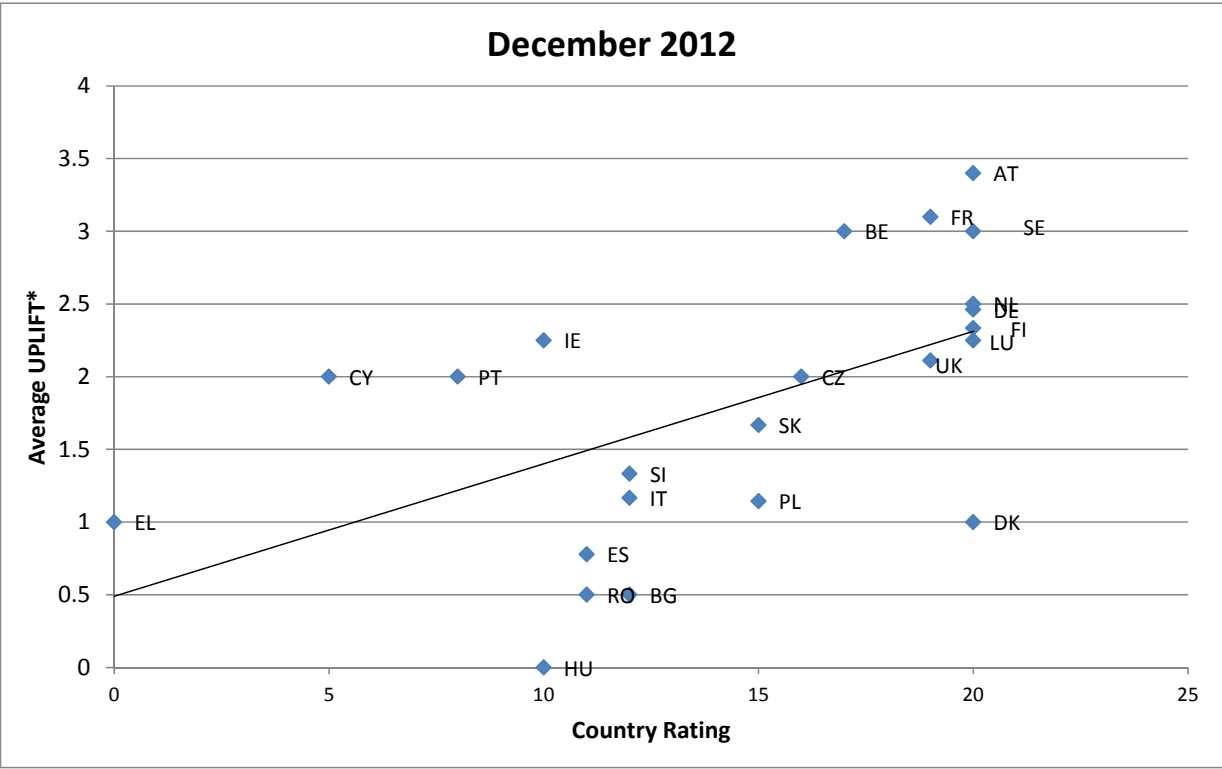

Source: Moody's and own calculations

Note: UPLIFT* is estimated as the difference in notches between AICR and SACR*.

Figure 12: Scatter plot of the average UPLIFT* and country's sovereign rating for March 2013

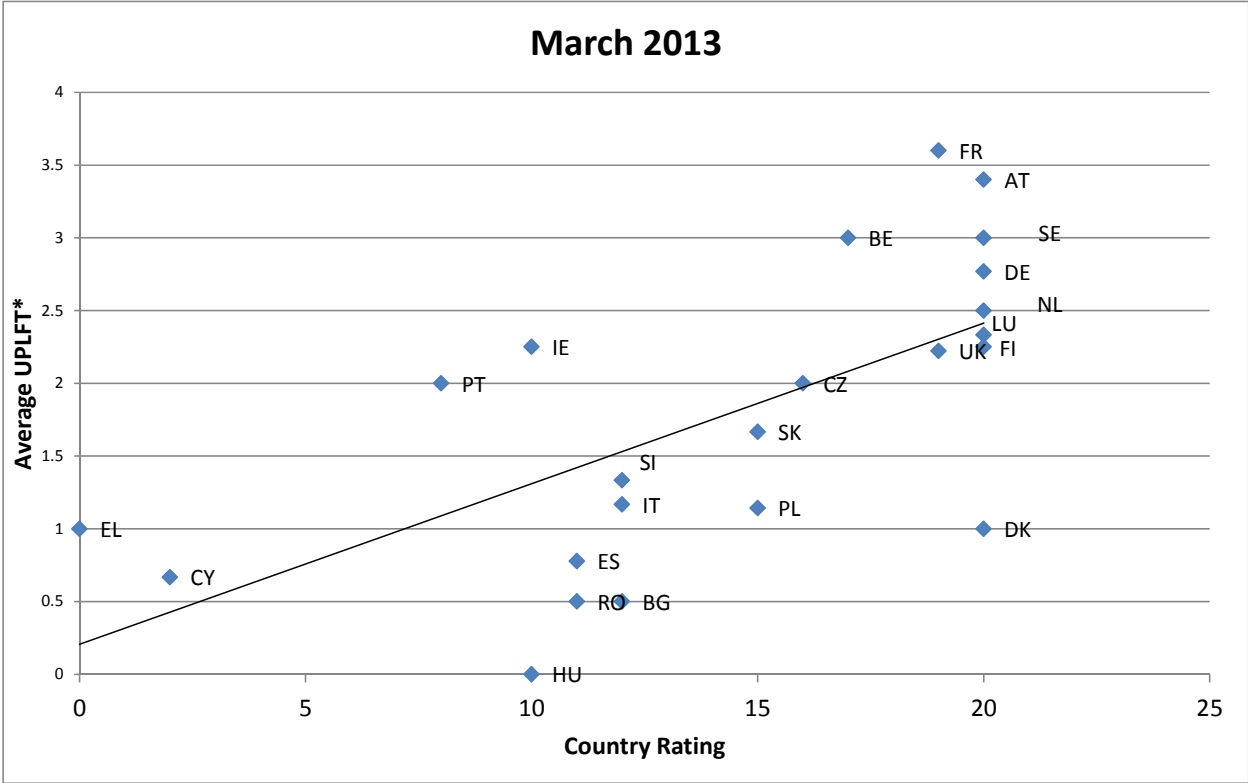

Source: Moody's and own calculations

Note: UPLIFT* is estimated as the difference in notches between AICR and SACR*

4. Estimation of the implicit subsidy

We aim at estimating the funding cost advantage of banks due to an implicit support from the sovereign where the reporting entity is headquartered, for the sample of banks used in the above analysis of the UPLIFT* based on balance sheet data for the end-of-year of 2011 and 2012.

4.1 Methodology

The estimation is done in two steps. Firstly, we compare the funding cost implied by the long-term credit rating of a bank with the counterfactual funding cost based on its stand-alone credit rating, following Schich and Lindh (2012) and Noss and Sowerbutts (2012). We assume that the difference of these two values approximates the potential funding cost advantage (in basis points) due to the implicit subsidy from the sovereign. Secondly, we multiply the funding cost advantage with a share of the outstanding debt.

To perform this analysis we use:

- The banks' adjust stand-alone rating (the adjusted BCA) and the all-in (long-term) rating;
- A rating-yield curve to map the credit ratings to yield spreads;
- A proxy of the share of each banks liabilities that can be assumed to be rating sensitive in the sense that the cost depends on the credit rating.

4.2 The rating-yield curve map

The rating-yield curve is built by taking weekly observations of market yields for a sample of European banks from 18 countries. The sample consists of 77 banks in 2011 and 82 banks in 2012⁸⁴. We have built one rating-yield curve for the second half-year of 2011 (2011H2) and one for the second half-year of 2012 (2012H2). The data used comes from DG ECFIN's Bank Watch. The yields given in the Bank Watch data are the market yields for bonds with a maturity of 5 years. Note that the sample used to build the rating-yield map and the sample used to estimate the implicit subsidy (and the UPLIFT*) is not the same. Overall 54 banks in 2011H2 and 57 banks in 2012H2 belong to both samples. A description of the sample used to build the mapping between ratings and yield spreads is given in Appendix E.

The average yield spread for each rating bucket is estimated for 2011H2 and 2012H2 and a non-linear curve is fitted to the estimated average yield spreads (see Figure 13). It can be observed that the average yield spreads (marked with diamonds) have decreased over the full spectrum of

⁸⁴ On average 72 and 80 banks per week in 2011 and 2012, respectively, due to missing values for some banks in some weeks.

rating categories from 2011H2 to 2012H2 and that the yield spread curve is flatter for the latter time period.⁸⁵

Figure 13: Rating-yield spread curve for 2011H2 and 2012H2

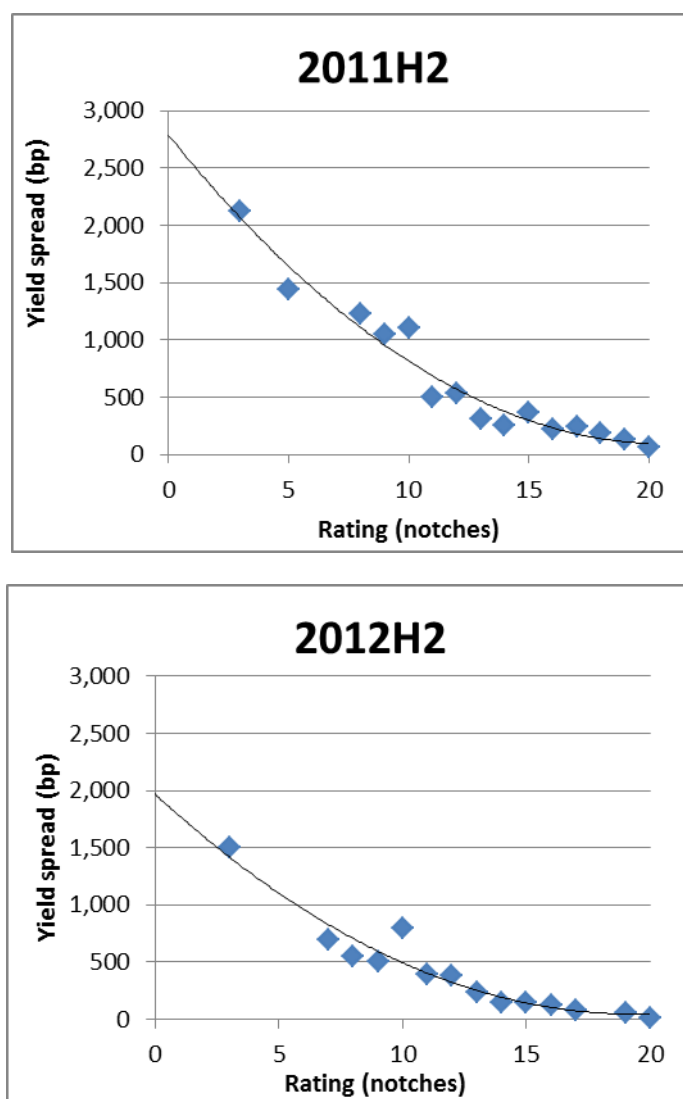

Source: DG ECFIN's Bank Watch and own calculations

Note: The diamonds indicate the average 5-year market yield spreads per rating class.

⁸⁵ The very high yield spreads for the lower ratings might be driven by the fact that there are few observations of bonds for the low notches (see Appendix E). Therefore the possibility that our estimates are not accurate is greater for such observations. However, there is also a small number of banks with low notches in the sample of the banks used for the computation of the UPLIFT* and therefore this is unlikely to lead to very significant errors in the monetary quantification of the implicit subsidies over the whole sample.

As mentioned previously, the sample used to build the rating-yield curves and the sample used to estimate the implicit subsidy overlaps partly (54 banks in 2011H2 and 57 banks in 2012H2). Thus, for these banks we can compare the average market yield spreads with the yield spreads given by our rating-yield curve mapping as presented in Figure 14.

Figure 14: Estimated yield spreads derived from long-term ratings versus average observed market yield spreads (in basis points)

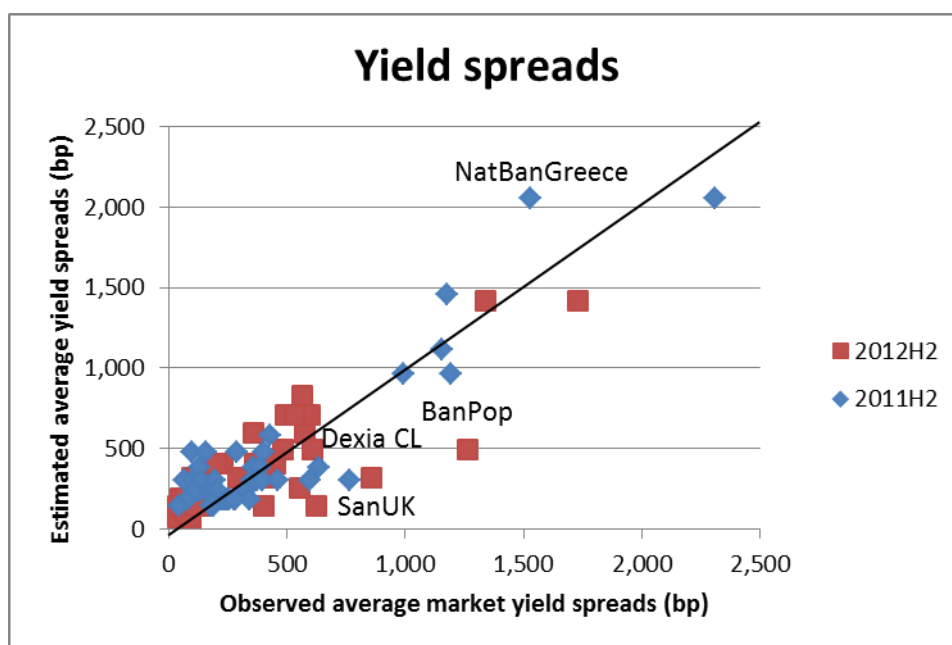

Source: Bank Watch and own calculations

From Figure 14, one can see that the average yield spreads derived from the mapping exercise and the actual market spreads are more or less in line with each other in both 2011 and 2012. For these banks present in both samples, the average market yield spreads were 21 basis points and 8 basis points lower than the yield spreads estimated from the rating-yield mapping in 2011 and 2012, respectively. This indicates that the market gave on average a higher funding advantage to these banks than our rating-yield spread map indicates, as banks were on average able to secure funding at lower yield spreads than what we predict.⁸⁶ It is therefore likely that we are slightly conservative in our estimate of the implicit subsidy

⁸⁶ Points below the straight line represent banks for which the estimated yield spreads is lower than the average market yield spreads. Points above the straight line represent cases for which the estimated yield spreads are higher than the average market yield spreads. The difference between a bank's average market yield spread and its estimated yield spread is the vertical distance between the point and the straight line.

with respect to the calculation of the yield curve. There are, however, some cases where the difference between the observed market yield spreads and the estimated yield spreads are significant.⁸⁷

From the above rating-yield spread curves we estimate the difference between the yield spreads given by using the long-term issuer rating and the yield spreads given by the adjusted BCA.⁸⁸ Scatterplots of the yield spread difference versus bank size is shown in Figure 15 and

Figure 16. Section 5 presents an econometric analysis investigating the relationship between funding advantage as measured via the yield spread difference and bank size.

Figure 15: Difference between long-term issuer (all-in) rating yield spreads and adjusted BCA (estimate of Stand Alone Credit Rating and parental/cooperative support) yield spreads in 2011H2 versus banks total assets

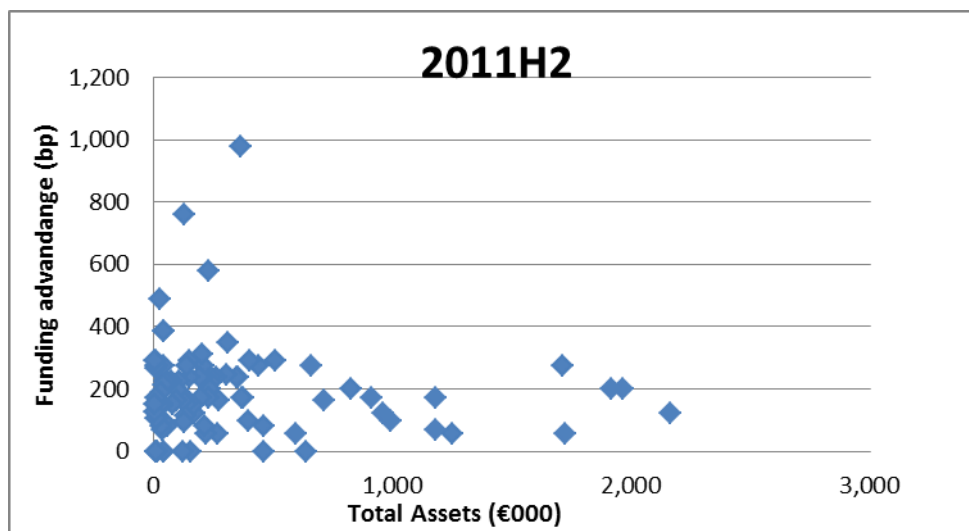

Source: Bank Watch, SNL, and own calculations.

⁸⁷ We have examined in more detail three cases where the market yield spreads are higher than the estimated yield spreads in Figure 15. Santander UK, for example, had an average market yield spread of 624 bp in 2012H2, which corresponds approximately to a Ba2 rating. The estimated yield spread based on its long-term rating (A2) is 142 bp, a difference of 482 bp compared to the average market spread. For Dexia Credit Local SA (FR) and Banco Popular Español SA (ES) the average yield spreads are 532 and 770 bp, respectively, higher than the estimated yield spreads in 2012H2. There are also cases where the average market yield spread is lower than the estimated yield spread. See, for example, National Bank of Greece SA in 2011H2, which had an average market yield spread of 1527 while the estimated yield spread is 2057.

⁸⁸ The weighted average funding cost advantage (weighted on bank's total assets) is 171 and 149 basis points for 2011 and 2012 respectively. This corresponds to an increase in the WACC of 25-35 bps, since the proxies for credit sensitive liabilities represent 15% to 20% of total liabilities (see Section 4.3).

Figure 16: Difference between long-term issuer (all-in) rating yield spreads and adjusted BCA (estimate of Stand Alone Credit Rating and parental/cooperative support) yield spreads in 2012H2 versus banks total assets

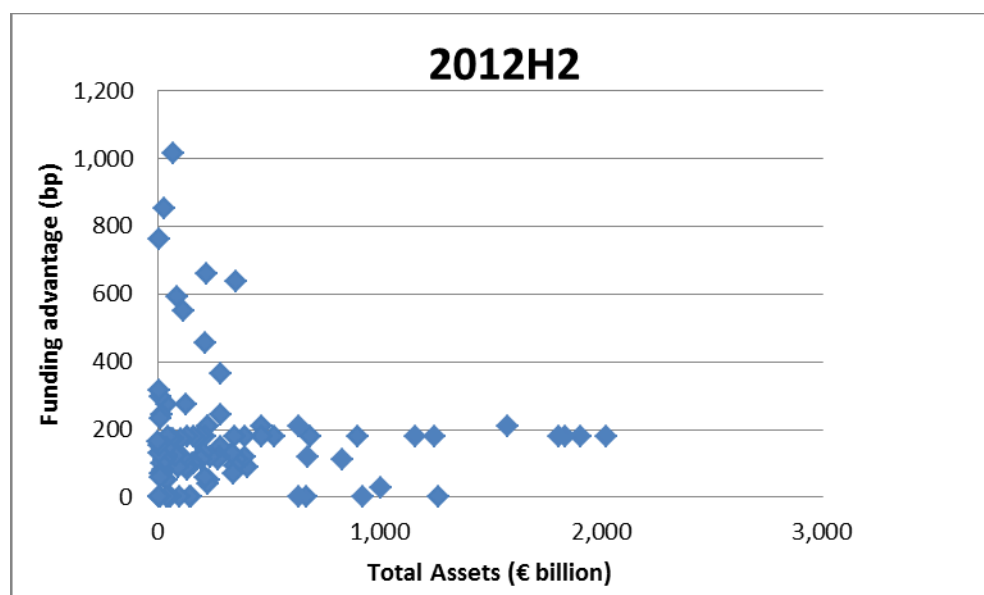

Source: Bank Watch, SNL, and own calculations.

4.3 Proxies of rating sensitive liabilities

Banks fund their activities with various sources of funding (e.g. bonds, deposits and loans) with different costs. The cost of each of these sources of funding is assumed to be influenced by the banks credit rating(s) differently. These various types of liabilities are therefore expected to benefit from any potential implicit guarantee differently. We have chosen to work with two different proxies of rating sensitive liabilities:

- ‘Total Debt’ as reported in SNL⁸⁹ (corresponding to around 20% of total liabilities); and
- ‘Total Long-term Funding’ as reported in Bankscope⁹⁰ (corresponding to around 15% of total liabilities).

A description of the sample used for estimation of rating sensitive liabilities can be found in Appendix F.

The data we are using for approximating the rating sensitive liabilities is on a consolidated basis.⁹¹ It includes, therefore, all debt issued by the reporting entity (bank holding company,

⁸⁹ In SNL, Total Debt is the sum of Total subordinated debt and Senior debt.

⁹⁰ In Bankscope, Total Long-term Funding is the sum of Senior Debts Maturing after one Year, Subordinated Borrowing and Other Funding.

⁹¹ For each large banking group we have used the highest possible consolidation level, i.e., the group head if possible. Only if the group head does not have both the long-term issuer rating and the adjusted BCA, we have

parent bank or subsidiary bank) and all of its subsidiaries which are consolidated on the reporting entity's balance sheet. This estimation should be viewed as an upper bound of a large (parent) bank's rating sensitive liabilities.^{92,93}

4.4 Implicit subsidy estimates

The total estimated implicit subsidy for the banks in the sample based on Total Debt is **EUR 95 billion and EUR 82.3 billion** in 2011 and 2012, respectively. The estimated total amount based on Total Long-term Funding is lower, **EUR 71.5 billion and EUR 58.5 billion** in 2011 and 2012, respectively, as can be expected since the Total Long-term Funding is for most banks lower than the Total Debt measure. In relative terms, the implicit subsidy estimate is 0.8% and 0.6% of EU-27 GDP for the first estimate and for the second estimate, respectively, for 2011. For 2012 the figures are lower, 0.7% and 0.5%, respectively.

Estimated implicit subsidy for the banks in the sample is presented country by country in Figure 17- Figure 20 and in Table 3. The banks in France, Germany and UK have the largest implicit subsidy estimates in absolute terms, regardless of which estimate is used (Figure 17 and Figure 19), due to the fact that many of the largest banks (measured by total assets) are headquartered in these countries and also because the relatively larger number of banks from these countries included in the sample. For France and Germany, the implicit subsidy estimates seem stable during the two periods. In most countries there is a reduction in the implicit subsidy, driven by a combination of reduction in the difference between (the adjusted) standalone yield spread and all-in yield spread and a reduction in reported total debt and long-term funding for some banks. A notable exception is Portugal, for which relatively large increases of implicit subsidy estimates can be observed (230-250% increase, respectively).⁹⁴

included the main subsidiary in the country where the group's headquarter is located. We have, for example, included HSBC Bank PLC (UK) and not HSBC Holdings PLC in the sample because the latter lacks an adjusted BCA. This will of course influence the amount of rating sensitive liabilities.

⁹² For a large bank with relatively large subsidiaries in the country where it is headquartered we have chosen not to include these subsidiaries separately when calculating the total countrywide implicit subsidy even though we have the necessary information (ratings and balance sheets). This was done in the cases of Crédit Agricole CIB (subsidiary of Crédit Agricole SA), Hypothekbank Frankfurt AG (Commerzbank AG), Deutsche Postbank (Deutsche Bank), Bank of Scotland (Lloyds TSB Bank), and National Westminster (RBS Plc).

⁹³ The use of consolidated balance sheet data might have a second caveat for cross-border banking groups. We aim at estimating the implicit subsidy due to an implicit guarantee from the sovereign where the reporting entity is headquartered, excluding any potential support from the parent bank. Consequently, for cross-border banking groups with bank subsidiaries outside their respective domestic country (i.e. where it is headquartered) the use of consolidated balance sheet data might lead to an overestimation of the implicit subsidy from the sovereign where the parent bank is headquartered.

⁹⁴ These changes in Portugal are driven by banks stand-alone and long-term ratings being downgraded, with a larger downgrade of the stand-alone rating, and, therefore, increasing the UPLIFT* from 0 to 1 notch to 0 to 4 notches. This increase in the UPLIFT*, together with the downgrade of the adjusted BCA, is translated into higher funding advantage.

When measuring the implicit subsidy relative to domestic GDP, Sweden and France (together with Portugal in 2012) are in the top, inter alia, due to the significant domestic banks' size compared to GDP in the sample (Figure 18 and Figure 20).

The results are broadly in line with other studies. However, one should be cautious when making a comparison of results across studies as differences may arise due to: differences in definition of rating sensitive liabilities, the estimation of yield spreads and the sample of banks as well as the sample period. A detailed comparison is provided in Appendix C.

Figure 17: Estimated implicit subsidy per country (EUR billion) based on Total Debt (89 banks in 2011 and 90 banks in 2012)

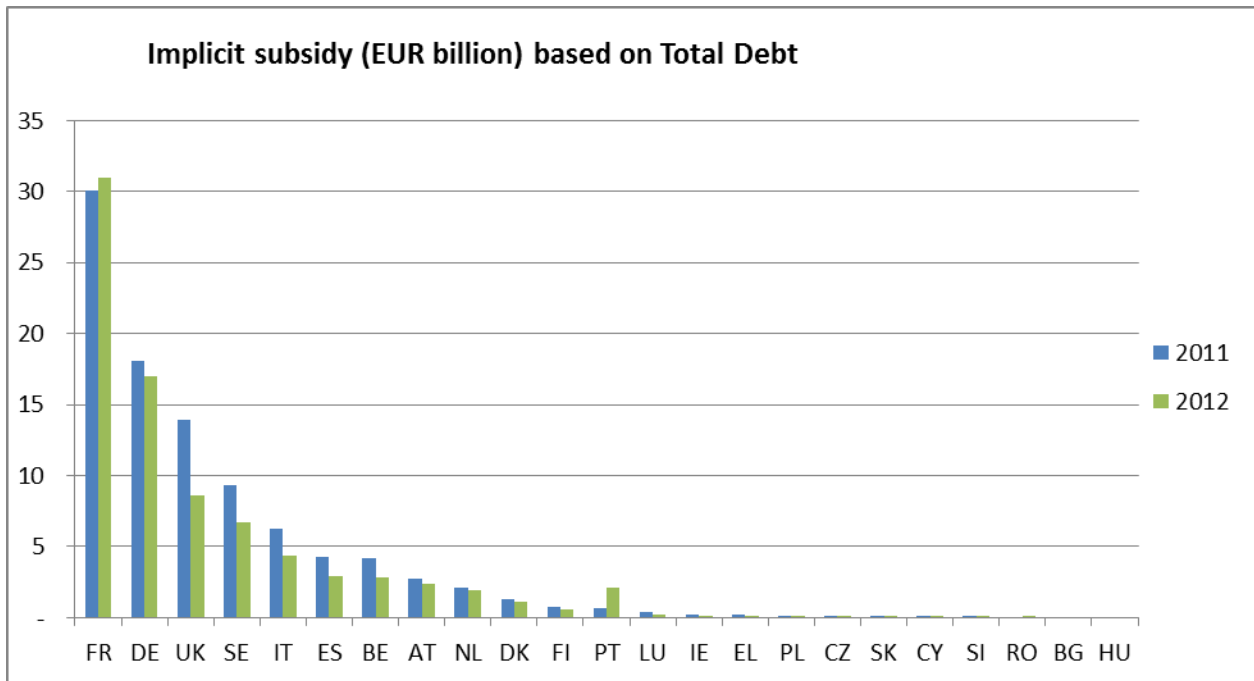

Source: Bank watch, SNL and own calculations

Figure 18: Estimated implicit subsidy per country (relative to domestic GDP) based on Total Debt (89 banks in 2011 and 90 banks in 2012)

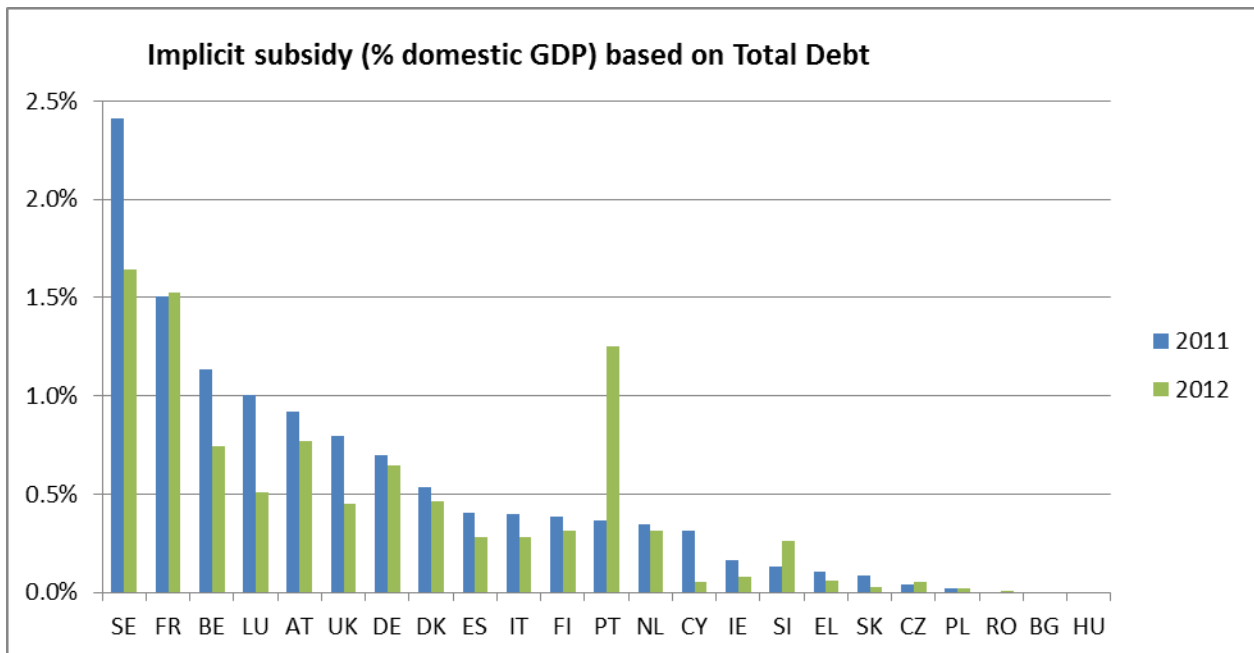

Source: Bank watch, SNL and own calculations

Figure 19: Estimated implicit subsidy per country (EUR billion) based on Total Long-term Funding (96 banks in 2011 and 102 banks in 2012)

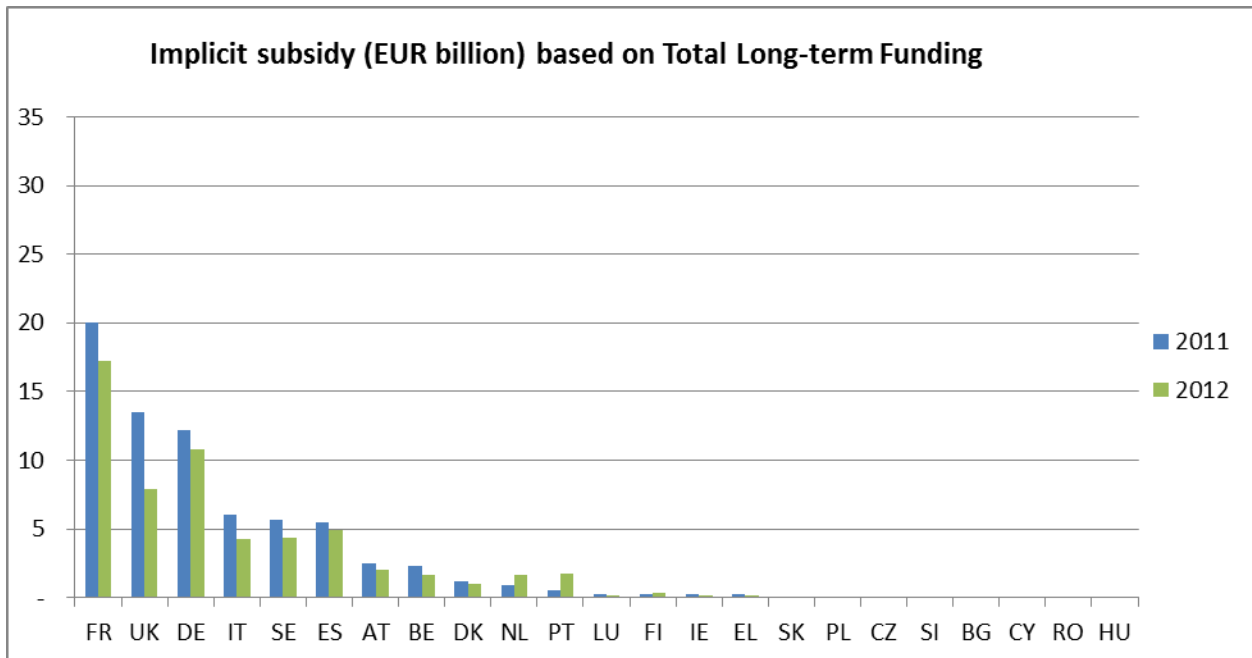

Source: Bank watch, Bankscope and own calculations

Figure 20: Estimated implicit subsidy per country (relative to domestic GDP) based on Total Long-term Funding (96 banks in 2011 and 102 banks in 2012)

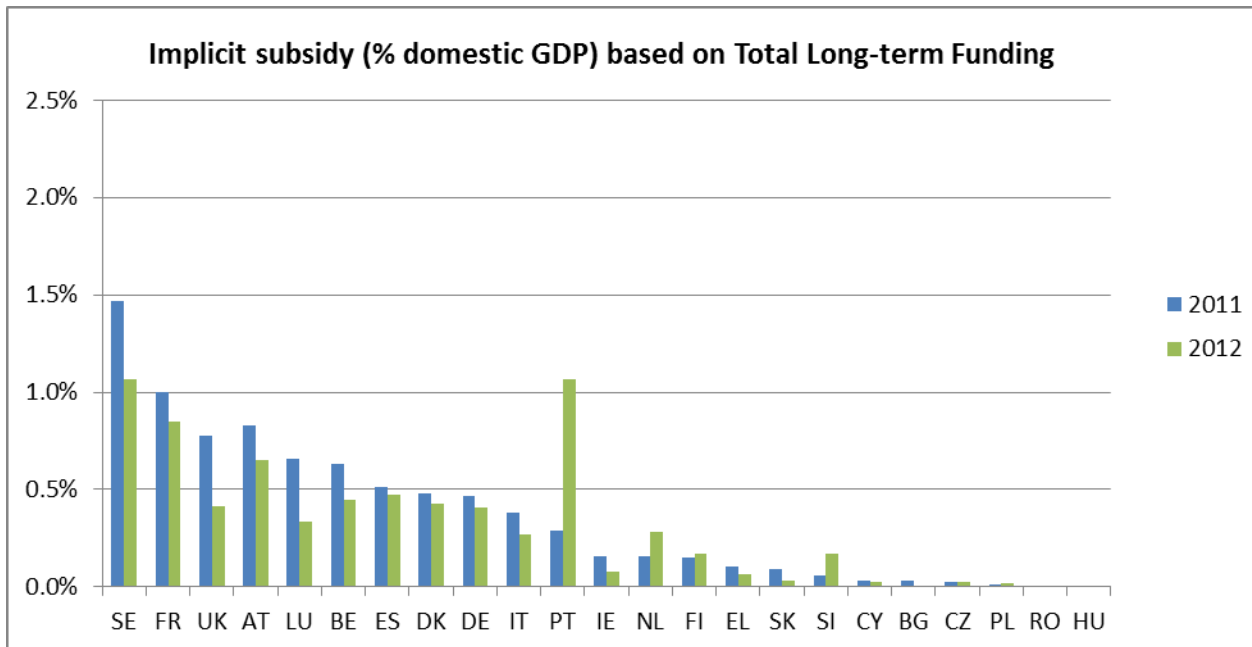

Source: Bank watch, Bankscope and own calculations

Table 3: Implicit subsidy country-by-country

Country	Implicit subsidy (EUR billion) based on Total Debt		Implicit subsidy (EUR billion) based on Total Long-term Funding	
	2011	2012	2011	2012
AT	2.8	2.4	2.5	2.0
BE	4.2	2.8	2.3	1.7
BG	0.0	0.0	0.01	0.0
CY	0.06	0.01	0.01	0.01
CZ	0.07	0.09	0.04	0.04
DE	18.1	17.0	12.2	10.8
DK	1.3	1.1	1.2	1.0
EL	0.2	0.1	0.2	0.1
ES	4.3	2.9	5.4	4.9
FI	0.7	0.6	0.3	0.3
FR	30.1	31.0	20.0	17.2
HU	0.0	0.0	0.0	0.0
IE	0.3	0.1	0.3	0.1
IT	6.3	4.4	6.0	4.2
LU	0.4	0.2	0.3	0.1
NL	2.1	1.9	0.9	1.7
PL	0.1	0.1	0.0	0.1
PT	0.6	2.1	0.5	1.8
RO	0.00	0.01	0.00	0.01
SE	9.3	6.7	5.7	4.4
SI	0.0	0.1	0.0	0.1
SK	0.1	0.0	0.1	0.0
UK	13.9	8.6	13.5	7.9

Source: SNL, Bankscope and own calculations

4.5 Comparing implicit subsidy with pre-impairment operating profit^{95, 96}

We also compare the aggregated estimated implicit subsidy with the aggregated pre-impairment operating profit. The total pre-impairment operating profit was EUR 197.5 billion and EUR 175.5 billion, in 2011 and 2012, respectively. The aggregated implicit subsidy of the sample was around 35-50% and 30-50% of pre-impairment operating profit in 2011 and 2012. These figures underline the importance of the estimated implicit subsidies as they account for a significant part of the pre-impairment operating profits of the banks. A more detailed description of the calculations and a country-by-country analysis is given in Appendix G.

4.6 Relation between implicit subsidy and bank characteristics

There is a positive relation between the size of the implicit subsidy and the size of the bank if both variables are measured in absolute terms (see Figure 21 and Figure 22). This could be expected since a large bank would have a larger amount of debt. Comparing the ratio of the implicit subsidy relative to the bank's total assets, such a positive relation is not discernible (see Appendix H).

We have investigated also the relation between implicit subsidy and various bank characteristics (leverage, share of total assets held for trading, Tier1 capital and RWA) and found no apparent pattern. Graphs are provided in Appendix H.

⁹⁵ The sample used here is slightly smaller than the full sample, since some banks are not in SNL which implies that we do not have data for the pre-impairment profit. Most notably we have excluded Barclays Bank PLC and Standard Chartered Bank in the UK.

⁹⁶ Pre-impairment profit equals operating income less operating expenses. Operating income is the total operating income from banking, insurance and asset management. It is the sum of net interest income, net fee and commissions, net insurance income, net trading income and other operating incomes. Operating expenses is the total operating expenses from banking, insurance and asset management. It is mainly personnel expenses.

Figure 21: Implicit subsidy versus total assets (end of 2011)

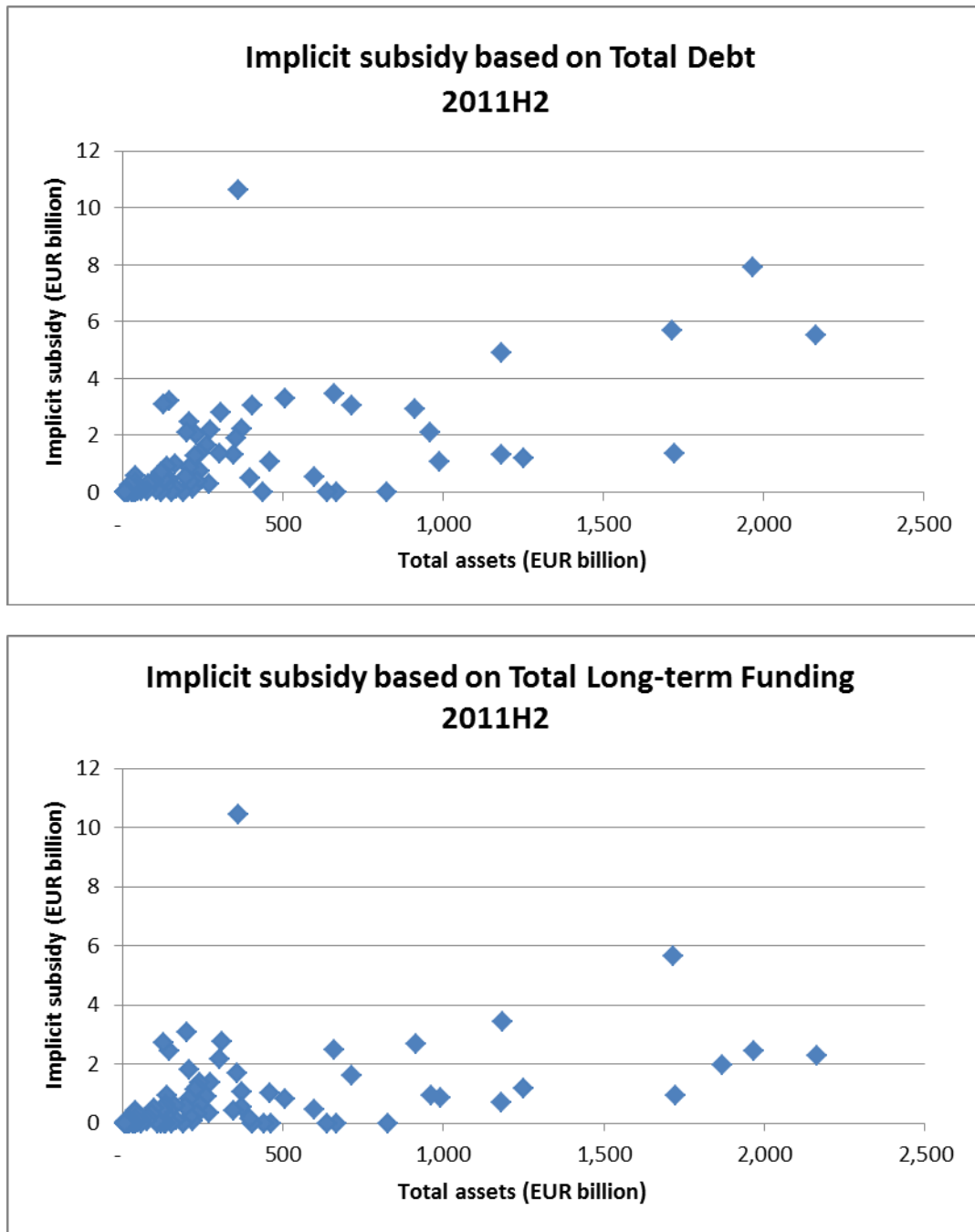

Source: Bank Watch, SNL and own calculations

Note: The outlier at the top left is Dexia Credit Locale SA.

Figure 22: Implicit subsidy versus total assets (end of 2012)

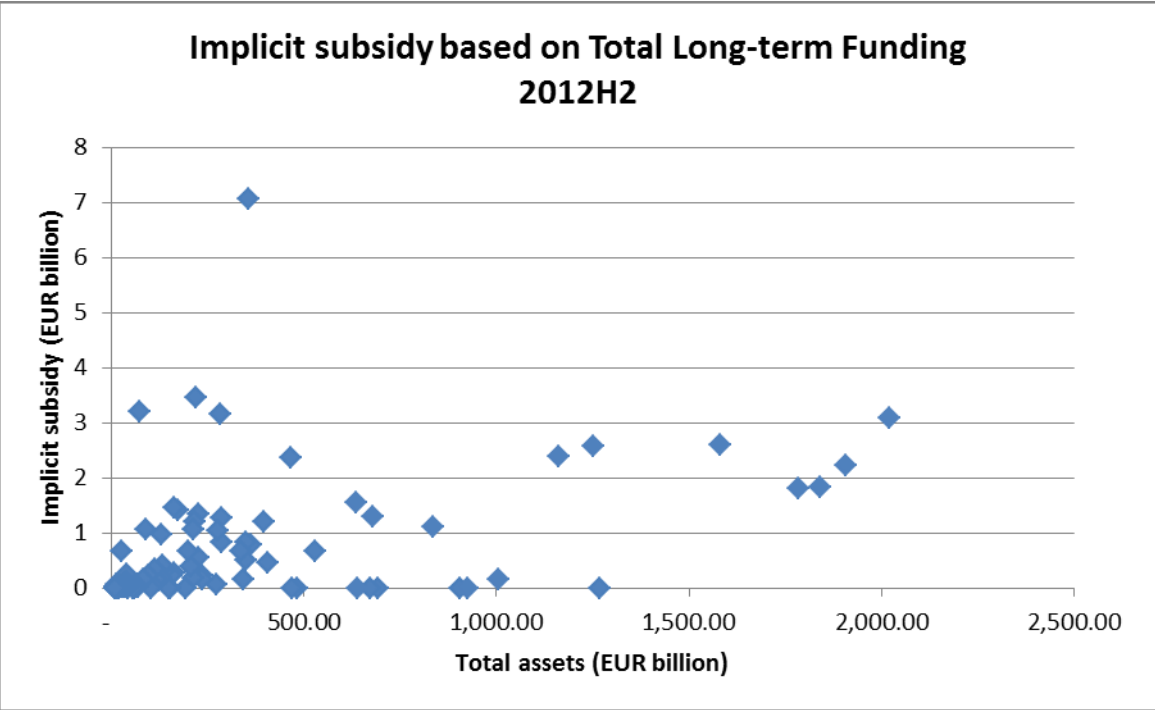
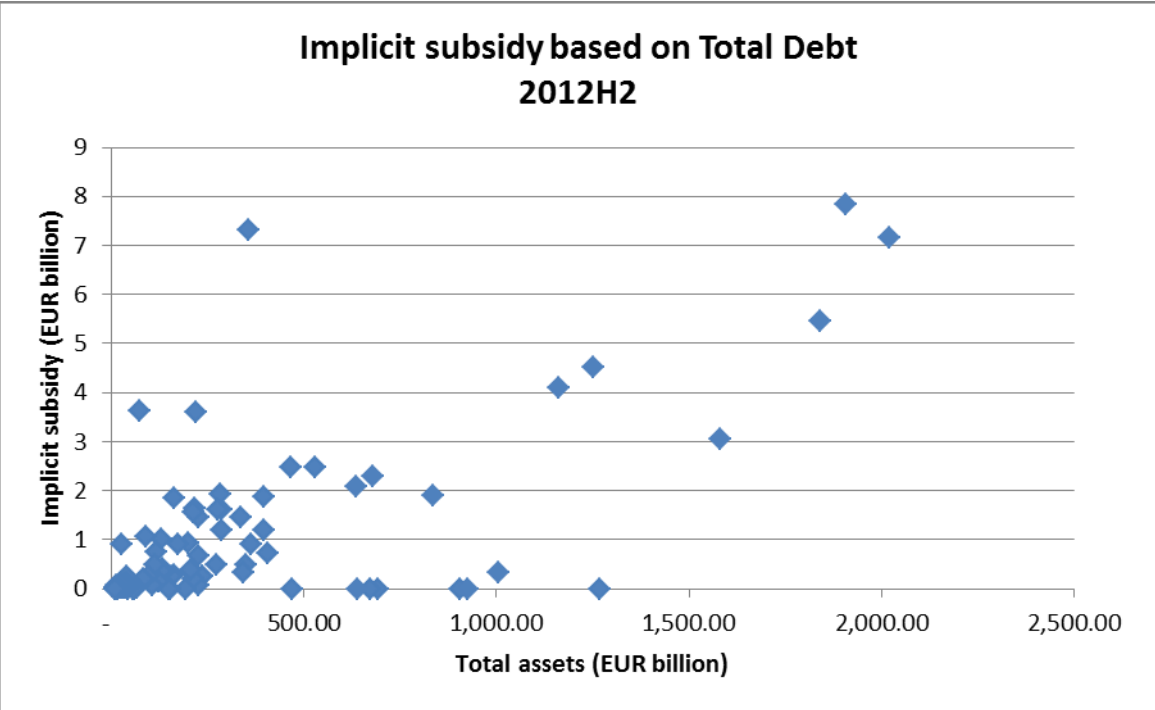

Source: Bank Watch, SNL and own calculations

5. Determinants of the implicit guarantee

Our objective is to test the following three hypotheses:

- The implicit guarantee is larger in EU countries with high sovereign ratings. Governments with higher ratings should be in a better position for providing support to the banking sector.
- For a given stand-alone rating, the implicit guarantee is greater for large banks. Large banks are often considered TBTF and therefore could be more likely to benefit from an implicit state support.
- The business profile has an impact on the implicit guarantee. Retail-oriented, wholesale and investment banks may have benefitted from a different implicit subsidy.

These hypotheses are checked via significance tests in Probit regressions. We shall verify that the model confirms the expectation that weak banks with low stand-alone rating and weak parental support receive a larger implicit subsidy compared to strong banks.

Section 5.1 describes our dataset, Section 5.2 details the econometric methodology, Section 5.3 present the empirical results for the first two hypotheses about the sovereign rating and the bank size. Section 5.4 reports results about the effect of the business profile.

5.1 Dataset and explanatory variables

Our database is made up of Moody's ratings for 112 EU banks for four semesters over the years 2011-2012. The implicit guarantee is reflected in the UPLIFT*. This variable is obtained as the difference between the long-term and the stand-alone rating that Moody's assigns to each bank. The long-term rating takes into consideration the possibility of a government support. The bank stand-alone rating is measured by Moody's Baseline Credit Assessment (BCA) variable. Moody's also makes available a stand-alone rating that includes the possibility of a parental support (adjBCA). We use the difference P between these two variables as an indicator of the parental support quality, i.e. $P = \text{adjBCA} - \text{BCA}$. Moody's rating of the sovereign debt is labelled Sov.

The banks in our dataset have received an UPLIFT* from 0 to 7 notches. The empirical distribution of the UPLIFT* is displayed in Table 4 below whereas the cumulative distribution is shown in Figure 23.

Table 4: Empirical distribution of the UPLIFT* for 112 EU banks over 2011-2012

UPLIFT*	0	1	2	3	4	5	6	7
Frequency	15%	24%	23%	29%	4%	4%	1%	1%

Figure 23: Cumulative density function of the UPLIFT* over 2011-2012

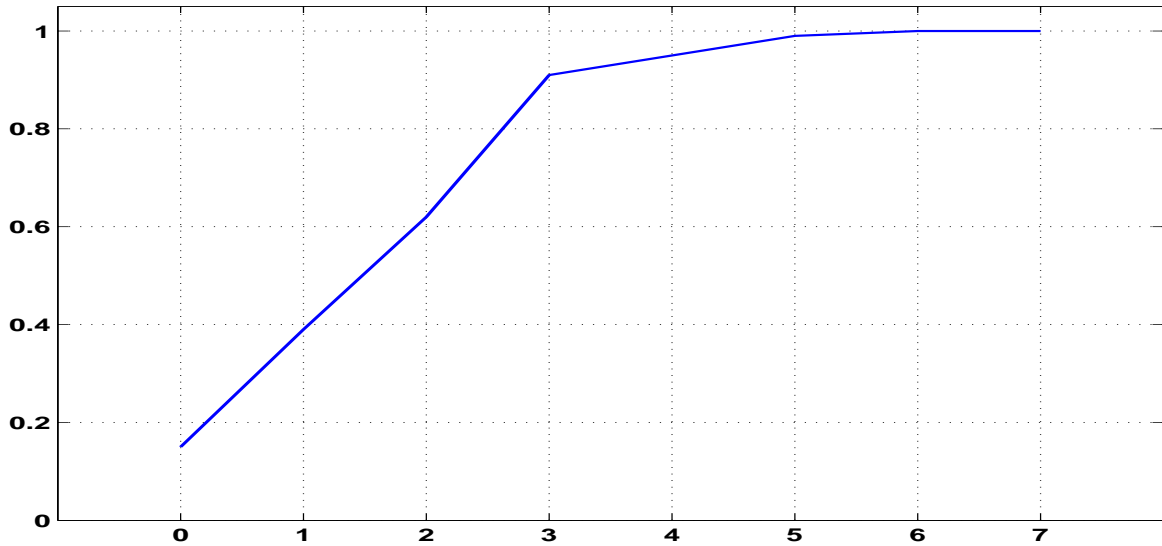

Box-plots of BCA, P, and Sov according to each UPLIFT* category are displayed in Figure 24 below. One can observe that banks with relatively low stand-alone and parental support enjoy high levels of UPLIFT*. Similarly banks headquartered in countries with high sovereign ratings enjoy a higher UPLIFT*.

Figure 24: Box-plots for stand-alone rating (BCA), parental support rating (P) and sovereign debt rating (Sov)

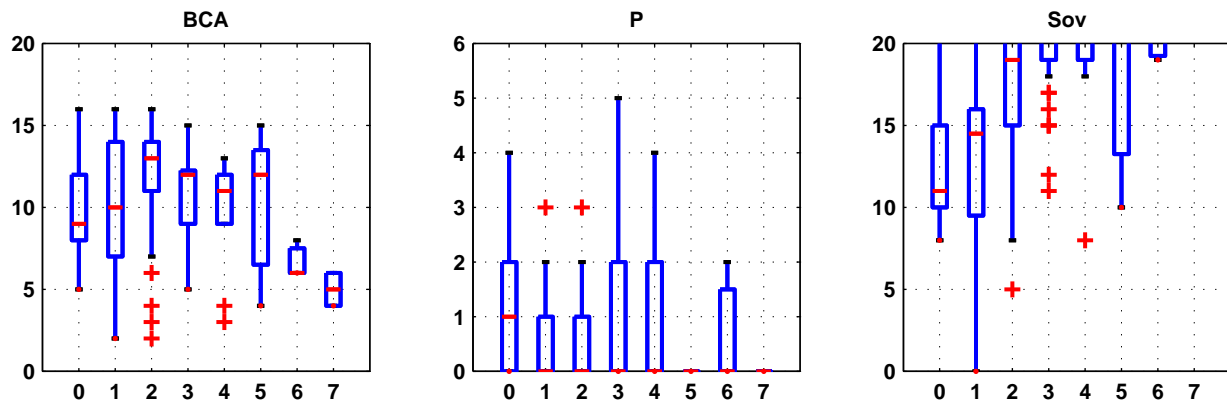

Notes: in the Box-plots the central mark corresponds to the median, the edges of the box are the 25th and 75th percentiles, and the red crosses point to outliers.

The banks size and profile are described using publicly available balance sheet information collected from the SNL database. The currency unit is euro.

The bank size is measured by the logarithm of the total assets, $\log TA = \text{logarithm}(\text{Total Assets})$.

Following existing literature (see Ayadi et al. 2012, Blundell-Wignall and Roulet, 2013 and IMF, 2013), we describe the bank business profile using the following variables:

1. AHTTA: the ratio of assets held for trading to total assets.
2. STFTA: the ratio of short-term funding to total assets.
3. DEPCTA: the ratio of customers deposits to the total assets.
4. NETLOANSCTA: the share of net loans to customers in total assets.
5. DEPBT A: the ratio of bank deposits to the total assets.
6. NETLOANSBT A: the share of net loans to banks in total assets.
7. WR: the wholesale funding ratio calculated by dividing Total Financial Liabilities minus Customers Deposits by Total Financial Liabilities. This measures the share of funding coming from the wholesale market.
8. FeeToOpInc: the ratio of net fees and commissions to operating income.
9. NetToOpInc: the ratio of net interest income to operating income.
10. DEVToFL: the ratio of derivatives liabilities to total financial liabilities.
11. TOTDERTA: Derivatives assets plus derivatives liabilities compared to total assets.
12. EquiTA: the ratio of total equity to total assets.
13. RWATA: the ratio of risk-weighted- assets to total assets.
14. T1RWA: Tier 1 ratio, which is the amount of Tier 1 capital over risk-weighted-assets.
15. T1T2RWA : Tier 1 plus Tier 2 ratio.

Broadly speaking, investment-oriented banks are characterized by high volumes of assets held for trading and gross market value of derivatives compared to their total assets (AHTTA and TOTDERTA). Accordingly, the ratio of derivatives liabilities to total financial liabilities (DEVToFL) is expected to be high. Market operations make net fees and commissions contribute significantly to the operating income (FeeToOpInc).

Wholesale banks are highly inter-connected with other financial institutions. They are thus characterized by a large share of bank loans in their total assets (NETLONSBTA) and of bank deposits in their liabilities (DEPBTA). They are expected to have a large wholesale funding ratio (WR). They should rely relatively more on short-term funding (STFTA), which has been identified as having played a key role in the financial crisis.

Retail banks have a relatively high share of customer loans in their total assets (NETLOANSCTA) and of customer deposits in their liabilities (DepCTA). Net interest income (NetToOpInc) is expected to contribute significantly to their operating income.

The ratio of total equity to total assets (EquiTA) is a simple proxy for leverage: risk-averse banks are characterized by a high level of total equity compared to their total assets.

Finally, we include two regulatory capital ratios: Tier 1 ratio (T1RWA) and total regulatory capital ratio (T1T2RWA). We also consider the average risk-weighted assets (RWATA) which should reflect the risk profile of the bank as measured by the Basel regulation, although some

researchers have questioned the appropriateness of RWATA as risk-indicator (see Blundell-Wignal and Atkinson, 2011, and Ayadi et al., 2012). For instance Ayadi et al. (2012) consider RWATA to be a good indicator of the underlying risk for both wholesale and retail banking but not for investment banks. One possible reason they put forward is that investment banks may perform regulatory arbitrage through RWATA optimization.

These variables, together with logTA, are displayed in Figure 25 and Figure 26 in the next two pages.⁹⁷

Figure 25: Box-plots for various balance sheet indicators

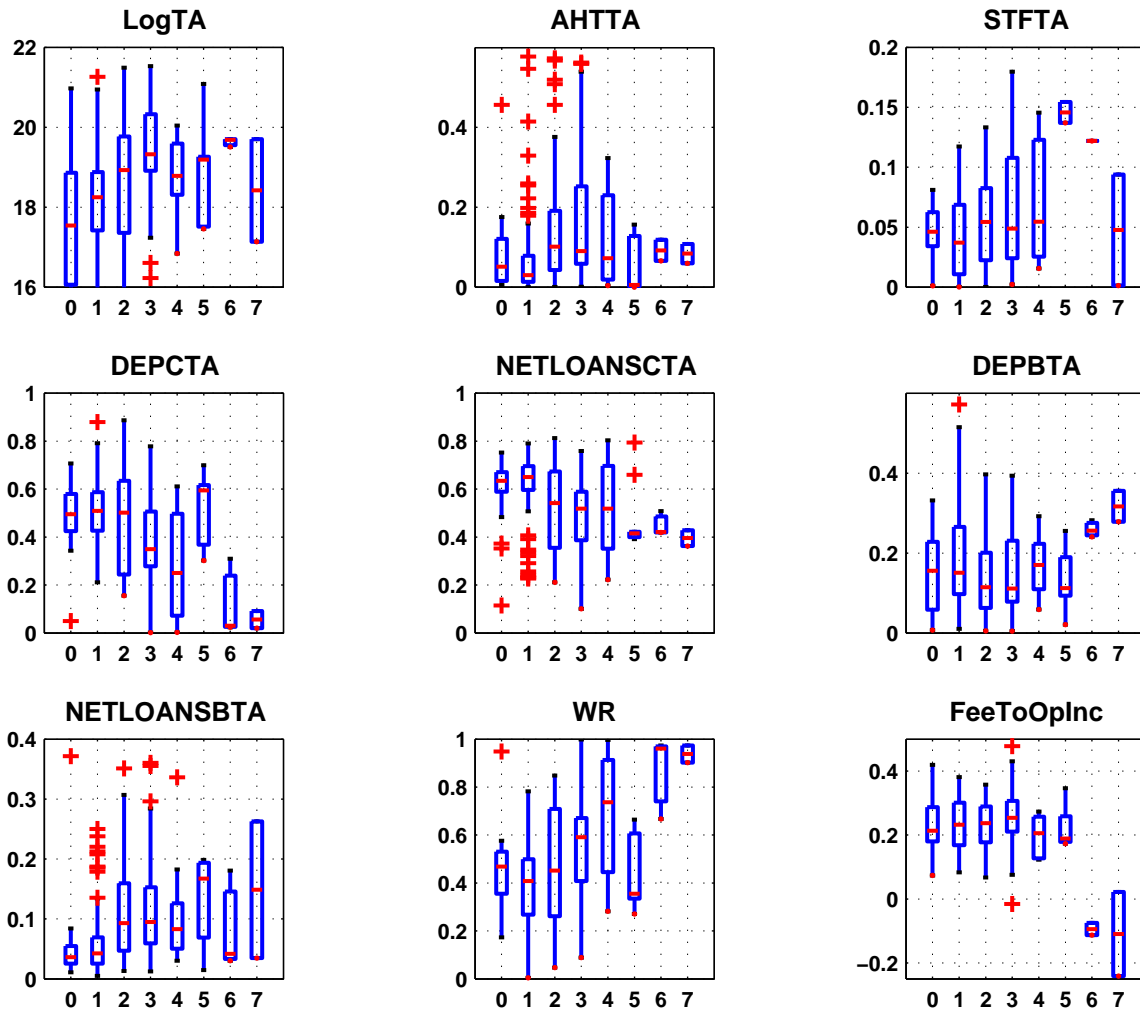

Notes: logTA: logarithm of total assets; AHTTA: assets held for trading as a share of total assets; RWATA: risk-weighted assets as a share of total assets; STFTA: short-term funding as a share of total assets; DepCTA: customer deposits as a share of total assets; NETLOANSCTA: net loans to customers as a share of total asset; DepBTA: bank deposits as a share of total assets; NETLOANSBTA: net loans to banks as a share of total asset; WR: wholesale funding ratio. In the box-plots the central mark corresponds to the median, the edges of the box are the 25th and 75th percentiles, and the red crosses point to outliers.

⁹⁷ These variables have been computed using SNL data. Appendix A gives a detailed description on the employed variables.

Figure 26: Box-plots for various balance sheet indicators

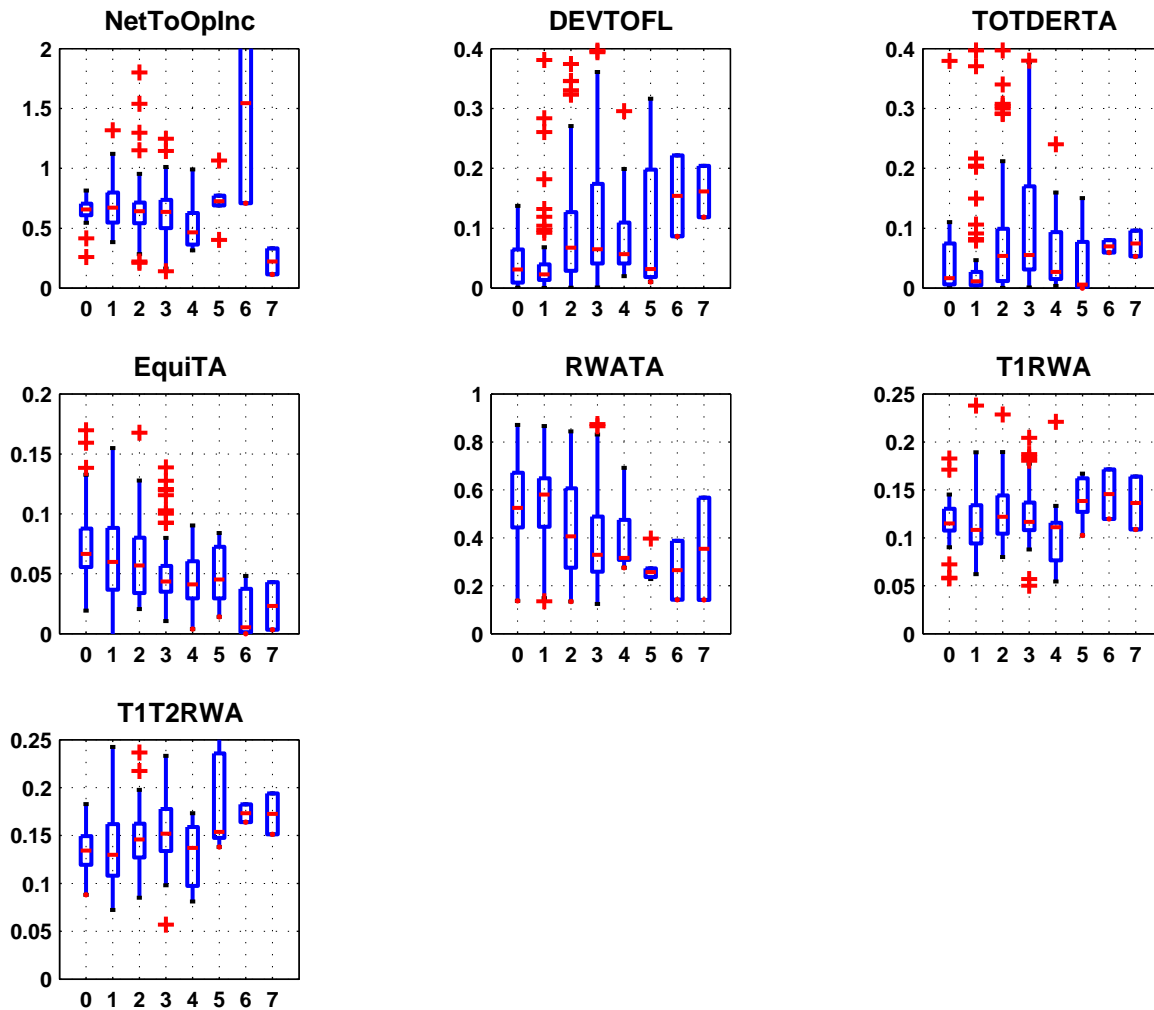

Notes: FeeToOpInc: the ratio of net fees and commissions to operating income; NetToOpInc: the ratio of net income to operating income; DEVTOFL: the ratio of derivatives liabilities to total financial liabilities; EquiTA: total equity over total assets; TOTDERTA: total derivatives in proportion of total assets; T1RWA: Tier 1 ratio; T1T2RWA: Tier 1 plus Tier 2 ratio. In the box-plots the central mark corresponds to the median, the edges of the box are the 25th and 75th percentiles, and the red crosses indicate outliers.

The box-plots in the two figures suggest that:

- The larger the log of total assets, the larger the UPLIFT*.
- A high share of asset held for trading to total assets ratio (AHTTA) tends to be associated with an UPLIFT* equal to 2, 3, or 4.
- High values of risk-weighted assets to total assets (RWATA) tend to be associated with a low UPLIFT*.
- The lower the share of customer deposits in total assets (DEPCTA) the larger the UPLIFT*.
- High proportions of net loans to customers in total assets (NETLOANSCTA) tend to be associated with a low UPLIFT*.
- The larger the proportion of net loans to banks in total assets (NETLOANSBTA) the larger the UPLIFT*.
- The larger the wholesale funding ratio (WR) the larger the UPLIFT*.
- Large ratios of derivatives liabilities to total financial liabilities (DEVToFL) seem to be associated with a large UPLIFT*.
- Larger amounts of total equity compared to total assets (EquiTA) are associated with a smaller UPLIFT*.
- Large amounts of derivatives assets plus derivatives liabilities compared to total assets (TOTDERTA) seem to be predominantly associated with an UPLIFT* equal to three notches.

For short-term funding (STFTA), banks deposits (DepBTA), net fees and commissions to total income ratio (FeeToOpInc), net interest income to operating income ratio (NetToOpInc), and the two regulatory variables (T1RWA and T1T2RWA), no systematic impact on the UPLIFT* can be read.

Some of these variables are highly correlated (>0.80): asset held for trading to total assets (AHTTA) and derivatives assets plus derivatives liabilities to total assets (TOTDERTA) at 0.93, AHTTA and derivatives liabilities to total financial liabilities (DEVToFL) at 0.88, customer deposits to total assets (DEPCTA) and wholesale funding ratio (WR) at -0.99, TOTDERTA and DEVToFL at 0.96, as well as the two regulatory capital ratio (T1RWA and T1T2RWA) at 0.90. Although not reported in the variable list, also the logarithm of total deposits is correlated with the logarithm of total assets at 0.96. Since regression analysis does not allow to discriminate between two explanatory variables that are so highly correlated, we shall not use simultaneously any two of these variables.

5.2 Econometric methodology

The dependent variable $UPLIFT_i^*$, $i=1,\dots,N$, belongs to 8 categories that for convenience we index with value $j=0,\dots,m$. Since our dependent variable is ordinal with several outcomes, we fit an ordered Probit model. Grouping the explanatory variables into the vector x_i , we define the latent variable y_i^* such as:

$$\begin{aligned} UPLIFT_i^* = 0 & \text{ if } y_i^* = x_i' \beta + \varepsilon_i < \mu_1 \\ UPLIFT_i^* = j & \text{ if } \mu_j < y_i^* = x_i' \beta + \varepsilon_i < \mu_{j+1} \quad j=1,\dots,m-1 \\ UPLIFT_i^* = m & \text{ if } \mu_m < y_i^* = x_i' \beta + \varepsilon_i \end{aligned}$$

where the constants μ_1, \dots, μ_m , are the cut-offs. The Probit model assumes that the shocks ε follow a standard normal distribution. Under this assumption the probability that the $UPLIFT^*$ for bank i falls into category j is equal to:

$$\begin{aligned} P(UPLIFT_i^*=0|x_i) &= P(y_i^* < \mu_1) = \Phi(\mu_1 - x_i' \beta) \\ P(UPLIFT_i^*=j|x_i) &= P(\mu_j < y_i^* < \mu_{j+1}) \\ &= P(\mu_j < x_i' \beta + \varepsilon_i < \mu_{j+1}) \\ &= P(\mu_j - x_i' \beta < \varepsilon_i < \mu_{j+1} - x_i' \beta) \\ &= \Phi(\mu_{j+1} - x_i' \beta) - \Phi(\mu_j - x_i' \beta) \\ P(UPLIFT_i^*=m|x_i) &= P(\mu_m < y_i^*) = 1 - \Phi(\mu_m - x_i' \beta) \end{aligned}$$

where $\Phi()$ represents the standard normal cumulative distribution. The likelihood function is such as:

$$P(UPLIFT_1^*, \dots, UPLIFT_N^* | x_1, \dots, x_N) = \prod_{i=1}^N \prod_{j=0}^m P(UPLIFT_i^*=j|x_i)^{\mathbf{1}(UPLIFT_i^*=j)}$$

where $\mathbf{1}(UPLIFT_i^*=j)=1$ if $UPLIFT_i^*=j$ and 0 otherwise. The probability $P(UPLIFT_i^*=j)$ is given in the previous system of equation. Maximizing the likelihood function gives estimates of the coefficients β as well as of the cut-off values μ_1, \dots, μ_m .

The hypothesis of independent ε -shocks implies that the $UPLIFT^*$ assigned to a bank given its own characteristics and the rating of the country where it is headquartered does not depend neither on the rating of the other countries nor on the profile of the other banks. In other words, the model considers that Moody's evaluates EU banks one by one and not altogether at the same time.

5.3 Empirical results without business model variables

Our first model relates the UPLIFT* to the stand-alone rating, the parental support, the sovereign debt rating, and the bank size. Business model variables are left out in this preliminary round. Putting together data for the two semesters of 2011 and 2012 gives a maximum number of 448 observations. Because the variables have missing values at different places, in each regression the effective number of observations depends on the subset of variables selected. The Probit regression results are described in Table 5.

Table 5: Model 1, N=364 observations

Variable	Coefficient	t-statistics
Stand-alone rating (BCA)	-.382	-12.12
Parental support (P)	-.549	-8.69
Sovereign rating (Sov)	.367	15.03
Size of bank (logTA)	.230	5.37
Log-lik	-426.55	
Log-lik/N	-1.17	

The cut-offs are estimated as $(\mu_1, \dots, \mu_7) = (3.75, 5.22, 6.30, 7.93, 8.34, 9.18, 10.09)$ with standard error around 0.80. Table 6 also reports the log-likelihood and the average log-likelihood by observation at the aim of model comparison. Model 1 fit is shown in Table 6 below. It reports the empirical distribution of UPLIFT* over the 364 observations used in Model 1 together with the unconditional distribution of UPLIFT* as predicted by the model.⁹⁸

⁹⁸ The model prediction is computed as follows. Let us denote X_k the average of the explanatory variables of all banks for which $\text{UPLIFT}^*=k$ is observed and let $P(X_k)$ be the probability that a bank has an UPLIFT* equal to k . Trivially $P(X_k)$ corresponds to the empirical probability of the UPLIFT* in Table 4. The model prediction is calculated using the relationship:

$$P(\text{UPLIFT}^* = j) = \sum_{k=0}^m P(X_k) P(\text{UPLIFT}^* = j | X_k)$$

The model enters through the term $P(\text{UPLIFT}^* = j | X_k)$ which is measured as:

$$P(\text{UPLIFT}_i^* = 0 | X_k) = \Phi(\mu_1 - X_k' \beta)$$

$$P(\text{UPLIFT}_i^* = j | X_k) = \Phi(\mu_{j+1} - X_k' \beta) - \Phi(\mu_j - X_k' \beta), j = 1, \dots, m-1$$

$$P(\text{UPLIFT}_i^* = m | X_k) = 1 - \Phi(\mu_m - X_k' \beta)$$

where the β and μ coefficients are given in Table 5.

Table 6: Model 1 goodness of fit

UPLIFT*	0	1	2	3	4	5	6
Frequency	0.12	0.26	0.24	0.30	0.04	0.03	0.01
Model prediction	0.08	0.27	0.29	0.30	0.03	0.03	0.01

As can be seen from Table 6, Model 1 fits the data reasonably well: the largest discrepancy between empirical and predicted probability is equal to 5 percentage points (pp) for the class UPLIFT*=2. For all other classes the discrepancy is less than 4 pp. We now turn to the interpretation of the Probit results.

The sign of the coefficients in Table 5 suggests that:

- Banks with higher stand-alone rating (BCA) have a greater probability to get a small UPLIFT*. As BCA also reflects the riskiness of a bank, the negative coefficient implies that a more risky bank is likely to benefit from a greater UPLIFT*.
- A higher parental support (P) is associated with a smaller UPLIFT*. A bank affiliated to a strong group can receive support within the group and is thus less likely to require public support.
- Banks with higher sovereign rating have a greater probability to receive a large UPLIFT*. A higher sovereign rating implies that the government is in a better position to provide such support.
- Big banks enjoy a larger UPLIFT*: for a given stand-alone and parental rating, the larger the bank the greater the UPLIFT*.

To get a more quantitative picture, we calculate the marginal effect, i.e. the impact on the UPLIFT* distribution of a variation around the average of one of the bank characteristics, the other ones being kept constant at their average value. In the linear regression, a positive coefficient implies a positive impact of the variable. Instead in a Probit regression the explanatory variables describe a probability distribution, so the marginal effect of each variable is positive for some categories of the UPLIFT* and negative for the others. Table 7 below reports such marginal effects in Model 1 – see Appendix J for methodological details.

Table 7: Marginal effects in Model 1

		UPLIFT*					
	Average (st. error)	0	1	2	3	4	5
P(UPLIFT*=j AX)		.023	.276	.409	.277	.010	.005
Stand-alone rating (BCA)	10.56	.021*	.112*	-.001	-.117*	-.009*	-.005*
Parental support (P)	0.72	.030*	.160*	-.002	-.168*	-.010*	-.005*
Sovereign rating (Sov)	16.09	-.020*	-.107*	.001	.111*	.009*	.005*
Size of bank (logTA)	18.65 (1.52)	-.013*	-.067*	.001	.070*	.005*	.003*

Notes: * indicates numbers that are significantly different from 0 at the 10% level. The standard error of logTA is given between parentheses. The average values reported for BCA, P, and Sov are related to the 0-20 coding (see Section 3.1). Notice that the probability that the average bank gets one particular UPLIFT*, i.e. $P(\text{UPLIFT}^*=j|\text{AX})$, should not be compared with the unconditional probability reported in Table 6.

We observe that:

- The stronger the stand-alone rating (BCA) the lower the probability of a large UPLIFT*: a BCA above average by one notch increases the probability that the UPLIFT* does not exceed one notch by 13 pp, from 0.30 to 0.43⁹⁹. Conversely, the probability of an UPLIFT* strictly greater than two notches decreases by 13 pp from 0.29 to 0.16.
- A parental support above average by one notch increases the probability that the UPLIFT* does not exceed one notch by 19 pp, from 0.30 to 0.49. Conversely, the probability of receiving an UPLIFT* strictly greater than two notches decreases by 18 pp from 0.29 to 0.11.
- A sovereign rating above average by one notch increases the probability that UPLIFT* is greater or equal to three notches by 13 pp, from 0.29 to 0.42. Conversely, the probability of receiving an UPLIFT* of zero or one notch decreases by 13 pp from 0.30 to 0.17.
- The average logTA is equal to 18.65 with standard error 1.52. There is considerable heterogeneity among the banks in our dataset since this implies a variation by 350% on the original scale. Banks whose logTA variable is above the average bank size by one standard error have a probability of receiving an UPLIFT* greater than two notches by 12 pp ($1.52 \cdot (.070 + 0.005 + 0.003)$), from 0.29 to 0.41. Conversely, the probability of receiving an UPLIFT* of no more than one notch shrinks from 0.30 to 0.18, which is

⁹⁹ These figures are obtained from Table 7 as follows: the probability of having an UPLIFT* equal to 0 or 1 notch is $0.023 + 0.276 = 0.30$ (third and fourth column). When increasing BCA by one notch, one should add to this quantity the marginal effect of BCA (third and fourth column): $0.30 + 0.021 + 0.112 = 0.43$.

obtained as $0.30 - (1.52 * (.013 + 0.067))$. Hence, banks with larger amount of total assets benefit from a larger UPLIFT*.

These inferences are in broad agreement with the data features shown in Figure 24 to Figure 25. They seem to be robust to several alternatives. For instance, re-weighting the observations using logTA (option “aw” in STATA) does not harm the results. We have checked that the regression is stable over the four semesters by adding time dummies: only the dummy for the first semester of 2011 is significant. As the coefficients of the other variables are almost invariant we do not consider time dummy variables. We also tried country dummies but no improvement was obtained¹⁰⁰.

Some endogeneity may be present in Model 1. First, as acknowledged in Moody’s (2012a) sovereign debt rating methodology, the sovereign debt assessment takes into consideration the risks in the banking sector of the country. Moody’s uses the latest data available, so there is likely simultaneity. Second, the assessment of a bank is based on the bank’s balance sheet and income statement (Moody’s, 2012b). Since the all-in rating¹⁰¹ influences funding costs, the all-in rating impacts on both the balance sheet and the income statement. The impact on bank bond spreads have been analysed for instance in Morgan and Stiroh (2005) and Resti and Sironi (2005). Next, Noss and Sowerbutts (2012) argue that “The implicit guarantee ... distorts banks’ risk-taking incentives as investors no longer fully price the risks they are aware the banks are taking, allowing banks to take more risk. A pernicious spiral can therefore develop, where the existence of an implicit guarantee encourages banks to take more risk” (see also Alessandri and Haldane, 2009).

Such endogenous mechanisms (simultaneity and feedback) imply a bias in the coefficients estimates. To correct for this we substitute the country debt to GDP ratio for the sovereign rating¹⁰² (see also Estrella and Schich, 2012). In order to break any contemporaneous feedback we use a lag for both the debt to GDP ratio and the balance sheet variables. The lag removes Moody’s ratings in the first semester of 2011 from the regression.

Table 8 below shows the results.

¹⁰⁰ Some country dummies were found to be significant at the 10% level, i.e. for AT, IE, NL, SI and UK. They leave unaltered the sign, the order of magnitude, and the significance of the coefficient estimates. More country dummies appear to be significant when the sovereign rating is excluded from the regression, but the coefficients of the other variables remain stable. Given the high correlation between country dummies and sovereign rating, we do not consider it worth adding them.

¹⁰¹ The all-in rating, we remind, is determined together with the UPLIFT*.

¹⁰² The source of data for the debt to GDP ratio is DG ECFIN AMECO database.

Table 8: Model 1B with Debt/GDP ratio substituted for the sovereign rating. Both Debt/GDP and logTA are lagged, 283 observations

Regressors	Coeff.	t-stat.
Stand alone rating (BCA)	-0.158	-5.72
Parental support (P)	-0.051	-1.04
Lagged debt to GDP ratio	-0.022	-7.38
Lagged size of bank (logTA)	0.522	8.73
Log-lik	-392.77	
Log-lik/N	-1.39	

We observe that:

- The lagged Debt/GDP ratio has negative and highly significant coefficient, showing that banks located in countries with high debt to GDP ratio have received a lower UPLIFT*.
- The BCA coefficient is smaller in absolute value but still significant: the impact of BCA is reduced but the direction is preserved.
- The parental support loses significance.
- The coefficient of the log of total assets lagged by one period is larger with high significance.
- Substituting the lagged Debt/GDP ratio for the sovereign rating has an adverse impact on the model fit: the log-likelihood by observation is 20% smaller.

Hence, if an endogenous effect is present, it may have harmed the inference about the impact of the parental support but the model-based inference about the impact of the bank size appears rather robust. As a further robustness check, we use the yield benefit enjoyed by the bank as dependent variable instead of UPLIFT*. Since the yield benefit is a continuous variable and not a categorical one, a simple least-square regression is fitted. Table 9 below shows the results.

Table 9: Model 1C with the yield benefit as dependent variable, 183 observations

Regressors	Coeff.	t-stat.
Stand alone rating (BCA)	-.329	-9.34
Parental support (P)	-.253	-3.37
Lagged debt to GDP ratio	-.022	-5.69
Lagged size of bank (logTA)	.460	6.10
R ²	0.34	

Compared to Table 8 the coefficients estimates appear to be stable enough, except for the parental support whose significance is restored. Hence the empirical evidence about the impact of the sovereign rating and of the bank size is robust to the use of either UPLIFT* or the yield benefit as dependent variable.

We take Model 1B specification in Table 8 as benchmark for examining the role of the various balance sheet variables.

5.4 Empirical results with business model variables

We evaluate the importance of the business model variables first by checking their significance when added one by one to Model 1B. All balance sheet variables are lagged by one period, still for mitigating endogeneity. The short-term funding variable STFTA has been discarded due to numerous missing observations that reduce the effective sample size to one-third compared to the case where STFTA is left out. Out of the fifteen candidates, this first stage identifies RWATA, DEPCTA, NETLOANSBTA, WR, and EquiTA as variables with potential explanatory power. In a second round we add these five variables altogether to Model 1B and remove the ones that appear to be non-significant, namely RWATA and DEPCTA. We are left with the following model:

Table 10: Model 2 with business variables, 264 observations

Regressors	Coeff.	t-stat.
Stand alone rating (BCA)	-.133	-4.29
Parental support (P)	-.201	-3.18
Lagged debt to GDP ratio	-.022	-6.97
Lagged size of bank (logTA)	.366	5.01
Lagged net loans to banks (NETLOANSBTA)	3.729	4.27
Lagged wholesale funding ratio (WR)	.970	2.42
Lagged total equity to total assets (EquiTA)	-6.127	-2.14
Log-lik	-345.54	
Log-lik/N	-1.31	

The cut-offs are estimated at (2.524, 3.750, 4.517, 6.128, 6.448, 6.840, 7.222). We observe that:

- Model 1B and 2 have a similar fit.
- The coefficient of the stand-alone rating, the lagged debt to GDP ratio, and the lagged log of total assets are stable compared to Model 1B in Table 8. There is some instability in the coefficient of the parental support.
- The coefficient of the lagged ratio of net loans to banks to total assets (NETLOANSBTA) is positive, showing that Moody's gives a higher UPLIFT* to banks that are more active in bank lending.
- The wholesale funding ratio (WR) has a positive impact on UPLIFT*: the larger WR, the greater UPLIFT*.
- The coefficient of the lagged equity to total assets ratio (EquiTA) is negative: Moody's gives a lower UPLIFT* to banks that have a high EquiTA ratio. Hence better capitalized banks have a lower UPLIFT*. This leverage variable can be seen as a proxy for the stand-alone rating: for instance we could observe that its significance further increases when the stand-alone rating is not included in the regression.

Table 11 below reports the goodness of fit by UPLIFT* category for Model 2.

Table 11: Goodness of fit of Model 2

UPLIFT*	0	1	2	3	4	5	6
Frequency	0.11	0.30	0.22	0.31	0.02	0.02	0.01
Model prediction	0.08	0.30	0.27	0.31	0.02	0.01	0.00

The empirical frequencies vary slightly because the effective common sample changes according to the missing values in each explanatory variable. As expected, Model 1 and 2 have a similar fit. The maximum error on the empirical frequencies is limited to 5 pp.

Table 12 below displays the marginal effects under Model 2.

Table 12: Marginal effects on UPLIFT* categories for Model 2

	Average (st. error)	0	1	2	3	4	5
P(UPLIFT*=j AX)		.061	.313	.298	.308	.011	.006
Stand alone rating (BCA)	10.10	.016*	.034*	-.002	-.041*	-.003*	-.002*
Parental support (P)	0.76	.024*	.052*	-.003	-.062*	-.004*	-.003*
Lagged debt to GDP ratio	78.19 (30.98)	.003*	.006*	-.000	-.006*	-.001*	-.001*
Lagged size of bank (logTA)	18.57 (1.49)	-.044*	-.095*	.006	.115*	.009*	.006*
Lagged net loans to banks (NETLOANSBTA)	0.10 (0.08)	-.449*	-.963*	.065	1.168*	.091*	.056*
Lagged wholesale funding ratio (WR)	0.48 (0.22)	-.117*	-.251*	.017	.304*	.023*	.014
Lagged total equity to total assets (EquiTA)	0.06 (0.03)	.738	1.583*	-.108	-1.919*	-.149	-.092

Notes: * indicates numbers that are significantly different from 0 at the 10% level. The standard error of continuous variables is given between parentheses.

Comments:

- The marginal effects of stand-alone rating (BCA) and parental support (P) are broadly stable compared to Model 1B. We do not comment further on these variables.
- Also the bank size has a similar impact over Model 1B and 2: both models foresee a positive and significant effect on the probability to get an UPLIFT* greater than 2 when total assets is above average.

- Banks located in a country where the debt to GDP ratio is above average by one standard error have a probability of receiving an UPLIFT* greater than two notches that shrinks by 25pp ($30.98*(-.006-.001-.001)$), while the probability of receiving an UPLIFT* of no more than one notch increases by 28pp ($30.98*(.006+.003)$).
- Banks whose net loans to banks to total assets ratio is above average by one standard error have a probability of receiving an UPLIFT* greater than two notches that increases by 11pp ($0.08*(1.168+.091+.056)$), while the probability of receiving an UPLIFT* of no more than one notch decreases by 11pp ($0.08*(-.449-.963)$).
- Banks whose wholesale funding ratio is above average by one standard error have a probability of receiving an UPLIFT* greater than two notches that increases by 8pp ($0.22*(.304+.023+.014)$), while the probability of receiving an UPLIFT* of no more than one notch decreases by about 8pp ($0.22*(-.117-.251)$).
- Banks whose total equity over total assets ratio is above average by one standard error have a probability of receiving an UPLIFT* greater than two notches that decreases by 6pp ($0.03*(-1.919 -.149 -.092)$), while the probability of receiving an UPLIFT* of no more than one notch increases by about 7pp ($0.03*(.738+1.583)$).

This inference is in broad agreement with the Box-plots in Figure 25 and Figure 26.

We have also substituted the sovereign rating for the debt to GDP ratio in Model 2. All coefficients remain significant except the wholesale funding ratio whose impact becomes insignificant. As a further robustness check, we have re-scaled the UPLIFT* variable by stand-alone plus parental rating, i.e. $UPLIFT*/(21-BCA-P)$, as in Bijlsma and Mocking (2013). This re-scaled variable takes into account that the absolute uplift is constrained by the adjusted BCA. Running a least-square regression, we could observe that all variables in Model 2 remain significant as in Table 10.

Furthermore, to check the robustness of Model 2, we substitute the yield benefit for the UPLIFT*. Table 13 below shows the results. All coefficients remain significant except the total equity to total assets ratio which loses significance.

Table 13: Model 2B with the yield benefit as dependent variable. 166 observations

Regressors	Coeff.	t-stat.
Stand alone rating (BCA)	-0.297	-7.81
Parental support (P)	-0.350	-4.48
Lagged debt to GDP ratio	-0.020	-5.30
Lagged size of bank (logTA)	0.279	2.94
Lagged net loans to banks (NETLOANSBTA)	3.014	2.83
Lagged wholesale funding ratio (WR)	0.919	1.95
Lagged total equity to total assets (EquiTA)	-4.914	-1.34
R ²	0.393	

6. Conclusions

This report investigates the size and determinants of the implicit state guarantee, as measured by UPLIFT*, enjoyed by a sample of EU banks. It also estimates in monetary terms the implicit subsidy due to this guarantee.

The size of the implicit guarantee is measured using the *rating-based approach* based on Moody's credit ratings. Long-term credit ratings take into account the bank's stand-alone financial strength rating, a rating upgrade due to possible support from a parent or a cooperative group, and a rating upgrade due to potential government support. This third component (which in the report is denoted by UPLIFT*) is used to measure the implicit government guarantee. The implicit guarantee is translated into a funding cost advantage by comparing the funding cost inferred from the long-term credit rating of a bank with the funding cost inferred from its stand-alone credit rating. Multiplying the funding cost advantage with a share of the outstanding debt results in a monetary estimate which can be viewed as an implicit subsidy given to banks.

Main conclusions on the size of the implicit government guarantee (measured through the UPLIFT*):

- Statistics on our Moody's dataset on EU banks ratings, covering 112 banks from 23 EU countries in the period 2011-2013, are in line with the few studies available for the EU and confirm that many EU banks enjoy a government implicit guarantee that increases their ratings.
- In the period 2011-2013 the largest part of the distribution of the UPLIFT* lies between 1 and 3 notches on average.
- The top 25% banks in size (roughly 25 banks, where most of the EU G-SIBs are represented) enjoy an implicit government guarantee larger than the remaining banks in the sample. The relative difference between the average UPLIFT* of largest banks and the remaining ones is between 7% and 26%, depending on the point in time.
- The average upgrade due to implicit guarantee is relatively stable over the period under study, while a decrease in the average long-term credit rating can be observed.

Main conclusions on the implicit subsidy:

- The reduction in banks' funding costs due to the implicit government guarantee obtained via the rating-yield map is largely in line with previous literature studies.
- The total implicit subsidy for the considered sample is estimated in the interval **EUR 72 to 95 billion euro** in 2011 and **EUR 59 to 82 billion euro** in 2012.
- In relative terms, the implicit subsidy for ranges between 0.5% and 0.8% of EU-27 GDP.

- The estimated implicit subsidy is 0.4-0.7% GDP for DE, 0.9-1.5% for FR and 0.4% for UK as of end 2012.
- The estimated implicit subsidy is between 30% and 50% of the banks aggregated annual pre-impairment operating profit.

Main conclusions on implicit state guarantee (measured through the UPLIFT*) drivers:

In our sample of EU banks, the UPLIFT* appears to be driven by:

- The bank individual strength: as expected, a higher individual strength rating increases the probability of observing lower UPLIFT*;
- The parental support: as expected, banks with stronger parents receive a lower UPLIFT*.
- The credit rating of the country where a bank is headquartered: being headquartered in a country with a strong sovereign credit rating increases the probability of observing a higher UPLIFT*. This evidence also appears if the debt to GDP ratio is used as a proxy for the sovereign credit worthiness.
- The size of the bank: larger banks are more likely to enjoy a greater UPLIFT*.

Concerning the business model we find the following evidence:

- More inter-connected banks that hold a larger proportion of net loans to banks in their total assets benefit from a higher UPLIFT*.
- Banks that rely relatively more on the wholesale market for funding compared to other banks (i.e. a high wholesale funding ratio) also benefit from a higher UPLIFT*.
- Better capitalized banks are more likely to receive a lower implicit guarantee.

References

Alessandri P. and Haldane A., 2009, *Banking on the state*, twelfth annual International Banking Conference on ‘The international financial crisis: have the rules of finance changed?’, Federal Reserve Bank of Chicago.

Ayadi R., Arbak E., and de Groen W.P., 2012, *Regulation of European Banks and Business Models: Towards a New Paradigm?*, Centre for European Policy Studies, Brussels.

Bijlsma M.J. and Mocking R.J.M., 2013, *The private value of too-big-to fail guarantees*, discussion paper 240, CPB Netherlands Bureau for Economic Policy Analysis, available at www.cpb.nl/sites/.../dp240-private-value-too-big-fail-guarantees_0.pdf.

Blundell-Wignall A. and Roulet C., 2013, *Business models of banks, leverage and the distance-to-default*, OECD Journal: Financial Market Trends, 103, 1-29.

Blundell-Wignall A. and Atkinson, P., 2011, *Global SIFIs, Derivatives and Financial Stability* OECD Journal: Financial Market Trends, 1, 1-34.

Estrella A. and Schich S., 2012, *Sovereign and Banking Sector Debt: Interconnections through guarantees*, OECD Journal: Financial Market Trends, Volume 2011, Issue 2.

Haldane A. G., 2010, *The \$100 Billion Question*, BIS Review 40/2010.

Haldane A. G., 2011, *Control Rights (and Wrongs)*, speech at the Wincott Annual Memorial Lecture.

Haldane A. G., 2012, *On being the right size*, speech given on 25th October.

International Monetary Fund, *Global Financial Stability Report*, October 2013.

Moody’s Investor Service, 2012a, *Proposed Refinements to the Sovereign Bond Rating Methodology*.

Moody’s Investor Service, 2012b, *Moody’s Consolidated Global Bank Rating*.

Morgan D. and Stiroh K., 2005, *Too Big to Fail after All These Years*, Federal Reserve Bank of New York Staff Reports.

Noss J. and Sowerbutts R., 2012, *The implicit subsidy of banks*, Financial Stability Paper No. 15, Bank of England.

Resti A. and Sironi A., 2005, *The Basel Committee Approach To Risk-Weights And External Ratings: What Do We Learn From Bond Spreads?*, Economic Working Paper nr. 548, Bank of Italy.

Schich S. and Lindh, 2012, *Implicit Guarantees for Bank Debt: Where Do We Stand?*, OECD Journal: Financial Market Trends, Volume 2012, Issue 1, downloadable at

www.oecd.org/finance/financial-markets/Implicit-Guarantees-for-bank-debt.pdf

Schich S. and Kim B.H., 2012, *Developments in the Value of Implicit Guarantees for Bank Debt: The Role of Resolution Regimes and Practices*, OECD Journal: Financial Market Trends, Volume 2012, Issue 2, www.oecd.org/finance/Value_Implicit_Guarantees_Bank_Debt.pdf.

Ueda K., and Di Mauro B.W., 2012, *Quantifying Structural Subsidy Values for Systemically Important Financial Institutions*, IMF Working Paper, WP/12/128.

Appendix A: List of Banks

Country	Company Name, Short
AT	UniCredit Bank Austria AG
	Erste Group Bank AG
	Raiffeisen Bank International AG
	Österreichische Volksbanken-AG
	Bank für Arbeit und Wirtschaft und Österreichische Postsparkasse AG
BE	Belfius Banque SA
	BNP Paribas Fortis SA
	KBC Bank NV
	ING Belgium SA/NV
BG	DSK Bank EAD
	Raiffeisenbank (Bulgaria) EAD
CY	Cyprus Popular Bank Public Co. Ltd.
	Bank of Cyprus Public Company Limited
	Hellenic Bank Public Company Limited
CZ	Česká spořitelna, a.s.
	Ceskoslovenska obchodni banka, a.s.
	Komerční banka, a.s.
DK	Danske Bank A/S
	Nordea Bank Danmark A/S
FI	Nordea Bank Finland Plc
	Pohjola Bank Plc
	Danske Bank Oyj
FR	BNP Paribas SA
	Crédit Agricole SA

Country	Company Name, Short
	Crédit Agricole Corporate and Investment Bank
	Natixis
	Crédit Foncier de France SA
	Société Générale SA
	Banque Fédérative du Crédit Mutuel SA
	Dexia Crédit Local SA
DE	Deutsche Bank AG
	Commerzbank AG
	Hypothesenbank Frankfurt AG
	UniCredit Bank AG
	LBBW Landesbank Baden-Württemberg
	Deutsche Zentral-Genossenschaftsbank AG
	Bayerische Landesbank
	NORD/LB Norddeutsche Landesbank Girozentrale
	Deutsche Postbank AG
	HSH Nordbank AG
	Landesbank Hessen-Thüringen Girozentrale
	DekaBank Deutsche Girozentrale
	Westdeutsche Genossenschafts-Zentralbank AG
GR	National Bank of Greece SA
	Eurobank Ergasias SA
	Alpha Bank AE

Country	Company Name, Short
	Piraeus Bank SA
HU	K&H Bank Zrt.
	MKB Bank Zrt.
	Erste Bank Hungary Zrt.
IE	Depfa ACS Bank
	Bank of Ireland
	Allied Irish Banks, Plc
	Ulster Bank Limited
IT	UniCredit SpA
	Intesa Sanpaolo SpA
	Banca IMI SpA
	Banca Monte dei Paschi di Siena SpA
	Unione di Banche Italiane SCpA
	Banco Popolare Società Cooperativa
LU	Banque Internationale à Luxembourg SA
	BGL BNP Paribas SA
	Banque et Caisse d'Epargne de l'Etat, Luxembourg
	UniCredit Luxembourg SA
NL	ING Bank NV
	Royal Bank of Scotland N
	ABN AMRO Bank NV
	Rabobank Nederland
PL	Powszechna Kasa Oszczędności Bank Polski SA
	BRE Bank SA
	ING Bank Śląski SA

Country	Company Name, Short
	Bank Zachodni WBK SA
	Bank Millennium SA
	Bank Handlowy w Warszawie SA
	Bank BPH SA
PT	Caixa Geral de Depósitos SA
	Banco Comercial Português SA
	Banco Espírito Santo SA
	Banco Santander Totta SA
	Banco BPI SA
RO	Banca Comerciala Romana SA
	Raiffeisen Bank SA
SK	Všeobecná úverová banka, a.s.
	Tatra banka, a.s.
	Ceskoslovenska Obchodni
SI	Nova Ljubljanska Banka d.d.
	Nova Kreditna banka Maribor d.d.
	Abanka Vipava d.d.
ES	Banco Santander SA
	Banco Español de Crédito SA
	Banco Bilbao Vizcaya Argentaria, SA
	Bankia, SA
	CaixaBank, SA
	Banco Popular Español SA
	Banco de Sabadell, SA
Bankinter SA	

Country	Company Name, Short
	Ibercaja Banco SAU
SE	Nordea Bank AB
	Skandinaviska Enskilda Banken AB
	Svenska Handelsbanken AB
	Swedbank AB
UK	Royal Bank of Scotland Plc
	HSBC Bank Plc
	Bank of Scotland Plc
	Lloyds TSB Bank Plc
	National Westminster Bank Plc
	Santander UK Plc
	Nationwide Building Society
	Barclays Bank PLC
	Standard Chartered Bank

Appendix B: Statistics on Moody's rating data

Table B.1 to Table B.4 summarizes statistics on LT, BCA, BCAadj, Sov (country sovereign), and BCAadj-BCA (p) for each time period (the categories from C to AAA are translated into an index over the range 0-20).

Table B.1: Summary statistics for June 2011

LTRating	Freq.	Percent	Cum.		
5	4	3.92	3.92		
9	2	1.96	5.88		
10	1	0.98	6.86		
11	11	10.78	17.65		
12	7	6.86	24.51		
13	4	3.92	28.43		
14	4	3.92	32.35		
15	12	11.76	44.12		
16	18	17.65	61.76		
17	24	23.53	85.29		
18	13	12.75	98.04		
19	1	0.98	99.02		
20	1	0.98	100.00		
Total	102	100.00			
BCA	Freq.	Percent	Cum.		
4	4	4.04	4.04		
6	1	1.01	5.05		
7	1	1.01	6.06		
8	8	8.08	14.14		
9	10	10.10	24.24		
10	7	7.07	31.31		
11	11	11.11	42.42		
12	17	17.17	59.60		
13	9	9.09	68.69		
14	15	15.15	83.84		
15	12	12.12	95.96		
16	4	4.04	100.00		
Total	99	100.00			
BCAadj	Freq.	Percent	Cum.		
4	4	4.44	4.44		
6	1	1.11	5.56		
8	5	5.56	11.11		
9	5	5.56	16.67		
10	4	4.44	21.11		
11	8	8.89	30.00		
12	15	16.67	46.67		
13	11	12.22	58.89		
14	12	13.33	72.22		
15	15	16.67	88.89		
16	9	10.00	98.89		
17	1	1.11	100.00		
Total	90	100.00			
CountrySov	Freq.	Percent	Cum.		
4	4	3.57	3.57		
11	11	9.82	13.39		
13	5	4.46	17.86		
15	10	8.93	26.79		
16	6	5.36	32.14		
18	18	16.07	48.21		
19	4	3.57	51.79		
20	54	48.21	100.00		
Total	112	100.00			
Variable	Obs	Mean	Std. Dev.	Min	Max
ltrating	102	14.80392	3.184241	5	20
bca	99	11.60606	2.856493	4	16
bcaadj	90	12.35556	2.98427	4	17
countrysov	112	17.21429	3.92825	4	20

Table B.2: Summary statistics for December 2011

LTRating	Freq.	Percent	Cum.		
3	4	3.70	3.70		
6	2	1.85	5.56		
8	2	1.85	7.41		
9	8	7.41	14.81		
10	3	2.78	17.59		
11	5	4.63	22.22		
12	6	5.56	27.78		
13	10	9.26	37.04		
14	4	3.70	40.74		
15	21	19.44	60.19		
16	18	16.67	76.85		
17	18	16.67	93.52		
18	6	5.56	99.07		
20	1	0.93	100.00		
Total	108	100.00			

BCA	Freq.	Percent	Cum.		
2	4	3.70	3.70		
5	2	1.85	5.56		
6	3	2.78	8.33		
7	2	1.85	10.19		
8	10	9.26	19.44		
9	13	12.04	31.48		
10	5	4.63	36.11		
11	11	10.19	46.30		
12	13	12.04	58.33		
13	15	13.89	72.22		
14	16	14.81	87.04		
15	10	9.26	96.30		
16	4	3.70	100.00		
Total	108	100.00			

BCAadj	Freq.	Percent	Cum.		
2	4	3.85	3.85		
5	1	0.96	4.81		
6	3	2.88	7.69		
7	1	0.96	8.65		
8	7	6.73	15.38		
9	9	8.65	24.04		
10	4	3.85	27.88		
11	6	5.77	33.65		
12	14	13.46	47.12		
13	19	18.27	65.38		
14	14	13.46	78.85		
15	12	11.54	90.38		
16	10	9.62	100.00		
Total	104	100.00			

CountrySov	Freq.	Percent	Cum.		
1	4	3.57	3.57		
9	5	4.46	8.04		
10	7	6.25	14.29		
11	5	4.46	18.75		
12	2	1.79	20.54		
15	13	11.61	32.14		
16	18	16.07	48.21		
17	4	3.57	51.79		
20	54	48.21	100.00		
Total	112	100.00			

Variable	Obs	Mean	Std. Dev.	Min	Max
ltrating	108	13.81481	3.609821	3	20
bca	108	11.17593	3.240597	2	16
bcaadj	104	11.84615	3.323261	2	16
countrysov	112	16.33036	4.671918	1	20

Table B.3: Summary statistics June 2012

LTRating	Freq.	Percent	Cum.		
3	4	3.60	3.60		
5	1	0.90	4.50		
6	2	1.80	6.31		
7	1	0.90	7.21		
8	6	5.41	12.61		
9	7	6.31	18.92		
10	6	5.41	24.32		
11	9	8.11	32.43		
12	10	9.01	41.44		
13	6	5.41	46.85		
14	15	13.51	60.36		
15	26	23.42	83.78		
16	8	7.21	90.99		
17	8	7.21	98.20		
18	1	0.90	99.10		
19	1	0.90	100.00		
Total	111	100.00			
BCA	Freq.	Percent	Cum.		
2	4	3.60	3.60		
4	1	0.90	4.50		
5	3	2.70	7.21		
6	8	7.21	14.41		
7	6	5.41	19.82		
8	10	9.01	28.83		
9	13	11.71	40.54		
10	9	8.11	48.65		
11	13	11.71	60.36		
12	24	21.62	81.98		
13	8	7.21	89.19		
14	9	8.11	97.30		
15	1	0.90	98.20		
16	2	1.80	100.00		
Total	111	100.00			
BCAadj	Freq.	Percent	Cum.		
2	4	3.64	3.64		
5	2	1.82	5.45		
6	8	7.27	12.73		
7	4	3.64	16.36		
8	4	3.64	20.00		
9	10	9.09	29.09		
10	8	7.27	36.36		
11	13	11.82	48.18		
12	27	24.55	72.73		
13	10	9.09	81.82		
14	12	10.91	92.73		
15	5	4.55	97.27		
16	3	2.73	100.00		
Total	110	100.00			
CountrySov	Freq.	Percent	Cum.		
0	4	3.57	3.57		
8	8	7.14	10.71		
10	7	6.25	16.96		
11	11	9.82	26.79		
12	2	1.79	28.57		
14	6	5.36	33.93		
15	13	11.61	45.54		
16	3	2.68	48.21		
17	4	3.57	51.79		
19	9	8.04	59.82		
20	45	40.18	100.00		
Total	112	100.00			
Variable	Obs	Mean	Std. Dev.	Min	Max
lrating	111	12.65766	3.473263	3	19
bca	111	10.01802	3.051027	2	16
bcaadj	110	10.76364	3.129989	2	16
countrysov	112	15.58036	5.126575	0	20

Table B.4. Summary statistics December 2012

LTRating	Freq.	Percent	Cum.
3	4	3.57	3.57
4	3	2.68	6.25
5	2	1.79	8.04
6	2	1.79	9.82
7	1	0.89	10.71
8	4	3.57	14.29
9	7	6.25	20.54
10	7	6.25	26.79
11	8	7.14	33.93
12	13	11.61	45.54
13	6	5.36	50.89
14	12	10.71	61.61
15	27	24.11	85.71
16	7	6.25	91.96
17	7	6.25	98.21
18	1	0.89	99.11
19	1	0.89	100.00
Total	112	100.00	

BCA	Freq.	Percent	Cum.
2	6	5.36	5.36
3	4	3.57	8.93
4	6	5.36	14.29
5	2	1.79	16.07
6	3	2.68	18.75
7	4	3.57	22.32
8	11	9.82	32.14
9	11	9.82	41.96
10	8	7.14	49.11
11	13	11.61	60.71
12	24	21.43	82.14
13	11	9.82	91.96
14	7	6.25	98.21
16	2	1.79	100.00
Total	112	100.00	

BCAadj	Freq.	Percent	Cum.
2	6	5.36	5.36
3	4	3.57	8.93
4	5	4.46	13.39
6	3	2.68	16.07
7	3	2.68	18.75
8	4	3.57	22.32
9	7	6.25	28.57
10	10	8.93	37.50
11	12	10.71	48.21
12	28	25.00	73.21
13	13	11.61	84.82
14	11	9.82	94.64
15	3	2.68	97.32
16	3	2.68	100.00
Total	112	100.00	

CountrySov	Freq.	Percent	Cum.
0	4	3.57	3.57
5	3	2.68	6.25
8	5	4.46	10.71
10	7	6.25	16.96
11	11	9.82	26.79
12	11	9.82	36.61
15	10	8.93	45.54
16	3	2.68	48.21
17	4	3.57	51.79
19	19	16.96	68.75
20	35	31.25	100.00
Total	112	100.00	

Variable	Obs	Mean	Std. Dev.	Min	Max
ltrating	112	12.33036	3.713594	3	19
bca	112	9.598214	3.498931	2	16
bcaadj	112	10.375	3.604614	2	16
countrysov	112	15.22321	5.273954	0	20

Appendix C: Comparison with the existing literature

This Appendix attempts to compare summary statistics for the UPLIFT and UPLIFT* presented in the literature with the results obtained in Section 3. We are also comparing our implicit subsidy estimate with those available in the literature. We mainly focus on Schich and Lindh (2012), Haldane (2010, 2011, and 2012) and Bijlsma and Mocking (2013). Only a qualitative comparison can be performed since in the available studies the samples as well as the ratings employed differ.

*C.1 Comparison of the UPLIFT and UPLIFT**

C.1.1 Comparison with: Schich and Lindh (2012)

Schich and Lindh (2012) employ a dataset of 118 large European banks for calculating the UPLIFT using Moody's data. Their calculations are done on a yearly basis (from 2007 to 2011). The last trimester of 2012 is also taken into consideration.

Comparing the results from Schich and Lindh (2012) and Figure 2 one can conclude that the UPLIFT is essentially the same (in this study we have on average 0.5 notches higher UPLIFT for each time period). In more detail:

	Average UPLIFT Schich and Lindh (2012)	Average UPLIFT (this study)
2007	2.21	2.69
2008	2.40	2.90
2009	3.14	3.73
2010	3.12	3.59
2011	2.18	2.63
2012	2.20 (Mar-2012)	2.73 (Dec-2012)

In the same study the authors calculate the average UPLIFT* for each country employed in their sample for March-2012. For comparison purposes Figure C.1 presents the average UPLIFT* for each county for June 2012.

Figure C.1: Average UPLIFT* as of June 2012 from this study

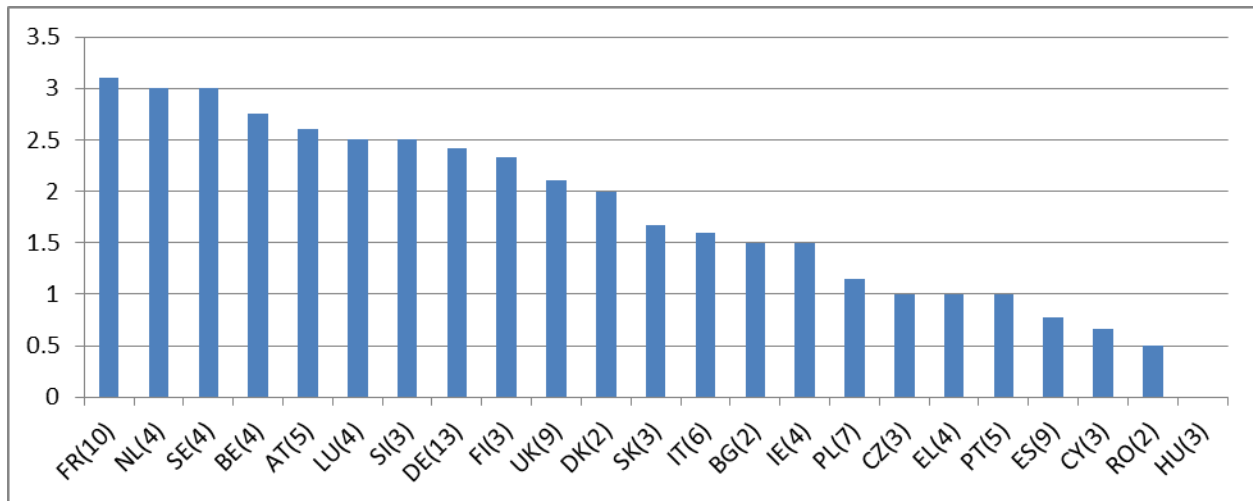

Source: Moody's and own calculations

Direct comparisons for the calculated UPLIFT* between Schich and Lindh (2012) and this study cannot be made as:

- 1) For most of the countries a different number of banks is considered.
- 2) The banks included in Schich and Lindh (2012) cannot be identified.
- 3) The authors of Schich and Lindh (2012) calculate the UPLIFT* as of March-2012, while in Figure C.3 the UPLIFT* is calculated as of June-2012. For many banks in the sample, ratings changed between March-2012 and June-2012 (see Table C.1).

Table C.1: Comparison of UPLIFT* samples

Country ¹⁰³	UPLIFT* (this study) as of June 2012	UPLIFT* from Schich and Lindh (2012) as of March 2012	#Banks in this study	#Banks in Schich and Lindh (2012)	#of banks for which ratings changed after 31/03/2012
BE	2.75	≈4	4	2	4
DK	2.00	≈0.5	2	5	2
DE	2.42	≈2.8	13	17	11
IE	1.50	≈0.3	4	3	1
EL	1.00	≈1	4	5	0
ES	0.78	≈1	9	10	9
FR	3.10	≈2.8	10	7	9
IT	1.60	≈1	6	13	4
LU	2.50	≈4.5	4	2	3
NL	3.00	≈1.4	4	8	3
AT	2.60	≈3.7	5	6	4
PT	1.00	≈0.4	5	6	2
FI	2.33	≈1.9	2	2	3
SE	3.00	≈1.9	4	6	2
UK	2.11	≈1.5	9	14	6
Average	2.11	≈1.91			

From the results presented in Table C.1 it can be concluded that for the countries for which a large number of banks is included in both samples (e.g. Germany, France and Spain) the average UPLIFT* is similar. Moreover, for Greece we observe that the average UPLIFT* is the same,

¹⁰³ In parentheses the respective number of banks

while for Ireland, if we exclude one bank (which had an UPLIFT* equal to 5) we obtain the same UPLIFT*. For the countries for which there is large difference in the number of banks (e.g. Denmark, Netherlands and Italy) no conclusions can be drawn.

C.1.2 Comparison with Haldane (2012)

There are two main issues when comparing our study with Haldane (2012):

- 1) Haldane (2012) reports the UPLIFT for 29 institutions deemed by the Financial Stability Board (FSB) to be the world's most systemically-important. Thus non-EU banks are in the sample.
- 2) The ratings used in the present study and in Haldane (2012) are different. Haldane (2012) must rely on the Bank Financial Strength rating (BFSR), as UPLIFTs prior to 2011 are reported (the first announcement of the BCA, at least for the European banks, was in 2011). In contrast, this study relies on the BCA Moody's rating and the rating scales of the two differ.

As discussed above, no direct comparisons can be made, as our sample includes only 13 EU G-SIBs banks. However, in order to have an intuition of the direction in which their average UPLIFT moves over time, we summarize in Table C.2 the evolution of the average UPLIFT.

Table C.2: Statistics of the sample used in the present study

	UPLIFT
2011st	2.62
2011nd	2.08
2012st	2.38
2012nd	2.23

Comparing Table C.2 and the results presented in Haldane (2012) one can conclude that in both studies between 2011 and 2012 the UPLIFT for the G-SIBs is between 2 and 3 notches.

C.1.3 Comparison with Bijlsma and Mocking (2013)

Bijlsma and Mocking (2013) is based on a sample of 151 European banks which partly overlaps with the banks in our sample. As in Haldane (2012), Bijlsma and Mocking (2013) use the BFSR

to calculate the UPLIFT. The authors conclude that banks enjoy an average UPLIFT of 2.9 for 2011 and 2.5 for 2012 respectively.

In Table C.3 summary statistics for the average UPLIFT calculated for the sample used in the present study are presented.

Table C.3: UPLIFT statistics (present study)

	<i>Dec-2011</i>		<i>Dec-2012</i>
Mean	2.63	Mean	2.73
Minimum	0	Minimum	0
Maximum	8	Maximum	8
Count	108	Count	112

Although averages for the UPLIFT points in time are similar, one must be cautious on making exact comparisons as the rating scales for BFSR and BCA differ.

C.2 Comparison of implicit subsidy estimates

One must be cautious when making a comparison of our results with the results presented in other studies on the implicit subsidy. Due to differences in definition of rating sensitive liabilities, the estimation of the yield spreads and the sample of banks the estimates will most likely not perfectly match. Schich and Lindh (2012), for example, report banks' implicit subsidies for France, UK and Germany to be 1%, 0.4% and 1.4% of domestic GDP, respectively, for March 2012 (when using their upper bound estimates). Our estimates of the implicit subsidy for banks in France and UK are around 0.9-1.5% and 0.4% in 2012H2, which is in line with their results. For Germany we report an implicit subsidy of 0.5-0.7% (of domestic GDP) in 2012H2, which is half the Schich and Lindh (2012) estimate. Bijlsma and Mocking (2013) estimate the implicit subsidy to be in the range of 0.5-1.5%, 0.5-1.2% and 0.5-1.2% of domestic GDP for France, UK and Germany, respectively, in 2011. We estimate the implicit subsidy to be around 1-1.5%, 0.8% and 0.5-0.7% for the banks in these countries in 2011H2.

In Haldane (2010), the estimation of the average total annual subsidy of the five largest UK banks equals GBP 55 billion for the period 2007-2009. The proxy used in this study for rating-sensitive liabilities excludes retail deposits but includes wholesale borrowing. Haldane (2011) reports an average total annual subsidy of USD 74 billion for the period 2007-2010 for the four

largest UK banks. In 2010, the total annual subsidy is estimated to USD 58 billion. The proxy for rating-sensitive liabilities is not explicitly defined.

Noss and Sowerbutts (2012) reports implicit subsidy estimates (with the ratings based approach) to around 5, 25-30, around 130, and around 40 GBP billion in 2007, 2008, 2009, and 2010, respectively.

In our study, we estimate the implicit subsidy for the four largest UK banks (RBS, HSBC, Lloyds and Barclays) to be around EUR 12 and EUR 7 billion in 2011 and 2012, respectively, when using the long-term funding proxy for rating-sensitive liabilities. Adding Santander UK to the others, we get EUR 13.6 and EUR 7.7 billion in 2011 and 2012, respectively. For the implicit subsidy estimates based on the total debt proxy, we do not have any data for Barclays. However for the other four banks, we estimate the implicit subsidy to be EUR 13.4 and EUR 8.4 billion in 2011 and 2012, respectively.

Appendix D: UPLIFT* for selected large EU groups

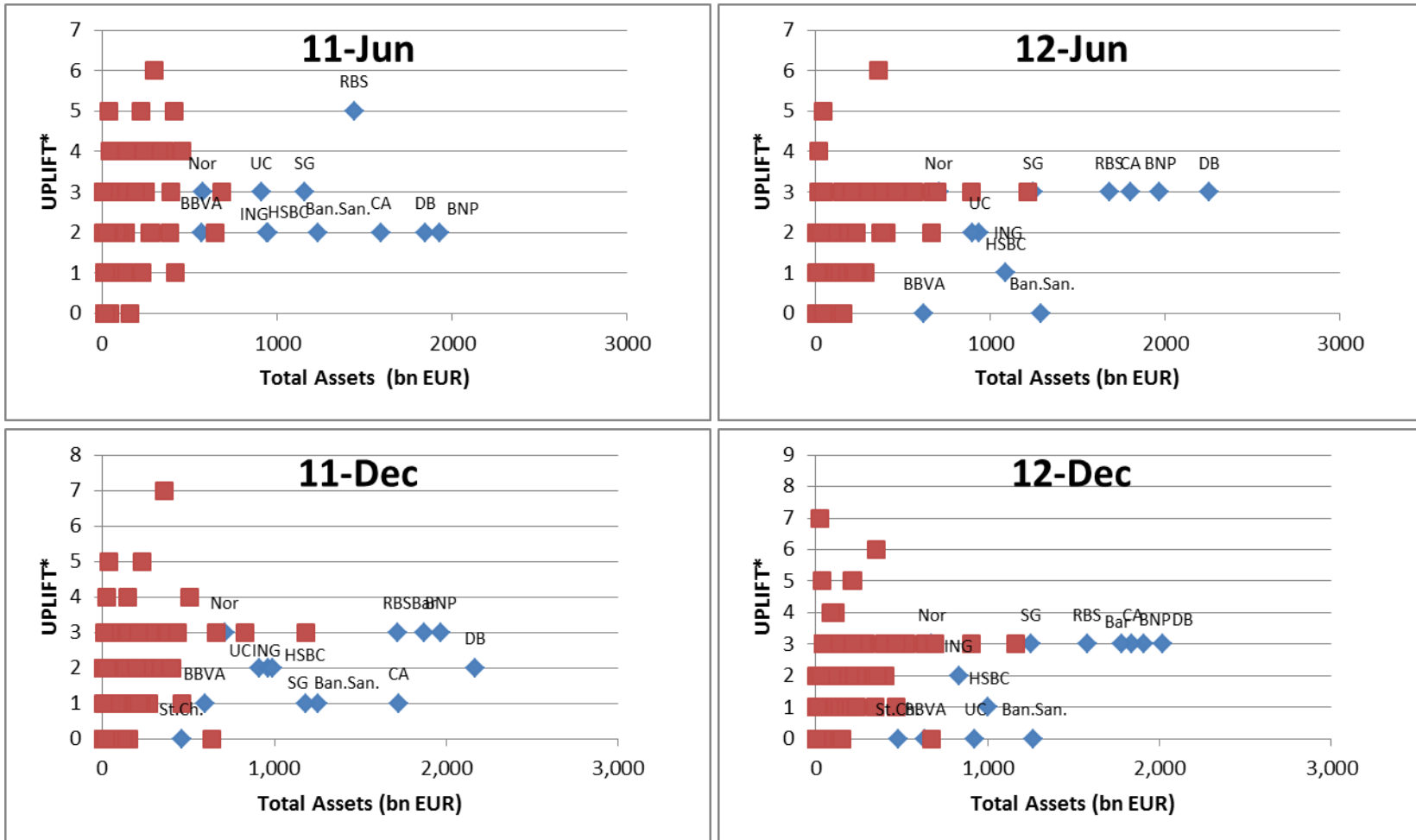

Source: SNL, Moody's and own calculations

Note: BNP Paribas (BNP), Deutsche Bank AG (DB), Credit Agricole SA (CA), Royal Bank of Scotland (RBS), Banco Santander S.A. (Ban.San), Societe Generale SA (SG), Lloyds TSB Bank (LI), HSBC Bank PLC (HSBC), ING Bank NV (ING), UniCredit SpA (UC), Nordea Bank AB (Nord), Bank of Scotland PLC (BS), Barclays (Bar), Standard Chartered (St.Ch.)

Appendix E: Descriptive statistics of the sample used for building the rating-yield map

The rating-yield curve is built by taking weekly observations of market yields for a sample of European banks from 18 countries. We have built one rating-yield curve for 2011H2 and one for 2012H2.

The data on bond yield spreads and long-term credit ratings are taken from DG ECFIN's Bank Watch.¹⁰⁴ The yield spreads are with respect to German 5 year bonds (Bobl).¹⁰⁵ The maturity of the bank bonds may vary between 4.5 and 5.5 years.¹⁰⁶

Descriptive statistics for the two semesters (2011H2 and 2012H2) are presented in Table E.1. For both semesters, the number of weeks is 22. The 2011H2 sample contains 74 banks, while the 2012H2 sample covers 80 banks. The total number of observations is 1590 and 1760 in 2011H2 and 2012H2, respectively.

The average yield spreads has fallen for each rating bucket in 2012H2 compared to 2011H2. In Table E.1, one can also observe that the majority of observations (covering 85% of the observations) in 2011H2 was in rating classes Aa2 to Baa2, while in 2012H2 it is Aa3 to Ba1 that have the majority of observations, illustrating that banks have been downgraded.

¹⁰⁴ The source of the Bank Watch data is Bloomberg.

¹⁰⁵ We have used yield spreads to isolate the credit risk component of each bank bond and to facilitate a comparison between bonds.

¹⁰⁶ A mixture of bonds is used to estimate the yields, mainly senior unsecured and covered bonds.

Table E.1. Descriptive statistics of sample for the rating - yield spread map

Rating	2011H2			2012H2		
	Average yield spread	Average number of banks / week	Total number of observations	Average yield spread	Average number of banks / week	Total number of observations
Aaa	66.65	1.0	22	7.9	1.0	22
Aa1	124.83	1.4	30	56.5	1.3	29
Aa2	184.20	11.2	246	#N/A	0.0	0
Aa3	238.33	14.0	309	79.4	5.2	115
A1	225.57	12.1	267	129.4	4.0	88
A2	370.34	13.0	287	145.8	14.5	318
A3	258.94	7.1	157	151.6	13.7	301
Baa1	343.27	0.9	20	231.8	4.0	88
Baa2	528.24	3.3	72	384.2	11.5	252
Baa3	526.34	1.9	42	389.6	9.9	218
Ba1	1098.61	2.9	64	801.3	5.7	126
Ba2	1061.65	1.5	32	500.9	2.4	53
Ba3	1222.25	0.5	10	544.4	3.9	85
B1	#N/A	0.0	0	698.1	1.1	25
B2	#N/A	0.0	0	#N/A	0.0	0
B3	1438.38	0.5	12	#N/A	0.0	0
Caa1	#N/A	0.0	0	#N/A	0.0	0
Caa2	2114.92	0.9	20	1506.7	1.8	40
Caa3	#N/A	0.0	0	#N/A	0.0	0
Ca	#N/A	0.0	0	#N/A	0.0	0
C	#N/A	0.0	0	#N/A	0.0	0
Total		72.3	1590		80.0	1760

Appendix F: Description of the proxies for the rating-sensitive liabilities

The estimation of implicit subsidy is based on two alternative approximations of rating sensitive liabilities: Total Debt from SNL and Total Long-term Funding from Bankscope.

Estimate 1: Total Debt

Total Debt is part of the total financial liabilities, as reported in SNL. ‘Total Financial Liabilities’ consist of:

- Total Deposits: Total Deposits from Banks + Total Customer Deposits;
- Total Debt: Total Subordinated debt + Senior Debt;
- Derivative Liabilities¹⁰⁷; and
- Other Financial Liabilities (incl. Securities Sold, not yet purchased).

In our sample, SNL reports Total Debt for 90 banks for both 2011 and 2012.

Estimate 2: Total Long-term Funding

Total long-term funding is part of the total funding, as reported in Bankscope. ‘Total Funding’ consists of:

- Total Deposits, Money Market and short-term funding = Total Customer Deposits + Deposits from Bank + Other Deposits and Short-term Borrowings
- Total Long-term funding = Senior Debts Maturing after one Year¹⁰⁸ + Subordinated Borrowing¹⁰⁹ + Other Funding;
- Derivatives¹¹⁰; and
- Trading Liabilities¹¹¹.

In our sample, Bankscope reports Total Long-term Funding for 96 banks for 2011 and for 97 banks for 2012.

Comparing the two approximations

In total, we have values for both Total Debt and Total Long-term Funding for 87 banks.

On average Total Long-term Funding represents 80% of Total Debt.¹¹² However, there is quite some variability in the sample and for several banks the ratio is above 100%. Based on

¹⁰⁷ Including both hedging and non-hedging derivatives.

¹⁰⁸ Item includes loans from banks; debts securities in issue, the liability component of convertible bonds, and other borrowed funds.

¹⁰⁹ Subordinated loans and debt including any dated hybrid instruments.

¹¹⁰ Including both trading and hedging derivatives.

¹¹¹ Short positions, repos; short-term notes and other financial liabilities classified as held for trading.

this comparison we would expect the implicit subsidy estimate based on Total Long-term Funding to be lower than the estimate based on Total Debt.

¹¹² The ratio of Total Funding to Total Financial Liabilities is around 100% for all the banks.

Appendix G: Implicit subsidy versus pre-impairment operating profit

The aggregated pre-impairment operating profit by country is presented in Figure G.1. The total pre-impairment operating profit for the whole sample was EUR 197.5 billion and EUR 175.5 billion, in 2011 and 2012, respectively. The implicit subsidy in 2011 is estimated to be EUR 68 – 94 billion for the banks in our sample with profit data available in SNL. For 2012, the estimate is EUR 56 – 82 billion. So the implicit subsidy was 35-50% and 30-45% of pre-impairment operating profit in 2011 and 2012, respectively.

Figure G.1: Aggregated pre-impairment operating profit (EUR billion) country-by-country

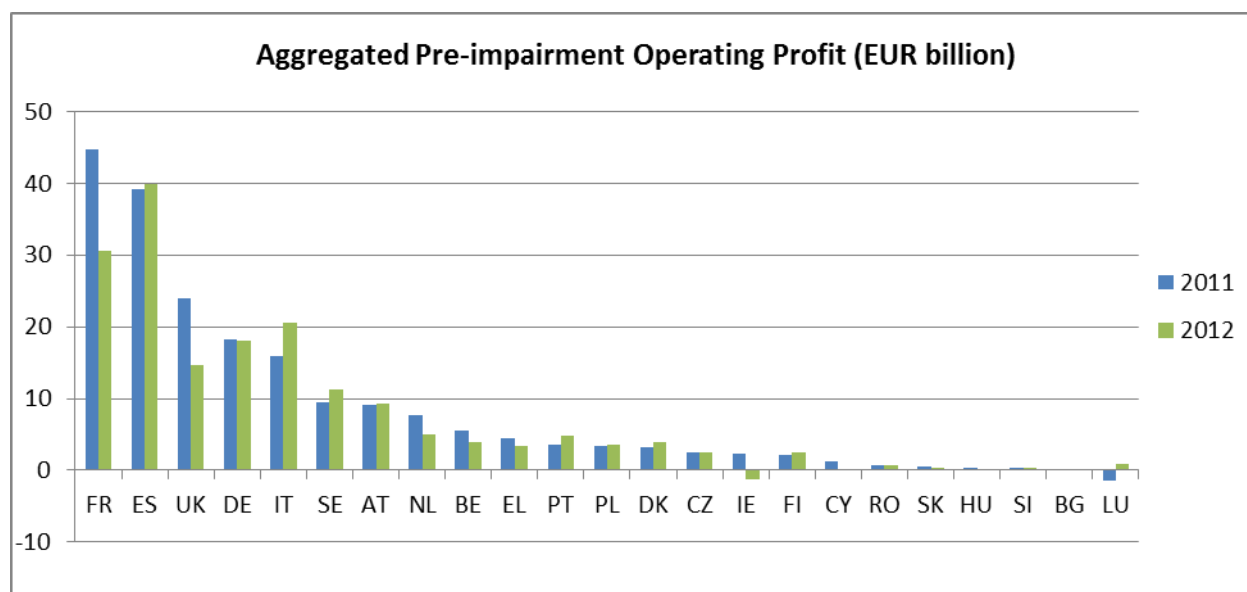

Source: SNL and own calculations

Country-by-country the implicit subsidy as a percentage of pre-impairment operating profit is highest for Sweden, Germany, Belgium, France and UK, see Figure G.2 and Figure G.3. The numbers indicate that the implicit subsidy can be quite significant for the banking system. One should of course be careful when analysing these results and ideally the implicit subsidy as well as the profit should be estimated over a longer period of time.

Figure G.2: Aggregated implicit subsidy (% of Pre-impairment Operating Profit) based on Total Debt

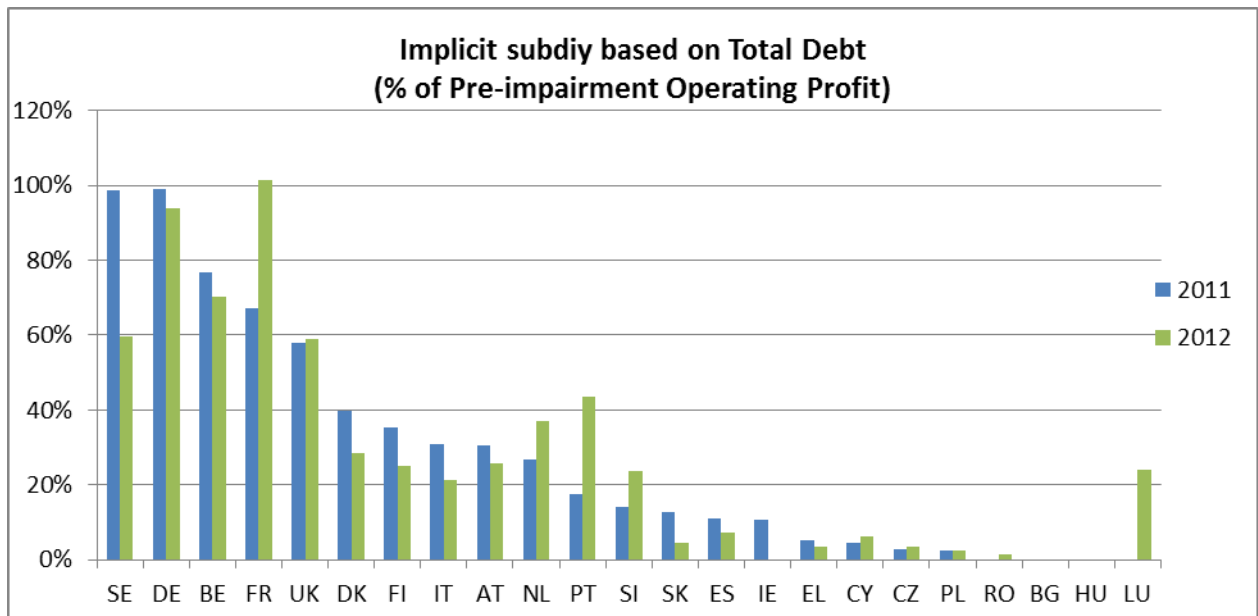

Source: SNL and own calculations

Figure G.3: Aggregated implicit subsidy (% of Pre-impairment Operating Profit) based on Total Long-term funding

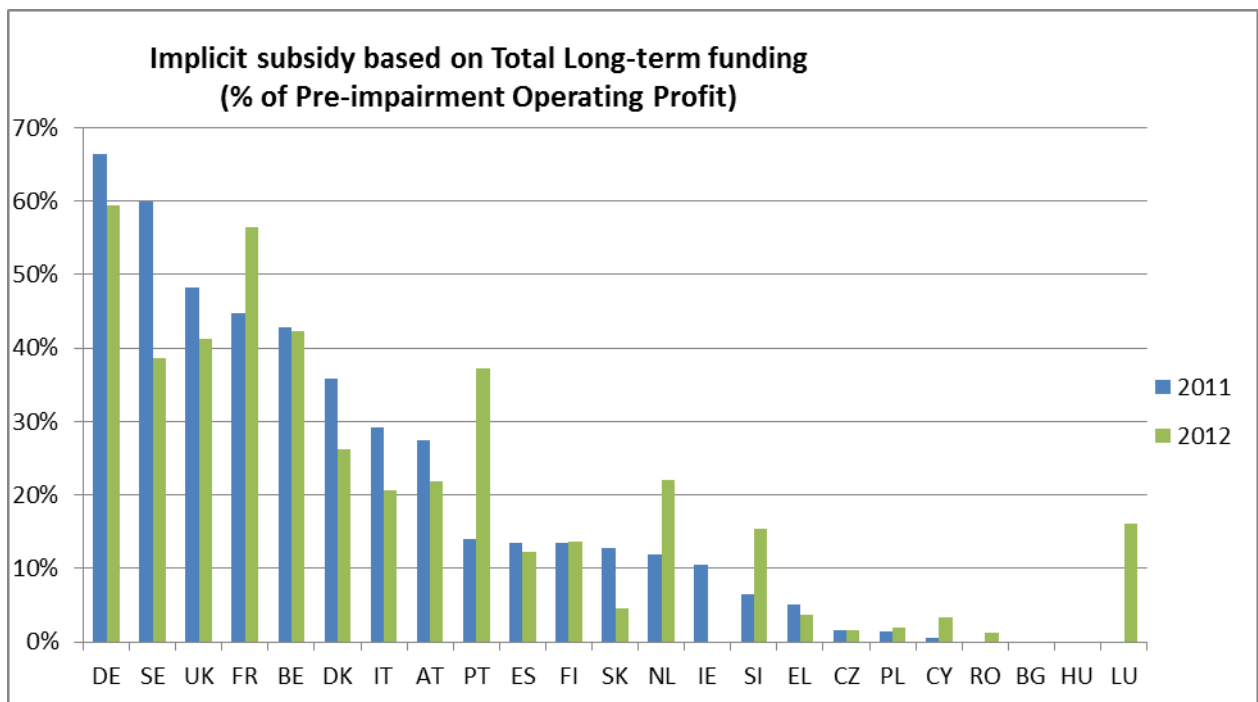

Source: SNL and own calculations

Appendix H: Implicit subsidy versus bank characteristics

The present Appendix summarizes the comparison of the relative size of the implicit subsidy with several balance sheet variables. We report here the graphs for the implicit subsidy estimate based on 'Total Debt' as reported by SNL for 2012. The general conclusions remain valid also for 2011 and the other implicit subsidy estimate.

From Figure 21 we have observed that there is a positive relation between the size of the bank (total assets) and the size of the implicit subsidy. This result comes from the fact that the larger the bank is the larger is the amount of debt on its balance sheet. Taking the size of the balance sheet into account, we rescale the implicit subsidy by total assets, to facilitate comparison between the banks in our sample.

Comparing the ratio of implicit subsidy to total assets with the size of the bank, the positive relation reported in Figure 21, is not that profound anymore (see Figure H.1).

There seems to be no or a weak positive relation between the ratio of implicit subsidy to total assets and several risk measures (leverage, Tier 1 Capital (as % of total assets) and risk weighted assets (as % of total assets)), as reported in Figure H.2-H.4.

Finally, the share of trading (Assets Held for Trading as a % of Total Assets) seems not to influence the relative size of implicit subsidy (see Figure H.5).

Figure H.1: Implicit subsidy (as a % of Total Assets) versus Total Assets (end of 2012)

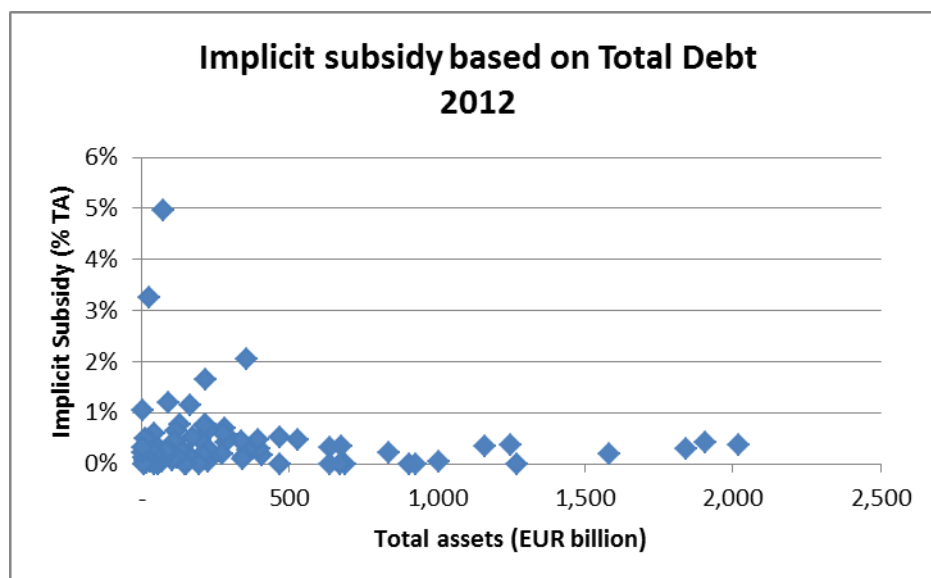

Figure H.2: Implicit subsidy (as a % of Total Assets) versus leverage (Total Assets over Total Equity) (end of 2012)

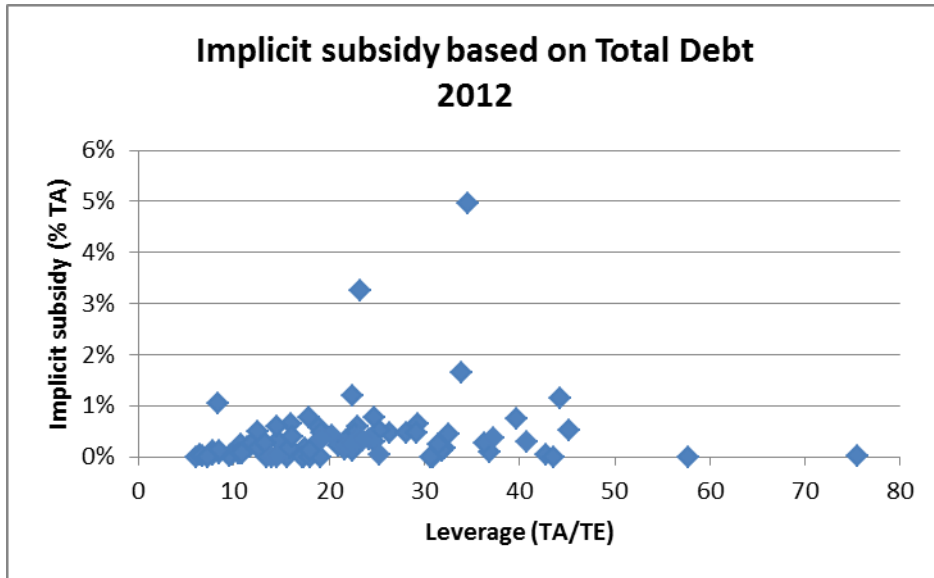

Figure H.3: Implicit subsidy (as a % of Total Assets) versus Tier 1 Capital (as a % of Total Assets) (end of 2012)

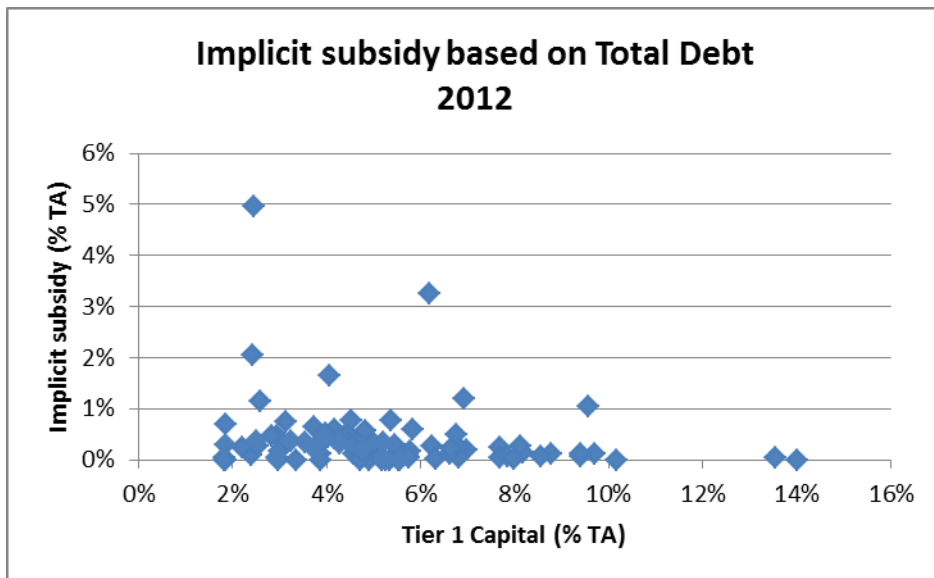

Figure H.4: Implicit subsidy (as a % of Total Assets) versus Risk Weighted Assets (as a % of Total Assets) (end of 2012)

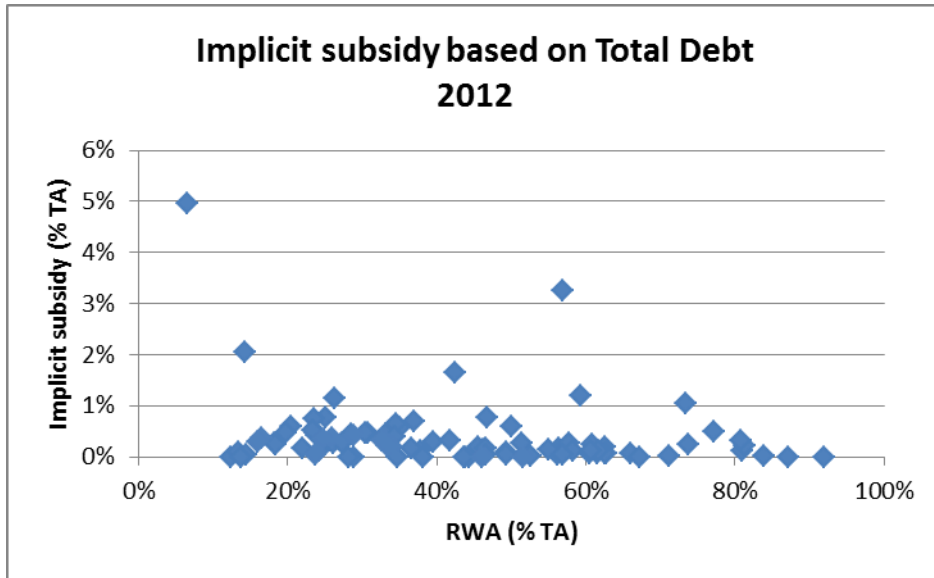
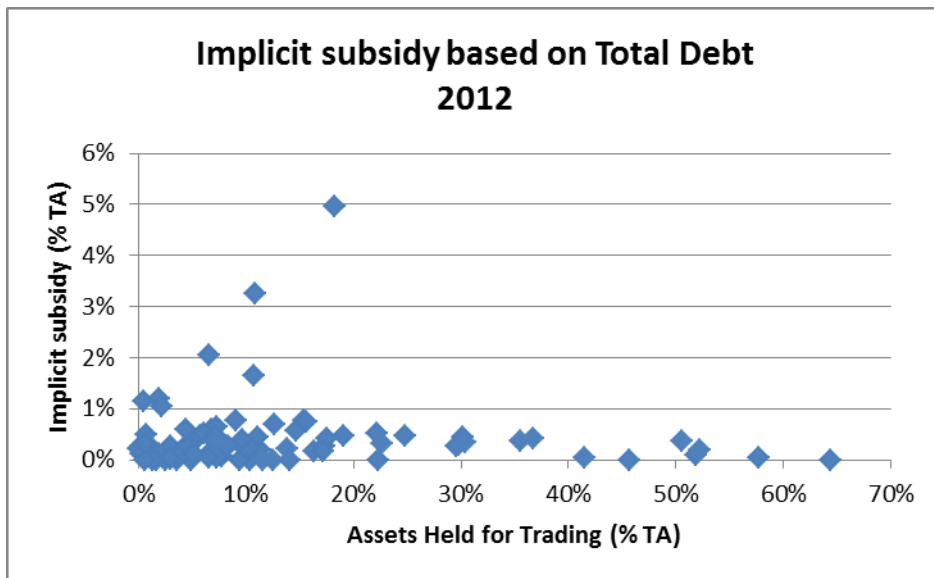

Figure H.5: Implicit subsidy (as a % of Total Assets) versus Assets Held for Trading (end of 2012)



Appendix I: SNL business model variables description

- Total assets: All assets owned by the company as of the date indicated, as carried on the balance sheet and defined under the indicated accounting principles.
- Assets Held for Trading: Trading portfolio assets are: assets acquired principally for the purpose of selling in the near term, assets that on initial recognition are part of a portfolio of identified financial instruments that are managed together and for which there is evidence of a recent actual pattern of short-term profit-taking, or derivative assets (except for a derivative that is designated as an effective hedging instrument).
- Total Deposits from Customers: Amounts in customers' banking deposits; any accounts subject to federal banking deposit insurance, including any portions in jumbo deposits that are not insured but subject to the FDIC deposit regulations.
- Total Deposits from Banks: Total deposits from banks.
- Total Equity: Equity as defined under the indicated accounting principles. Includes par value, paid in capital, retained earnings, and other adjustments to equity. Minority interest may be included, per relevant accounting standards.
- Risk Weighted Assets: Total risk-adjusted assets as reported by the company. For European banks, this includes transitional capital adjustments when available.
- Tier1 Capital: For OTS-regulated institutions it represents the amount of core capital as defined under the latest OTS guidelines at period-end. For FDIC-regulated institutions it represents the amount of Tier 1 capital as defined by the latest regulatory agency guidelines.
- Tier2 Capital: Tier 2 eligible capital as defined by the bank's domestic central bank.
- Net Loans to Banks: Net loans and advances made to banks after deducting any allowance for impairment.
- Net Loans to Customers: Total loans to customers, net of reserves for loan losses. Includes any loans held at amortised cost, available for sale, fair value through profit and loss and trading. For U.S. GAAP companies, this is total loans and finance leases outstanding, including those held for sale.
- Total Financial Liabilities: Total interest accruing liabilities
- Operating Income: Total operating income from banking, insurance and asset management
- Net Interest Income: Interest income less interest expense before the provision for loan losses.
- Net Fee & Commission Income: Revenue from services to customers, net of expense from third parties related to services provided to the company.
- Derivative Liabilities: Total negative replacement values of hedging and non-hedging derivatives. A derivative is a financial instrument with all of the following three characteristics: its value changes in response to the change in an underlying variable; it requires no initial net investment or an initial net investment that is smaller than would be required for other contracts that would be expected to have a similar response to changes in market factors; it is settled at a future date. For European Insurers, this also includes liabilities held at fair value through profit and loss.

- Short Term Funding: Principal amount of debt payable within the next calendar year, including the current portion of long-term debt.
- Derivatives Assets: Derivatives Held for Trading (Derivatives with positive replacement values not identified as hedging or embedded derivatives. A derivative is a financial instrument with all of the following three characteristics: its value changes in response to the change in an Underlying variable; it requires no initial net investment or an initial net investment that is smaller than would be required for other contracts that would be expected to have a similar response to changes in market factors; it is settled at a future date.) and Derivatives Identified as Positive Hedges (Derivatives with positive replacement values accounted for under fair value hedge accounting, cash flow hedge accounting, or hedging of a net investment in a foreign operation. This includes fair value changes associated with hedging instruments.)

Appendix J: Marginal effects in Probit regression

Let AX represents the average bank characteristics with ℓ -th average characteristic denoted as AX_ℓ . We wish to measure the impact that a change of the ℓ -th characteristic by dAX_ℓ (or ΔAX_ℓ if the variable is discrete) has on the probability that the average bank receives an UPLIFT* equal to $j=0, \dots, m$, the other variables being held constant. A first-order approximation around AX gives:

$$P(\text{UPLIFT}^*=j|AX + dAX_\ell) = P(\text{UPLIFT}^*=j|AX) + dAX_\ell [dP(\text{UPLIFT}^*=j|AX)/dAX_\ell]$$

where $dP(\text{UPLIFT}^*=j|AX)/dAX_\ell$ represents the derivative of the probability that the average bank UPLIFT* belongs to category j when the characteristic ℓ changes by an amount equal to dAX_ℓ (the so called marginal effect). In the Probit framework, this derivative verifies:

$$dP(\text{UPLIFT}^*=0|AX)/dAX_\ell = -\beta_\ell \Phi(\mu_1 - AX' \beta)$$

$$dP(\text{UPLIFT}^*=j|AX)/dAX_\ell = -\beta_\ell [\Phi(\mu_{j+1} - AX' \beta) - \Phi(\mu_j - AX' \beta)], j = 1, \dots, m-1$$

$$dP(\text{UPLIFT}^*=m|AX)/dAX_\ell = \beta_\ell \Phi(\mu_m - AX' \beta)$$

where β_ℓ is the coefficient associated to the ℓ -th characteristic and Φ is the standard normal density. The discrete case is trivially obtained. Hence, when the explanatory variables depart from average values, negative values of β_ℓ emphasize the lower tail and positive values the upper one. It can be verified that the marginal effects of dAX_ℓ on the probability to belong to each category $j=0, \dots, m$ sum to 0 over all categories, which does not occur under the linear probabilistic model.